

# FAN5622 / FAN5624 / FAN5626

## Linear LED Drivers with Single-Wire Digital Interface

### Features

- Family of Three Linear Current-Sink LED Drivers that Support 2, 4, or 6 LED Outputs
- Current Sink Driver for Each LED Output:
  - 30mA Maximum Output Current
  - 50mV Drop-out at 15mA I<sub>OUT</sub>
  - Better than 3% Matching between Channels
  - External R<sub>SET</sub>
- Single-Wire Digital Control Interface for Easy Programming
  - 32 Linear Steps of Dimming Control
- Less than 1μA Shut-Down Current
- Short-Circuit, Under-Voltage, and Thermal Protection
- Wide Input Voltage Range: 2.7 to 5.5V
- Small Form-Factor Packages:
  - FAN5622: 6-pin Super SOT23
  - FAN5624: 10-lead 1.4x1.8x0.55mm UMLP
  - FAN5626: 10-lead 1.6x2.1x0.55mm MicroPak™ MLP

### Applications

- Mobile Handsets
- Mobile Internet Devices
- PMP and MP3 Players
- LCD Modules

### Description

The FAN5622, FAN5624, and FAN5626 are two-, four-, and six- channel current-sink linear LED drivers used to backlight the main LCD displays or keypads in mobile electronics, such as cellular phone handsets.

A very low dropout of 50mV allows driving LEDs without any inductors or switch capacitors. The brightness levels of the LED outputs are programmed through single-wire digital control interface. The user can program 32 linear dimming steps and turn on and off the LEDs through this interface by applying digital pulses.

The FAN562x family of linear LED drivers provides high efficiency due to the low drop-out voltage of the LED driver. Good matching between different channels of LED output is provided across the entire 32 dimming steps. These LED drivers also integrate short circuit, under-voltage, and thermal protection to ensure for a more robust solution.

The FAN5622, FAN5624, and FAN5626 are available in very small form-factor packages: 6-pin Super SOT23, 10-lead UMLP, and 10-lead MicroPak™ MLP, respectively.

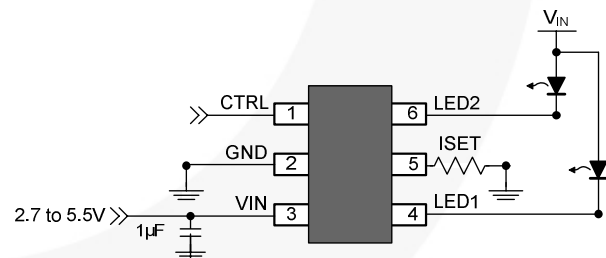

Figure 1. Typical Application of FAN5622

### Ordering Information

Part Number	# of Channels	Temperature Range	Package	Packing
FAN5622SX	2	-40 to 85°C	6-Lead SSOT23	Tape and Reel
FAN5624UMPX	4	-40 to 85°C	10-Lead UMLP	Tape and Reel
FAN5626LX	6	-40 to 85°C	10-Lead MicroPak™ MLP	Tape and Reel

### Applications Diagrams

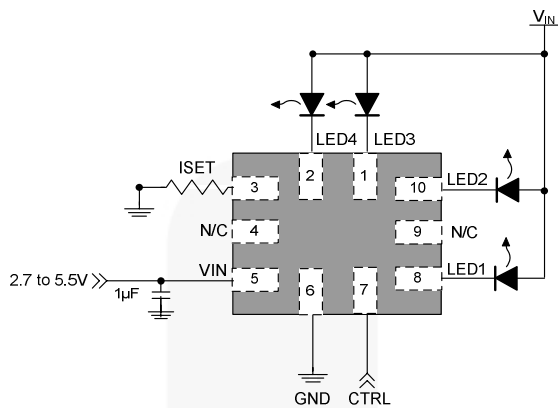

Figure 2. FAN5624 Typical Application for 4 LEDs

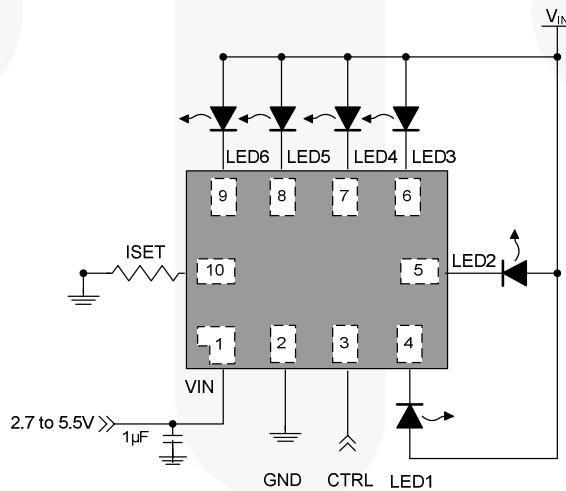

Figure 3. FAN5626 Typical Application for 6 LEDs

### Block Diagram

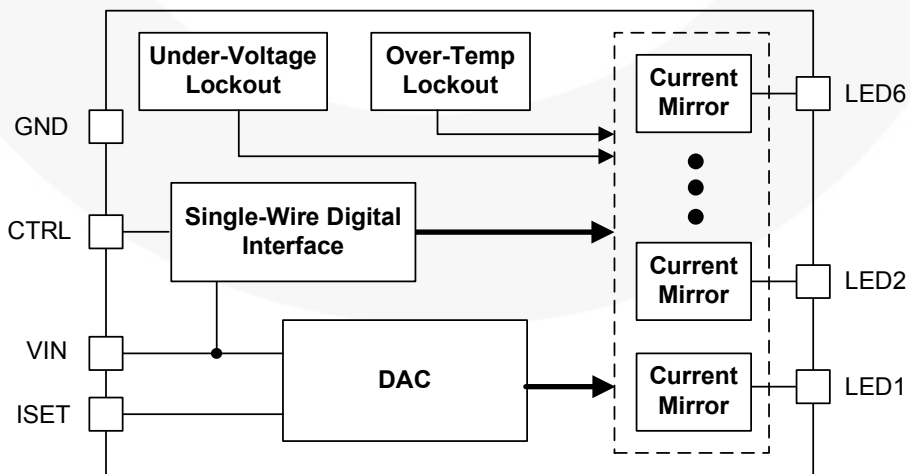

Figure 4. Block Diagram

## Pin Configuration

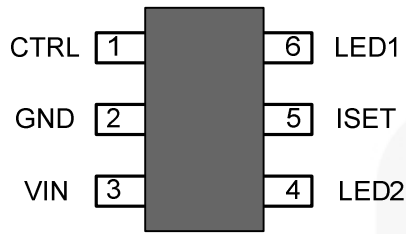

Figure 5. FAN5622: 6-Pin SSOT23, Top View

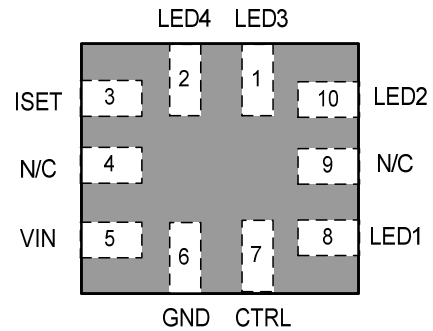

Figure 6. FAN5624: 10-Lead UMLP, Top View

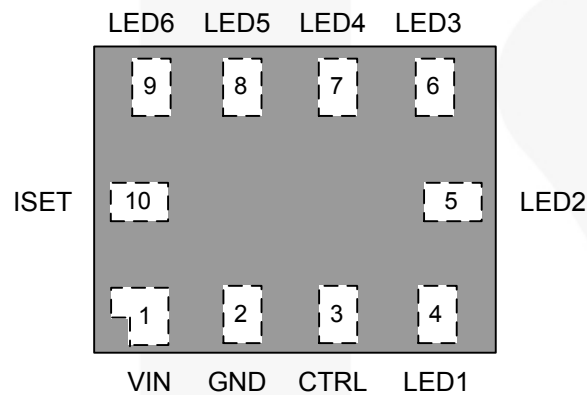

Figure 7. FAN5626: 10-Lead MicroPak™ MLP, Top View

## Pin Definitions

Pin #			Name	Description
FAN5622 SSOT23-6	FAN5624 UMLP10	FAN5626 MicroPak MLP10		
3	5	1	VIN	<b>Input Voltage.</b> Connect to 2.7-5.5V <sub>DC</sub> input power source.
2	6	2	GND	<b>Ground</b>
5	3	10	ISET	<b>LED Current Setting.</b> Full-scale LED current is set by tying this pin through a resistor ( $R_{SET}$ ) to GND.
1	7	3	CTRL	<b>Control</b> pin. Program dimming levels by driving pin with digital pulses. This pin cannot be left floating.
6	8	4	LED1	<b>LED Cathode #1.</b> LED current sink output.
4	10	5	LED2	<b>LED Cathode #2.</b> LED current sink output.
	1	6	LED3	<b>LED Cathode #3.</b> LED current sink output.
	2	7	LED4	<b>LED Cathode #4.</b> LED current sink output.
		8	LED5	<b>LED Cathode #5.</b> LED current sink output.
		9	LED6	<b>LED Cathode #6.</b> LED current sink output.
	4, 9		N/C	<b>No Connect</b>

## Absolute Maximum Ratings

Stresses exceeding the absolute maximum ratings may damage the device. The device may not function or be operable above the recommended operating conditions and stressing the parts to these levels is not recommended. In addition, extended exposure to stresses above the recommended operating conditions may affect device reliability. The absolute maximum ratings are stress ratings only.

Symbol	Parameter	Min.	Max.	Units
$V_{CC}$	VIN Pin	-0.3	6.0	V
	Other Pins <sup>(1)</sup>	-0.3	$V_{IN} + 0.3$	V
ESD	Electrostatic Discharge Protection Level	Human Body Model per JESD22-A114	3.0	kV
		Charged Device Model per JESD22-C101	1.5	kV
$T_J$	Junction Temperature	-40	+150	°C
$T_{STG}$	Storage Temperature	-65	+150	°C
$T_L$	Lead Soldering Temperature, 10 Seconds		+260	°C

### Note:

1. Lesser of 6.0V or  $V_{IN}+0.3V$ .

## Recommended Operating Conditions

The Recommended Operating Conditions table defines the conditions for actual device operation. Recommended operating conditions are specified to ensure optimal performance to the datasheet specifications. Fairchild does not recommend exceeding them or designing to absolute maximum ratings.

Symbol	Parameter	Min.	Max.	Units
$V_{IN}$	Power Supply Voltage Range	2.7	5.5	V
$T_A$	Operating Ambient Temperature Range	-40	+85	°C
$T_J$	Operating Junction Temperature Range	-40	+125	°C
$I_{LED(FS)}$	Full-Scale LED Current	5	30	mA

## Thermal Properties

Junction-to-ambient thermal resistance is a function of application and board layout. This data is measured with boards in accordance to JEDEC standard JESD51. Special attention must be paid not to exceed junction temperature  $T_{J(max)}$  at a given ambient temperature  $T_A$ .

Symbol	Parameter	Typical	Units
$\theta_{JA\_SSOT23-6}$	Junction-to-Ambient Thermal Resistance, SSOT23-6 Package	235	°C/W
$\theta_{JA\_UMLP10}$	Junction-to-Ambient Thermal Resistance, UMLP10 Package <sup>(2)</sup>	287	°C/W
$\theta_{JA\_MicroPAK\_MLP10}$	Junction-to-Ambient Thermal Resistance, MicroPak™ MLP10 package <sup>(3)</sup>	220	°C/W

### Notes:

2. Recommended not to exceed 132mW of maximum power dissipation.
3. Recommended not to exceed 198mW of maximum power dissipation.

## Electrical Specifications

$V_{IN} = 2.7V$  to  $5.5V$ ,  $R_{SET} = 19.10k\Omega$ ,  $T_A = -40^\circ C$  to  $+85^\circ C$ ,  $V_f = 2.5V$  to  $[3.5V$  or  $V_{IN} - 0.1V]$ , whichever is smaller. Typical values are at  $T_A = 25^\circ C$ ,  $V_{IN} = 3.6V$ , and  $V_f = 3.2V$ .

Symbol	Parameter	Conditions	Min.	Typ.	Max.	Units
<b>Power Supplies</b>						
$I_{SD}$	Shutdown Supply Current	$V_{IN} = 3.6V$ , CTRL = 0		0.3	1.0	$\mu A$
$I_{IN}$	Operating Supply Current	FAN5622: $V_{IN} = 3.6V$ , $I_{LED} = 0mA$		0.4	0.8	mA
		FAN5624: $V_{IN} = 3.6V$ , $I_{LED} = 0mA$		0.6	1.0	mA
		FAN5626: $V_{IN} = 3.6V$ , $I_{LED} = 0mA$		0.8	1.2	mA
$I_{IH}$	Control Pin Input Current	CTRL = 1.8V		1	250	nA
$V_{UVLO}$	Under-Voltage Lockout Threshold	$V_{IN}$ Rising		2.50	2.70	V
		$V_{IN}$ Falling	2.10	2.30	2.50	V
<b>Regulation</b>						
$I_{FS\_LEDx(MAX)}$	Full-Scale LED Output Current	$I_{LEDx} = 30mA$ ; $x = 1$ to $6$	5		30	mA
$I_{LED}$	Absolute Current Accuracy	$V_{IN} = 2.85V - 4.5V$ ; $V_{CATH} = 0.15$ to $(1.2V$ or $V_{IN} = 2.55V)$ , whichever is smaller; Full-Scale Current 5-30mA, $T_A = 25^\circ C$	-10		+10	%
$I_{LED\ MATCH}$	LED Current Matching <sup>(4)</sup>	$I_{LEDx} = 15mA$ ; $V_{\_LEDx} = 0.4V$ , $T_A = 25^\circ C$	-3		+3	%
$V_{ISET}$	ISET Drive Voltage	$9.53k\Omega \leq R_{SET} \leq 56.2k\Omega$		1.20		V
$I_{RATIO}$	Current Mirror Ratio from ISET Pin	$9.53k\Omega \leq R_{SET} \leq 56.2k\Omega$		240		
$\Delta I_{OUT\_LOAD}$	IOUT Load Regulation	$V_{IN} = 3.6V$ , $I_{LEDx} = 15mA$ , LED $V_f = 2.7$ to $3.5V$ ,	-3		+3	%
$\Delta I_{OUT\_LINE}$	IOUT Line Regulation	$V_{IN} = 2.7$ to $4.8V$ , $I_{LEDx} = 15mA$ , $V_{CATH} = 0.5V$	-4		+4	%
$V_{DROPOUT}$	Dropout Voltage	$V_{IN} = 3.6V$ ; $I_{LED} = 15mA$ , -10% $I_{LED}$ Drop		50		mV
		$V_{IN} = 3.6V$ ; $I_{LED} = 30mA$ , -10% $I_{LED}$ Drop		60		
TSD	Thermal Shutdown	Rising Temperature at Junction		150		$^\circ C$
		Hysteresis		20		
<b>Logic Input (CTRL)</b>						
$V_{IH}$	HIGH-Level Input Voltage		1.2			V
$V_{IL}$	LOW-Level Input Voltage				0.4	V
$T_{LO}$	CTRL LOW Time for Dimming	$V_{IN} = 3.6V$ ; See Figure 17	0.5		300	$\mu s$
$T_{HI}$	Time Delay between Steps	$V_{IN} = 3.6V$ ; See Figure 17	0.5			$\mu s$
$T_{ON}$	CTRL HIGH to Turn-On Delay	$V_{IN} = 3.6V$ ; See Figure 17		250		$\mu s$
$T_{SD}$	CTRL LOW, Shutdown Pulse Width	$V_{IN} = 3.6V$ ; from Falling Edge of CTRL	1			ms

### Note:

4. For the two, four, and six LED current sinks of FAN5622, FAN5624, and FAN5626 respectively; the following are determined: the maximum sink current of the two, four, and six LED outputs (MAX); the minimum sink current of the two, four, and six outputs (MIN); and the average sink current (AVG). For all of the LED outputs, two matching numbers are calculated:  $(MAX - AVG) / AVG$  and  $(AVG - MIN) / AVG$ . The largest number of the two (worst case) is considered the matching figure for the part. The matching figure for a given part is considered to be the highest matching figure of all LED outputs. The typical specification provided is the most likely norm of the matching figure for all parts.

## Typical Performance Characteristics

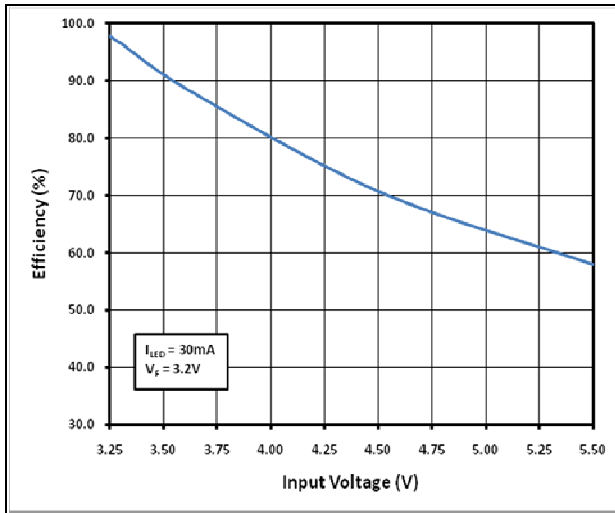

Figure 8. Efficiency vs. Input Voltage where LED  $V_F=3.2V$

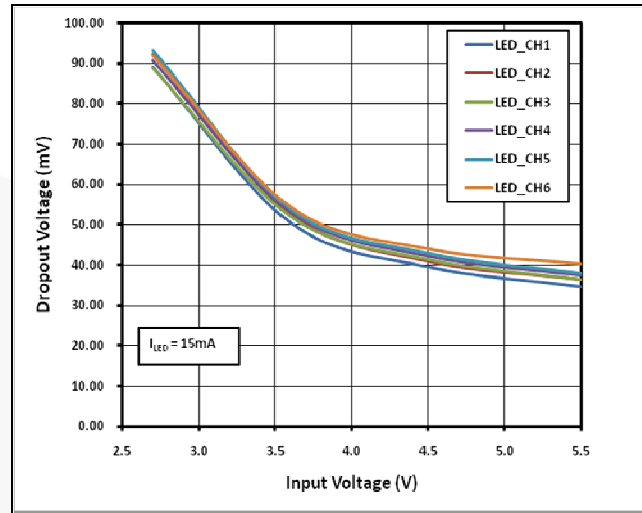

Figure 9. Dropout Voltage vs. Input Voltage

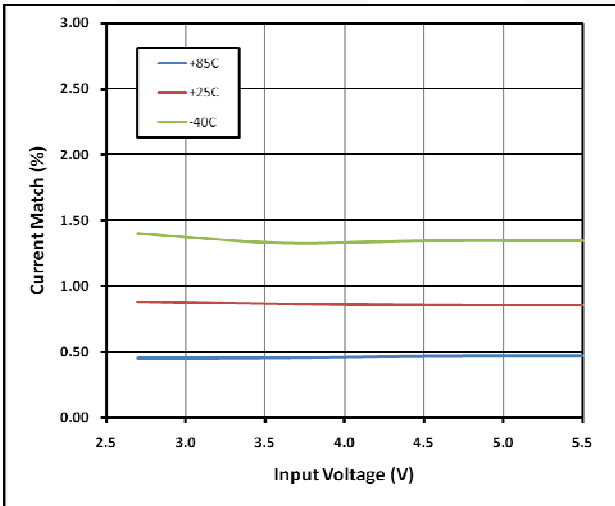

Figure 10. Current Match of Channels vs. Input Voltage

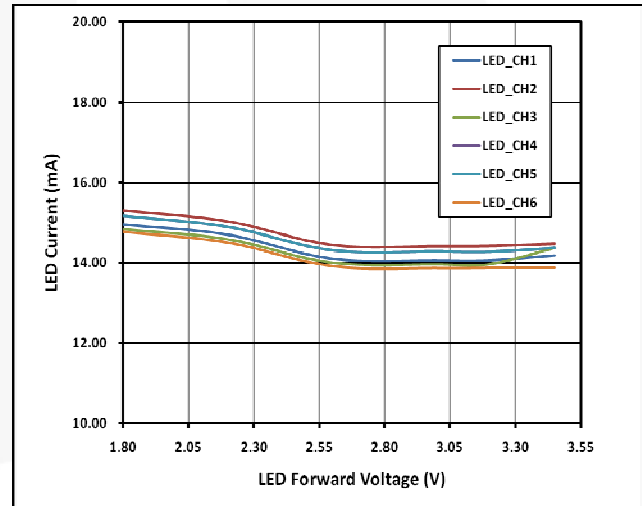

Figure 11. Load Regulation at 15mA/Output

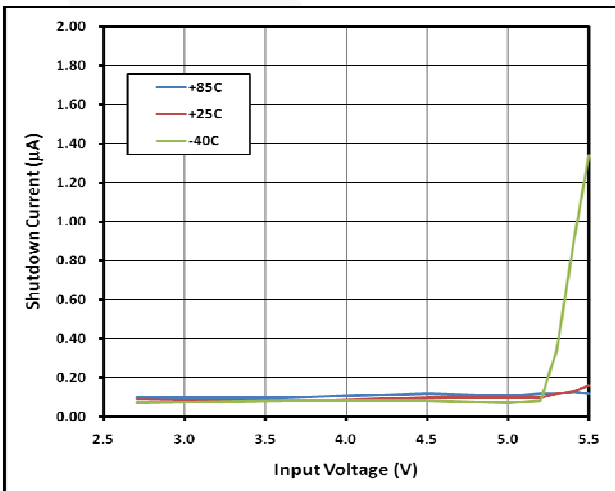

Figure 12. Shutdown Current vs. Input Voltage

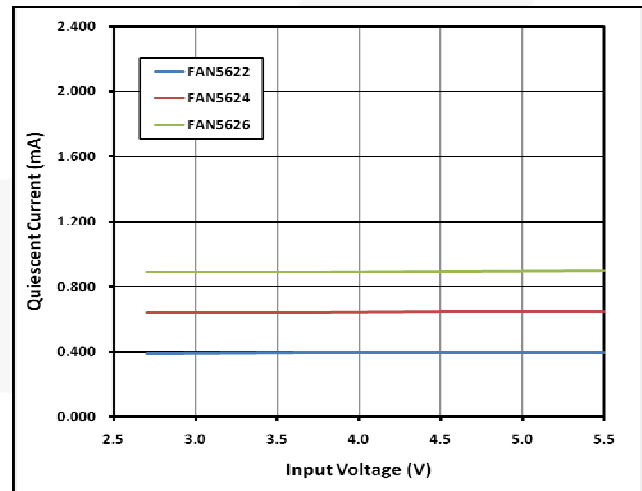

Figure 13. Quiescent Current vs. Input Voltage

### Typical Performance Characteristics

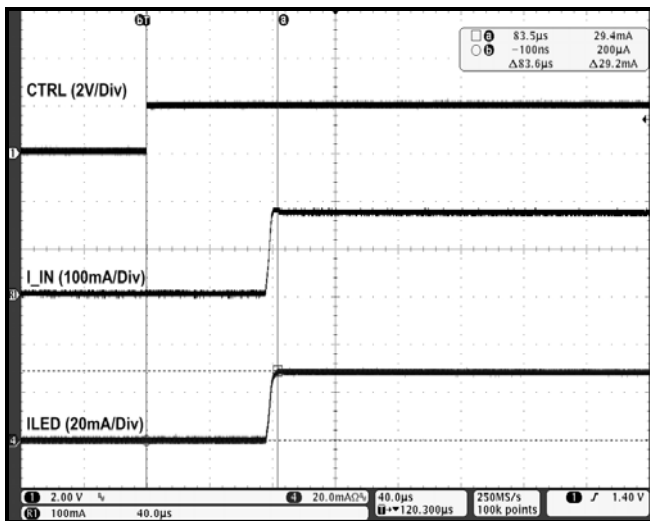

Figure 14. Startup Waveform for FAN5626

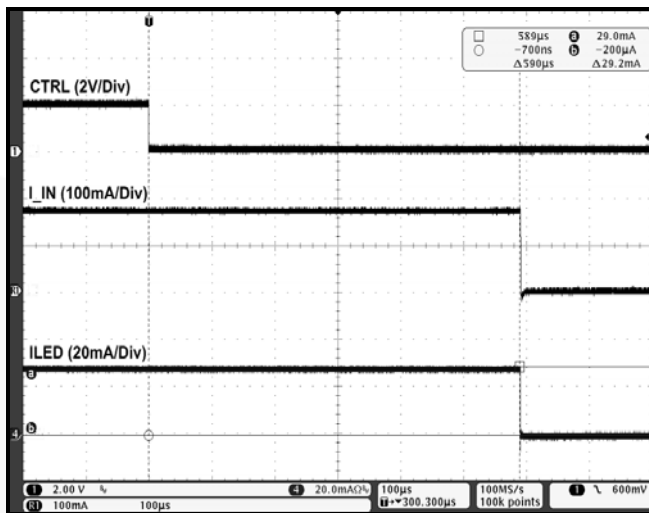

Figure 15. Shutdown Waveform for FAN5626

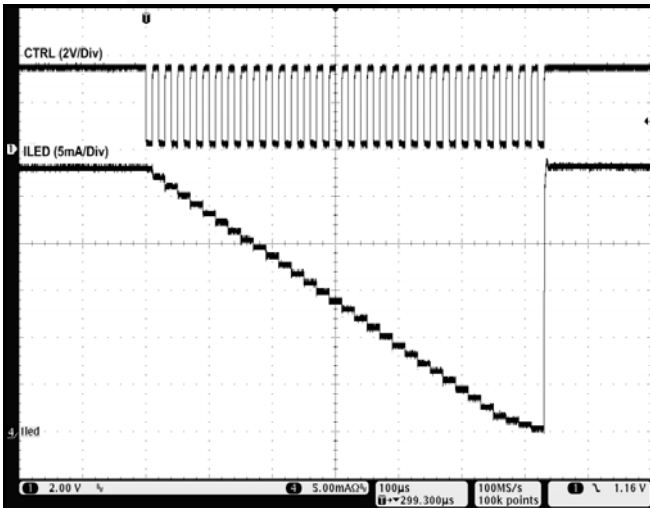

Figure 16. Dimming Operation

## Circuit Description

The FAN5622, FAN5624, and FAN5626 are a family of current-sink linear LED driver ICs able to drive two, four, and six LEDs respectively. These three devices are powered directly from 2.7V to 5.5V supply and all the channels are controlled via the integrated current sinks from the external power source. Designed with a very low drop-out voltage, the FAN562x products can operate close to the input supply voltage without the need for additional inductive boost or capacitive switching circuitry.

All three devices require only two additional discrete passive components: a single 1 $\mu$ F input ceramic capacitor and a resistor ( $R_{SET}$ ) to set the maximum current for the LEDs. Each current-sink output provides constant current and can drive the LEDs up to 30mA. Fairchild Semiconductor's TinyWire™ single-wire digital interface enables these LED drivers to program the brightness level of the LEDs in 32 linear steps.

### Setting Maximum Current

The maximum LED current of the FAN5622, FAN5624, and FAN5626 is programmed by an external resistor called  $R_{SET}$ . The maximum full-scale LED current for all three LED drivers is 30mA and it can go as low as 5mA. The FAN562x products also operate below 5mA full-scale LED current by using a larger  $R_{SET}$  value. However, the LED channel accuracy and matching specifications are guaranteed. Table 1 shows the  $R_{SET}$  resistor values for several full-scale current levels.

**Table 1. Maximum LED Current Settings by Resistor**

$I_{LED}$ (mA)	$R_{SET}$ (k $\Omega$ )
5	56.20
10	28.70
15	19.10
20	14.30
25	11.50
30	9.53

### Digital Interface & Dimming Control

The FAN5622, FAN5624, and FAN5626 implement a simple single-wire digital interface to program the LED brightness to one of thirty two (32) levels spaced in linear steps. To maintain the brightness of the LEDs at a specific dimming level, the digital pulse signal to the CTRL pin should be held HIGH for that last pulse. It is held HIGH for as long as desired to keep the LEDs illuminated at that specific brightness level.

Table 2 outlines the dimming levels while Figure 17 shows how to change the dimming levels.

**Table 2. Brightness Control Levels ( $R_{SET} = 19.10k\Omega$ )**

Dimming Level	Current Level	$I_{LED}$ (mA)
1	1.67%	0.25
2	3.33%	0.50
3	5.00%	0.75
4	6.67%	1.00
5	10.00%	1.50
6	13.33%	2.00
7	16.67%	2.50
8	20.00%	3.00
9	23.33%	3.50
10	26.67%	4.00
11	30.00%	4.50
12	33.33%	5.00
13	36.67%	5.50
14	40.00%	6.00
15	43.33%	6.50
16	46.67%	7.00
17	50.00%	7.50
18	53.33%	8.00
19	56.67%	8.50
20	60.00%	9.00
21	63.33%	9.50
22	66.67%	10.00
23	70.00%	10.50
24	73.33%	11.00
25	76.67%	11.50
26	80.00%	12.00
27	83.33%	12.50
28	86.67%	13.00
29	90.00%	13.50
30	93.33%	14.00
31	96.67%	14.50
32	100.00%	15.00



## Digital Dimming Control

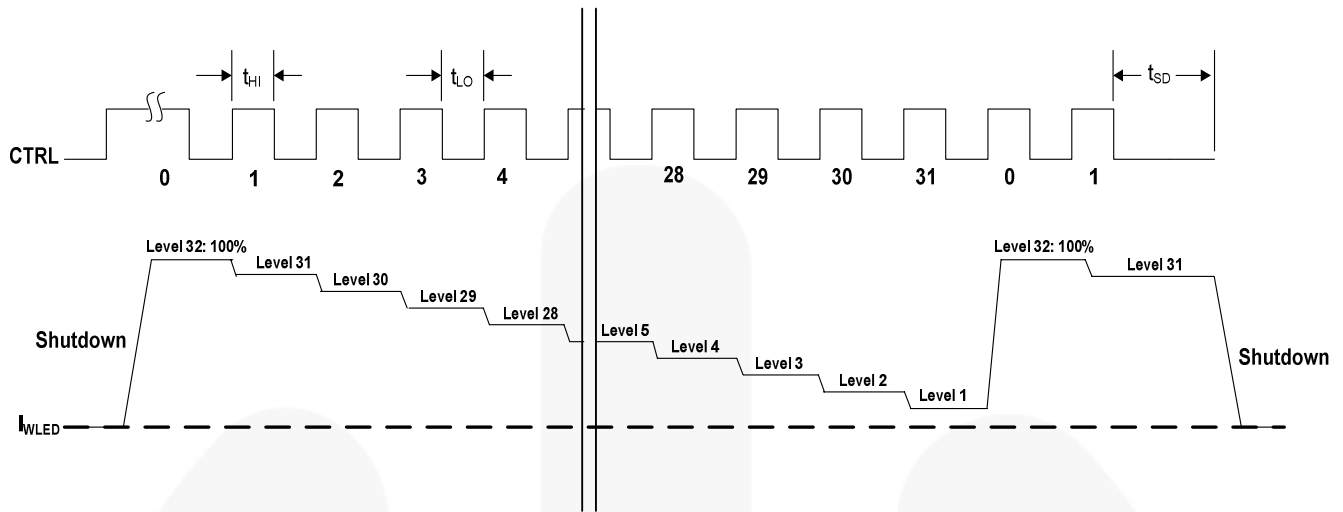

Figure 17. Digital Pulse Dimming Control Diagram

## Physical Dimensions

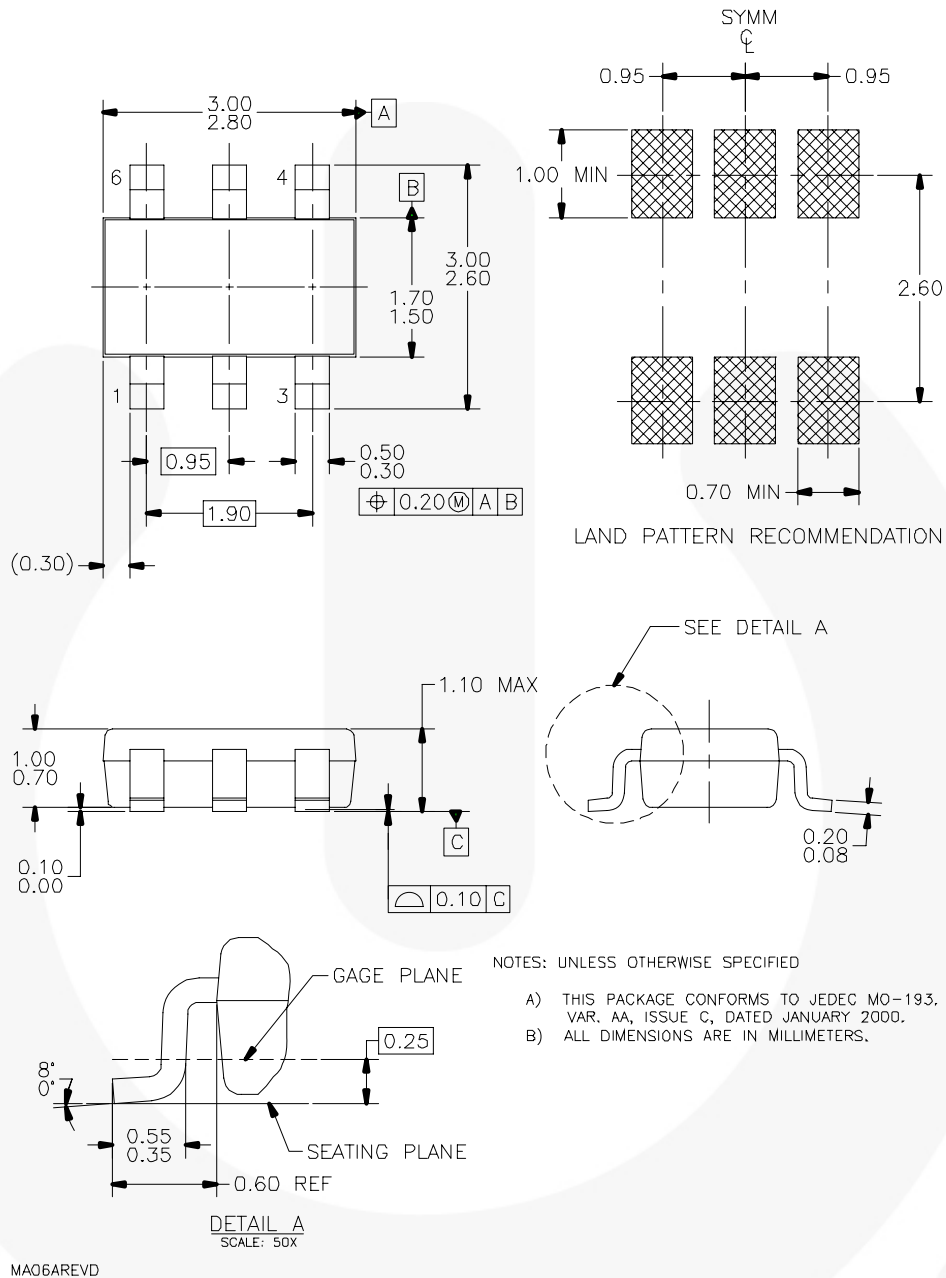
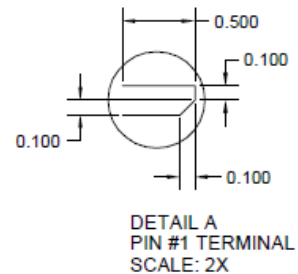
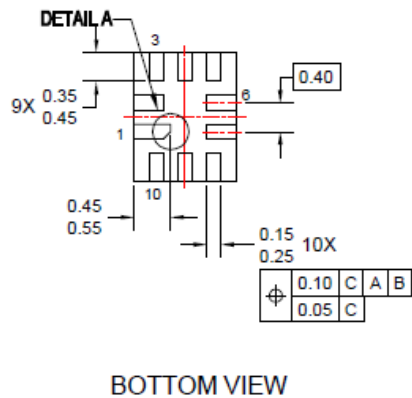
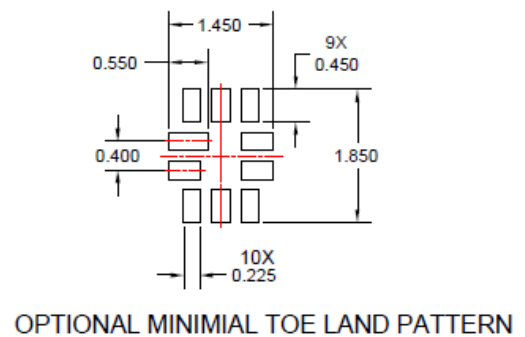
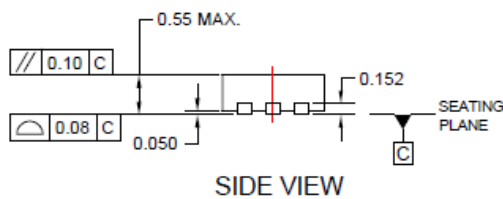
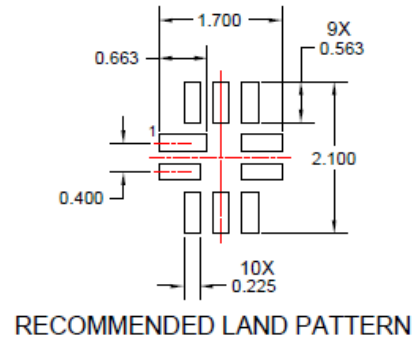
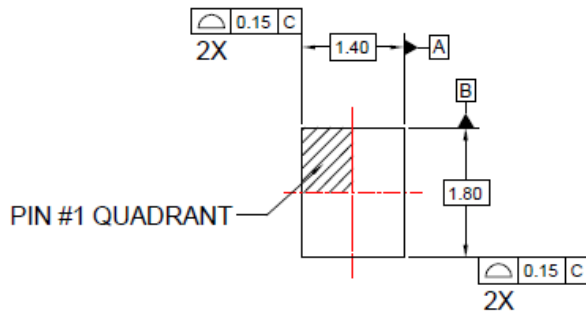

Figure 18. FAN5622: 6-Lead SSOT23

Package drawings are provided as a service to customers considering Fairchild components. Drawings may change in any manner without notice. Please note the revision and/or date on the drawing and contact a Fairchild Semiconductor representative to verify or obtain the most recent revision. Package specifications do not expand the terms of Fairchild's worldwide terms and conditions, specifically the warranty therein, which covers Fairchild products.

Always visit Fairchild Semiconductor's online packaging area for the most recent package drawings:  
<http://www.fairchildsemi.com/packaging/>

## Physical Dimensions (Continued)



### NOTES:

- A. DIMENSIONS ARE IN MILLIMETERS.
- B. DIMENSIONS AND TOLERANCES PER ASME Y14.5M, 1994
- C. DRAWING FILENAME: UMLP10Arev2

Figure 19. FAN5624: 10-Lead UMLP

Package drawings are provided as a service to customers considering Fairchild components. Drawings may change in any manner without notice. Please note the revision and/or date on the drawing and contact a Fairchild Semiconductor representative to verify or obtain the most recent revision. Package specifications do not expand the terms of Fairchild's worldwide terms and conditions, specifically the warranty therein, which covers Fairchild products.

Always visit Fairchild Semiconductor's online packaging area for the most recent package drawings:  
<http://www.fairchildsemi.com/packaging/>

## Physical Dimensions (Continued)

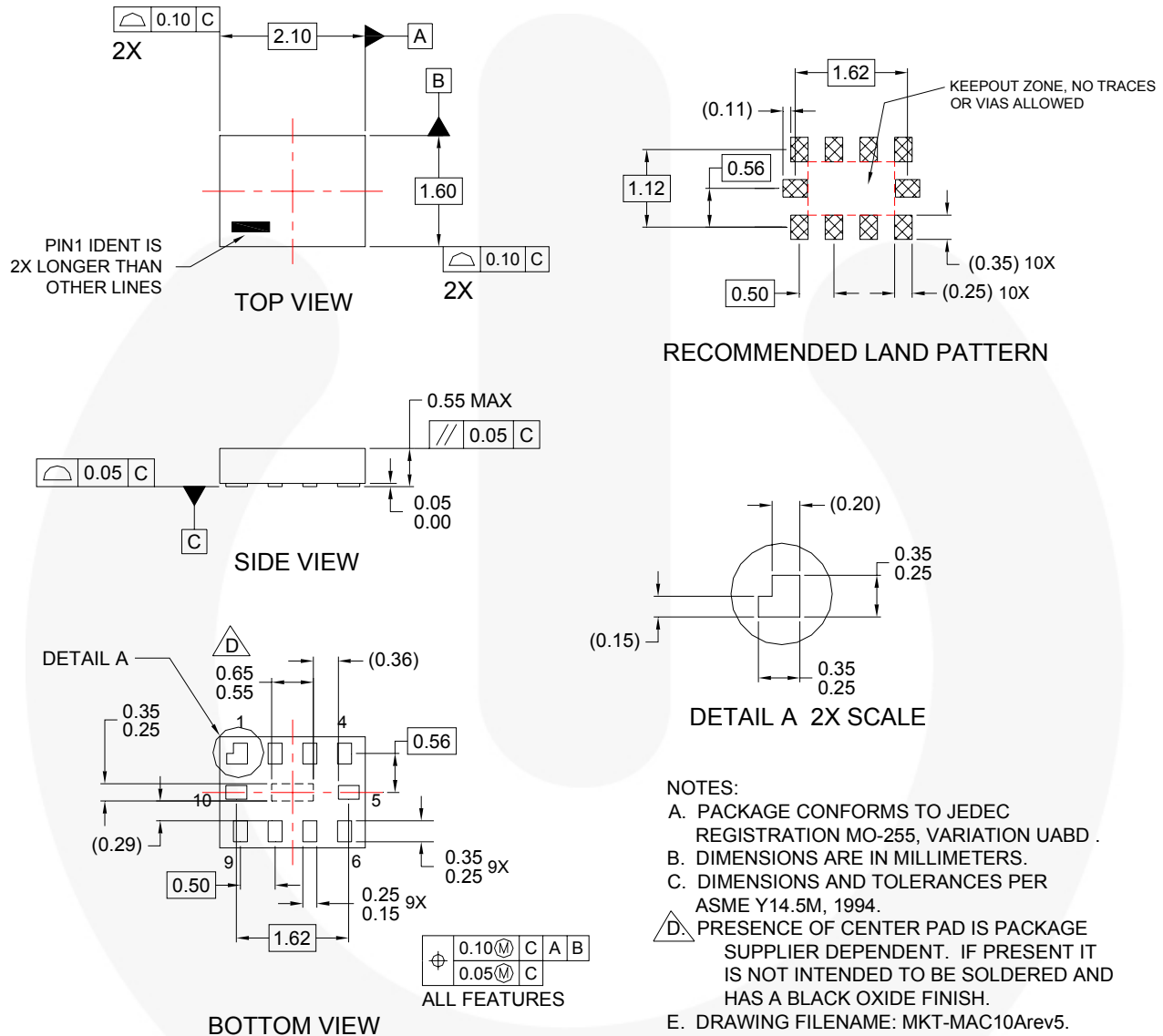

Figure 20. FAN5626: 10-Lead MicroPak™ MLP

Package drawings are provided as a service to customers considering Fairchild components. Drawings may change in any manner without notice. Please note the revision and/or date on the drawing and contact a Fairchild Semiconductor representative to verify or obtain the most recent revision. Package specifications do not expand the terms of Fairchild's worldwide terms and conditions, specifically the warranty therein, which covers Fairchild products.

Always visit Fairchild Semiconductor's online packaging area for the most recent package drawings:

<http://www.fairchildsemi.com/packaging/>



**TRADEMARKS**

The following includes registered and unregistered trademarks and service marks, owned by Fairchild Semiconductor and/or its global subsidiaries, and is not intended to be an exhaustive list of all such trademarks.

AccuPower™  
 Auto-SPM™  
 Build it Now™  
 CorePLUS™  
 CorePOWER™  
 CROSSVOLT™  
 CTL™  
 Current Transfer Logic™  
 DEUXPEED®  
 Dual Cool™  
 EcoSPARK®  
 EfficientMax™  
 ESBC™  
  
 Fairchild®  
 Fairchild Semiconductor®  
 FACT Quiet Series™  
 FACT®  
 FAST®  
 FastvCore™  
 FETBench™  
 FlashWriter®  
 FPS™

F-PFS™  
 FRFET®  
 Global Power Resource<sup>SM</sup>  
 Green FPS™  
 Green FPST™ e-Series™  
 Gmax™  
 GTO™  
 IntelliMAX™  
 ISOPLANAR™  
 MegaBuck™  
 MICROCOUPLER™  
 MicroFET™  
 MicroPak™  
 MicroPak2™  
 MillerDrive™  
 MotionMax™  
 Motion-SPM™  
 OptoHiT™  
 OPTOLOGIC®  
 OPTOPLANAR®  
  
 PDP SPM™

Power-SPM™  
 PowerTrench®  
 PowerXS™  
 Programmable Active Droop™  
 QFET®  
 QS™  
 Quiet Series™  
 RapidConfigure™  
  
 Saving our world, 1mW/W/kW at a time™  
 SignalWise™  
 SmartMax™  
 SMART START™  
 SPM®  
 STEALTH™  
 SuperFET™  
 SuperSOT™-3  
 SuperSOT™-6  
 SuperSOT™-8  
 SupreMOS®  
 SyncFET™  
 Sync-Lock™

 **SYSTEM GENERAL**  
 The Power Franchise®  
  
 TinyBoost™  
 TinyBuck™  
 TinyCalc™  
 TinyLogic®  
 TINYOPTO™  
 TinyPower™  
 TinyPWM™  
 TinyWire™  
 TriFault Detect™  
 TRUECURRENT™\*  
 μSerDes™  
  
 UHC®  
 Ultra FRFET™  
 UniFET™  
 VCX™  
 VisualMax™  
 XS™

\* Trademarks of System General Corporation, used under license by Fairchild Semiconductor.

**DISCLAIMER**

FAIRCHILD SEMICONDUCTOR RESERVES THE RIGHT TO MAKE CHANGES WITHOUT FURTHER NOTICE TO ANY PRODUCTS HEREIN TO IMPROVE RELIABILITY, FUNCTION, OR DESIGN. FAIRCHILD DOES NOT ASSUME ANY LIABILITY ARISING OUT OF THE APPLICATION OR USE OF ANY PRODUCT OR CIRCUIT DESCRIBED HEREIN; NEITHER DOES IT CONVEY ANY LICENSE UNDER ITS PATENT RIGHTS, NOR THE RIGHTS OF OTHERS. THESE SPECIFICATIONS DO NOT EXPAND THE TERMS OF FAIRCHILD'S WORLDWIDE TERMS AND CONDITIONS, SPECIFICALLY THE WARRANTY THEREIN, WHICH COVERS THESE PRODUCTS.

**LIFE SUPPORT POLICY**

FAIRCHILD'S PRODUCTS ARE NOT AUTHORIZED FOR USE AS CRITICAL COMPONENTS IN LIFE SUPPORT DEVICES OR SYSTEMS WITHOUT THE EXPRESS WRITTEN APPROVAL OF FAIRCHILD SEMICONDUCTOR CORPORATION.

As used herein:

1. Life support devices or systems are devices or systems which, (a) are intended for surgical implant into the body or (b) support or sustain life, and (c) whose failure to perform when properly used in accordance with instructions for use provided in the labeling, can be reasonably expected to result in a significant injury of the user.
2. A critical component in any component of a life support, device, or system whose failure to perform can be reasonably expected to cause the failure of the life support device or system, or to affect its safety or effectiveness.

**ANTI-COUNTERFEITING POLICY**

Fairchild Semiconductor Corporation's Anti-Counterfeiting Policy. Fairchild's Anti-Counterfeiting Policy is also stated on our external website, [www.fairchildsemi.com](http://www.fairchildsemi.com), under Sales Support.

Counterfeiting of semiconductor parts is a growing problem in the industry. All manufacturers of semiconductor products are experiencing counterfeiting of their parts. Customers who inadvertently purchase counterfeit parts experience many problems such as loss of brand reputation, substandard performance, failed applications, and increased cost of production and manufacturing delays. Fairchild is taking strong measures to protect ourselves and our customers from the proliferation of counterfeit parts. Fairchild strongly encourages customers to purchase Fairchild parts either directly from Fairchild or from Authorized Fairchild Distributors who are listed by country on our web page cited above. Products customers buy either from Fairchild directly or from Authorized Fairchild Distributors are genuine parts, have full traceability, meet Fairchild's quality standards for handling and storage and provide access to Fairchild's full range of up-to-date technical and product information. Fairchild and our Authorized Distributors will stand behind all warranties and will appropriately address any warranty issues that may arise. Fairchild will not provide any warranty coverage or other assistance for parts bought from Unauthorized Sources. Fairchild is committed to combat this global problem and encourage our customers to do their part in stopping this practice by buying direct or from authorized distributors.

**PRODUCT STATUS DEFINITIONS**

**Definition of Terms**

Datasheet Identification	Product Status	Definition
Advance Information	Formative / In Design	Datasheet contains the design specifications for product development. Specifications may change in any manner without notice.
Preliminary	First Production	Datasheet contains preliminary data; supplementary data will be published at a later date. Fairchild Semiconductor reserves the right to make changes at any time without notice to improve design.
No Identification Needed	Full Production	Datasheet contains final specifications. Fairchild Semiconductor reserves the right to make changes at any time without notice to improve the design.
Obsolete	Not In Production	Datasheet contains specifications on a product that is discontinued by Fairchild Semiconductor. The datasheet is for reference information only.

Rev. 149