

FAN73611

Single-Channel High-Side Gate Drive IC

Features

- Floating Channel for Bootstrap Operation to +600V
- 250mA/500mA Sourcing/Sinking Current Driving Capability
- Common-Mode dv/dt Noise-Canceling Circuit
- 3.3V and 5V Input Logic Compatible
- Output In Phase with Input Signal
- Under-Voltage Lockout for V_{DD} and V_{BS}
- 8-Lead Small Outline Package (SOP)

Applications

- High-Speed Gate Driver
- Plasma Display Panel
- Switching-Mode Power Supply (SMPS)
- Motor Drive Inverter

Description

The FAN73611 is a monolithic high-side gate drive IC that can drive MOSFETs and IGBTs operating up to +600V. Fairchild's high-voltage process and common-mode noise canceling techniques provide stable operation of the high-side driver under high dv/dt noise circumstances. An advanced level-shift circuit offers high-side gate driver operation up to $V_S = -9.8V$ (typical) for $V_{BS} = 15V$. The UVLO circuits prevents malfunction when V_{DD} or V_{BS} is lower than the specified threshold voltage. The output drivers typically source/sink 250mA/500mA; respectively, which is suitable for Plasma Display Panel (PDP) application, motor drive inverter, and switching mode power supply applications.

8-SOP



Ordering Information

Part Number	Package	Operating Temperature Range	Packing Method
FAN73611M ⁽¹⁾	8-Lead, Small-Outline Package (SOP)	-40°C ~ 125°C	Tube
FAN73611MX ⁽¹⁾			Tape & Reel

Note:

1. These devices passed wave soldering test by JESD22A-111.

Typical Application Diagrams

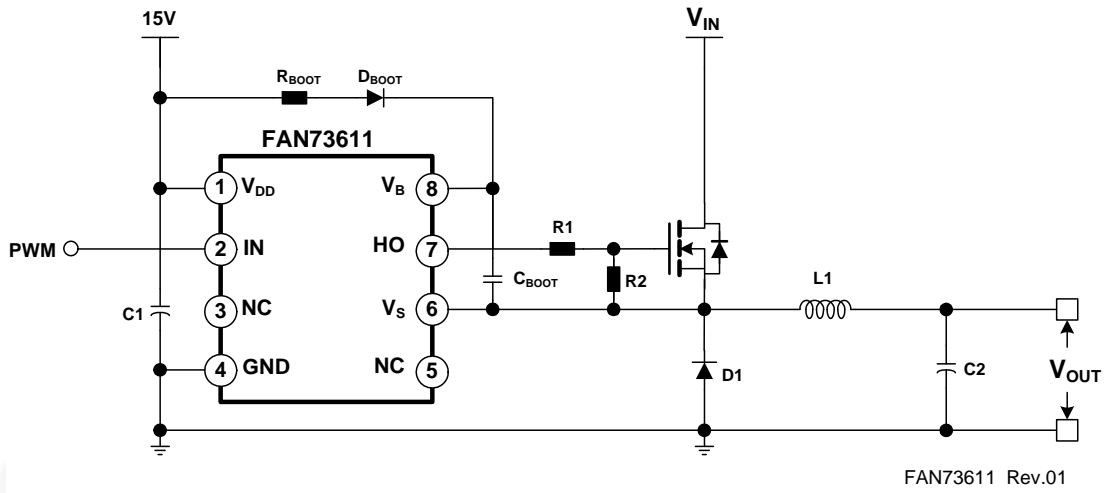

Figure 1. Step-Down (Buck) DC-DC Converter Application

Internal Block Diagram

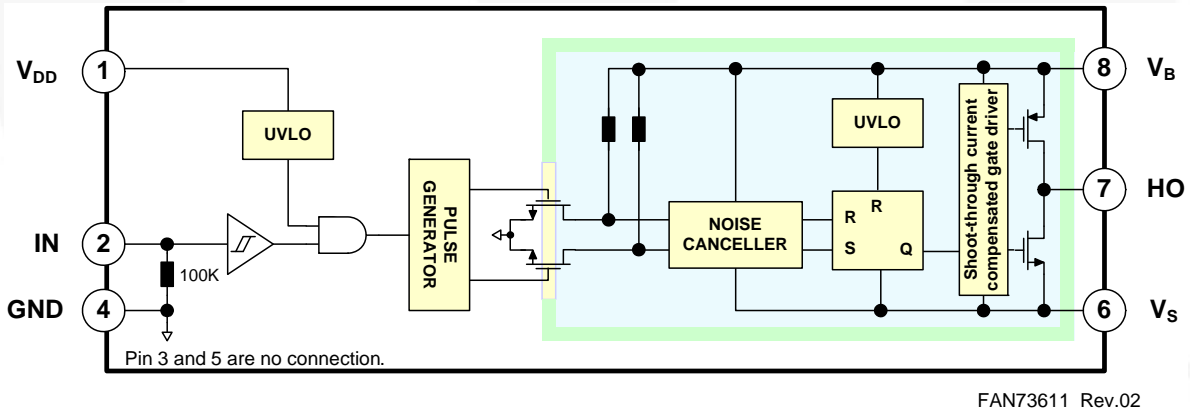

Figure 2. Functional Block Diagram

Pin Configuration

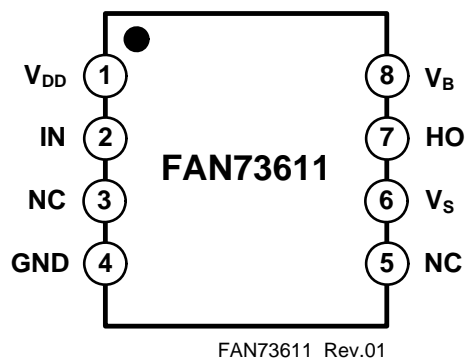

Figure 3. Pin Configuration (Top View)

Pin Definitions

Pin #	Name	Description
1	V_{DD}	Supply Voltage
2	IN	Logic Input for High-Side Gate Driver Output
3	NC	No Connection
4	GND	Ground
5	NC	No Connection
6	V_S	High-Voltage Floating Supply Return
7	HO	High-Side Driver Output
8	V_B	High-Side Floating Supply

Absolute Maximum Ratings

Stresses exceeding the absolute maximum ratings may damage the device. The device may not function or be operable above the recommended operating conditions and stressing the parts to these levels is not recommended. In addition, extended exposure to stresses above the recommended operating conditions may affect device reliability. The absolute maximum ratings are stress ratings only. $T_A=25^{\circ}\text{C}$ unless otherwise specified.

Symbol	Characteristics	Min.	Max.	Unit
V_S	High-Side Floating Offset Voltage	V_B-25	$V_B+0.3$	V
V_B	High-Side Floating Supply Voltage	-0.3	625.0	V
V_{HO}	High-Side Floating Output Voltage	$V_S-0.3$	$V_B+0.3$	V
V_{DD}	Low-Side and Logic Supply Voltage	-0.3	25.0	V
V_{IN}	Logic Input Voltage	-0.3	$V_{DD}+0.3$	V
dV_S/dt	Allowable Offset Voltage Slew Rate		± 50	V/ns
P_D	Power Dissipation ^(2, 3, 4)		0.625	W
θ_{JA}	Thermal Resistance		200	$^{\circ}\text{C}/\text{W}$
T_J	Junction Temperature	-55	+150	$^{\circ}\text{C}$
T_{STG}	Storage Temperature	-55	+150	$^{\circ}\text{C}$

Notes:

- Mounted on 76.2 x 114.3 x 1.6mm PCB (FR-4 glass epoxy material).
- Refer to the following standards:
JESD51-2: Integrated circuits thermal test method environmental conditions, natural convection, and
JESD51-3: Low effective thermal conductivity test board for leaded surface mount packages.
- Do not exceed power dissipation (P_D) under any circumstances.

Recommended Operating Conditions

The Recommended Operating Conditions table defines the conditions for actual device operation. Recommended operating conditions are specified to ensure optimal performance to the datasheet specifications. Fairchild does not recommend exceeding them or designing to absolute maximum ratings.

Symbol	Parameter	Min.	Max.	Unit
V_B	High-Side Floating Supply Voltage	V_S+10	V_S+20	V
V_S	High-Side Floating Supply Offset Voltage	$6-V_{DD}$	600	V
V_{HO}	High-Side Output Voltage	V_S	V_B	V
V_{IN}	Logic Input Voltage	GND	V_{DD}	V
V_{DD}	Supply Voltage	10	20	V
T_A	Operating Ambient Temperature	-40	+125	$^{\circ}\text{C}$

Electrical Characteristics

$V_{BIAS}(V_{DD}, V_{BS}) = 15.0V$ and $T_A = 25^\circ C$ unless otherwise specified. The V_{IN} and I_{IN} parameters are referenced to GND. The V_O and I_O parameters are relative to V_S and are applicable to the respective output HO.

Symbol	Characteristics	Test Condition	Min.	Typ.	Max.	Unit
Power Supply Section						
I_{QDD}	Quiescent V_{DD} Supply Current	$V_{IN}=0V$ or $5V$, $C_{LOAD}=1000pF$		80	140	μA
I_{PDD}	Operating V_{DD} Supply Current	$C_{LOAD}=1000pF$, $f_{IN}=20KHz$, RMS value		80	160	μA
V_{DDUV+} V_{BSUV+}	V_{DD} and V_{BS} Supply Under-Voltage Positive Going Threshold Voltage	$V_{DD}=\text{Sweep}$, $V_{BS}=\text{Sweep}$	7.8	8.8	9.8	V
V_{DDUV-} V_{BSUV-}	V_{DD} and V_{BS} Supply Under-Voltage Negative Going Threshold Voltage	$V_{DD}=\text{Sweep}$, $V_{BS}=\text{Sweep}$	7.3	8.3	9.3	V
V_{DDHYS} V_{BSHYS}	V_{DD} and V_{BS} Supply Under-Voltage Lockout Hysteresis Voltage	$V_{DD}=\text{Sweep}$, $V_{BS}=\text{Sweep}$		0.5		V
I_{LK}	Offset Supply Leakage Current	$V_B=V_S=600V$			10	μA
I_{QBS}	Quiescent V_{BS} Supply Current	$V_{IN}=0V$ or $5V$, $C_{LOAD}=1000pF$		60	100	μA
I_{PBS}	Operating V_{BS} Supply Current	$C_{LOAD}=1000pF$, $f_{IN}=20KHz$, RMS Value		420	600	μA
Input Logic Section						
V_{IH}	Logic "1" Input Voltage		2.5			V
V_{IL}	Logic "0" Input Voltage				0.8	V
I_{IN+}	Logic Input High Bias Current	$V_{IN}=5V$		50	75	μA
I_{IN-}	Logic Input Low Bias Current	$V_{IN}=0V$			2	μA
R_{IN}	Input Pull-Down Resistance		60	100		$K\Omega$
Gate Driver Output Section						
V_{OH}	High Level Output Voltage ($V_{BIAS} - V_O$)	No Load			0.1	V
V_{OL}	Low Level Output Voltage	No Load			0.1	V
I_{O+}	Output High, Short-Circuit Pulsed Current	$V_{HO}=0V$, $V_{IN}=5V$, $PW \leq 10\mu s$	200	250		mA
I_{O-}	Output Low, Short-Circuit Pulsed Current	$V_{HO}=15V$, $V_{IN}=0V$, $PW \leq 10\mu s$	400	500		mA
V_S	Allowable Negative V_S Pin Voltage for IN Signal Propagation to HO	$V_{BS}=15V$		-9.8	-7.0	V

Dynamic Electrical Characteristics

$V_{DD}=V_{BS}=15V$, $C_{LOAD}=1000pF$, and $T_A=25^\circ C$, unless otherwise specified.

Symbol	Parameter	Conditions	Min.	Typ.	Max.	Unit
t_{on}	Turn-On Propagation Delay Time	$V_S=0V$	70	120	170	ns
t_{off}	Turn-Off Propagation Delay Time	$V_S=0V$	70	120	170	ns
t_r	Turn-On Rise Time			70	140	ns
t_f	Turn-Off Fall Time			30	60	ns

Typical Characteristics

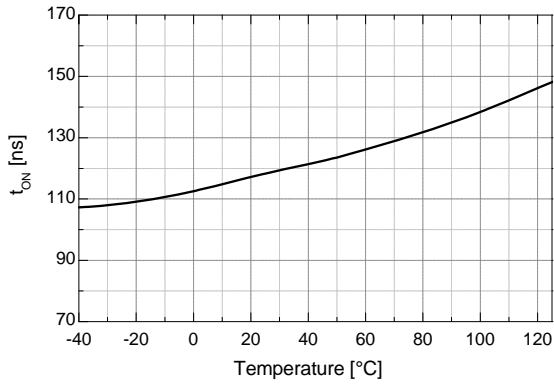

Figure 5. Turn-On Propagation Delay vs. Temperature

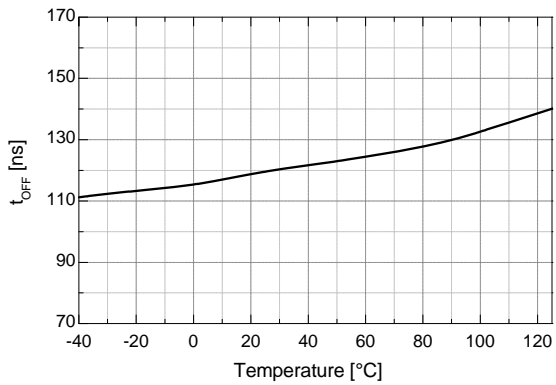

Figure 6. Turn-Off Propagation Delay vs. Temperature

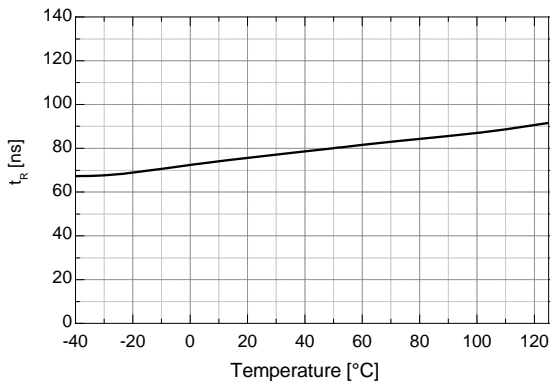

Figure 7. Turn-On Rise Time vs. Temperature

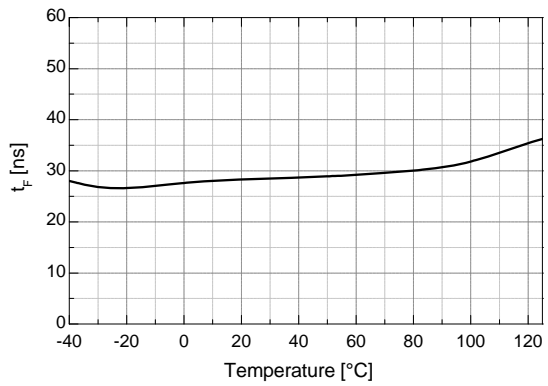

Figure 8. Turn-Off Fall Time vs. Temperature

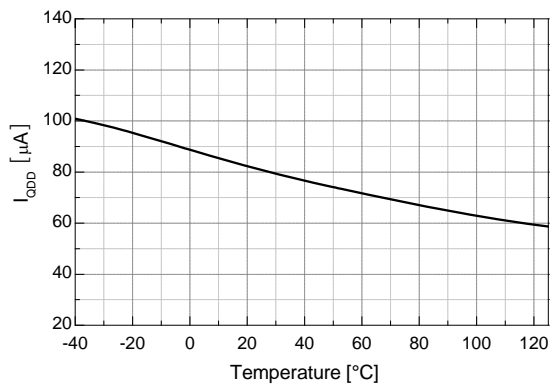

Figure 9. Quiescent V_{DD} Supply Current vs. Temperature

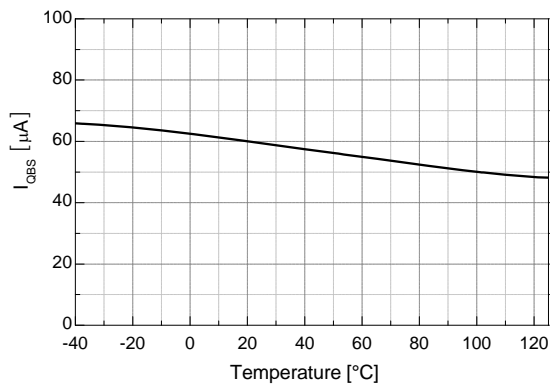

Figure 10. Quiescent V_{BS} Supply Current vs. Temperature

Typical Characteristics (Continued)

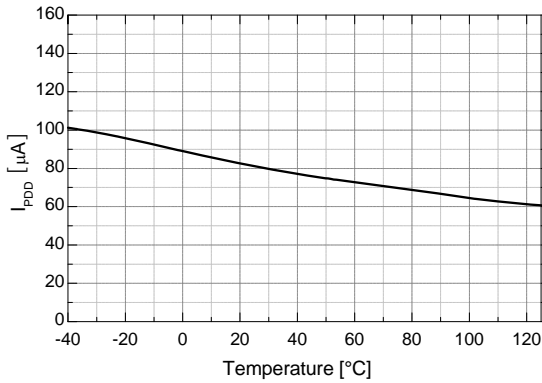

Figure 11. Operating V_{DD} Supply Current vs. Temperature

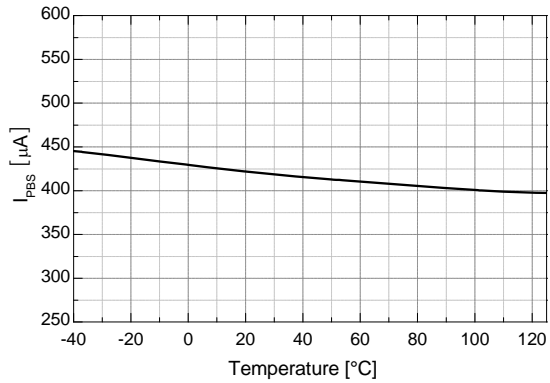

Figure 12. Operating V_{BS} Supply Current vs. Temperature

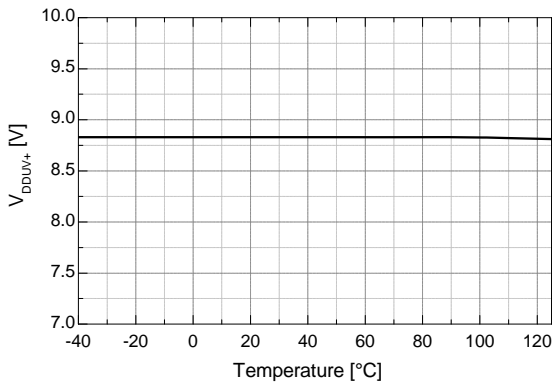

Figure 13. V_{DD} UVLO+ vs. Temperature

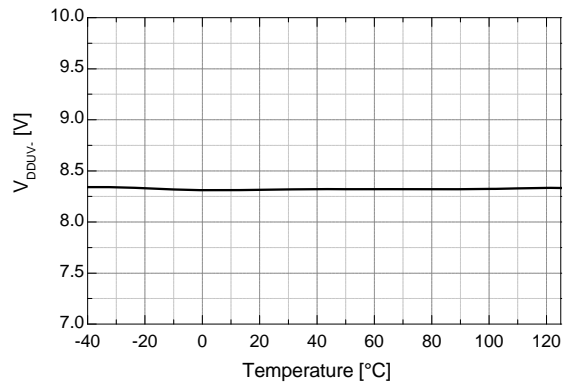

Figure 14. V_{DD} UVLO- vs. Temperature

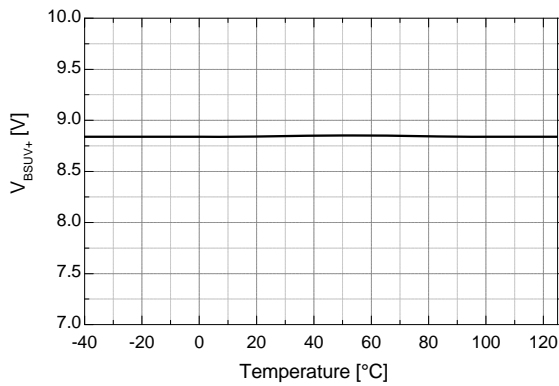

Figure 15. V_{BS} UVLO+ vs. Temperature

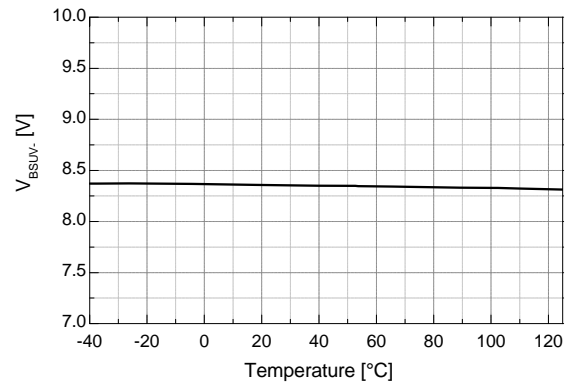

Figure 16. V_{BS} UVLO- vs. Temperature

Typical Characteristics (Continued)

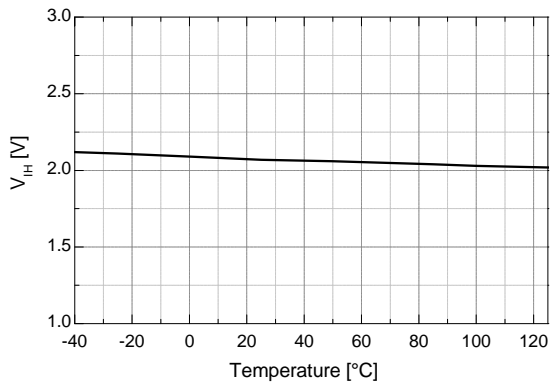

Figure 17. Logic HIGH Input Voltage vs. Temperature

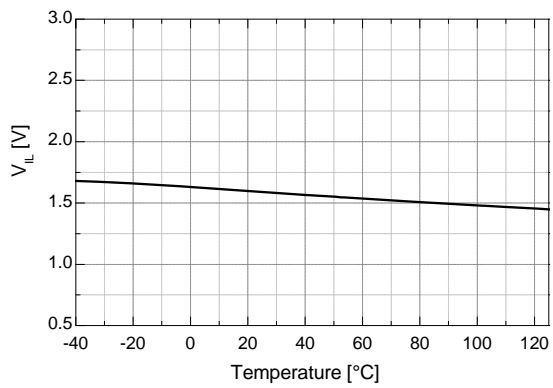

Figure 18. Logic LOW Input Voltage vs. Temperature

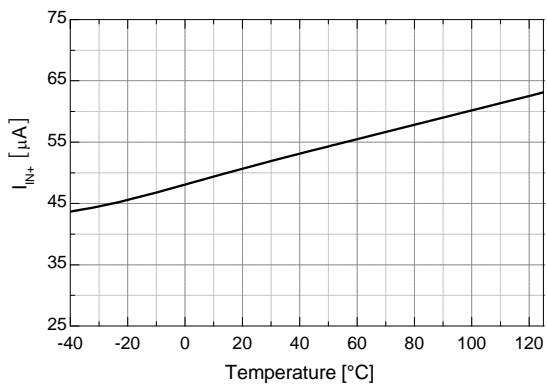

Figure 19. Logic HIGH Input Bias Current vs. Temperature

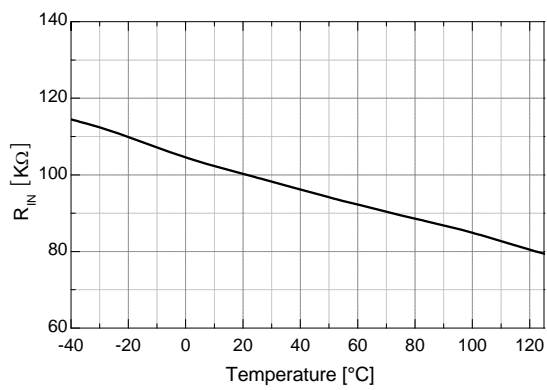

Figure 20. Input Pull-Down Resistance vs. Temperature

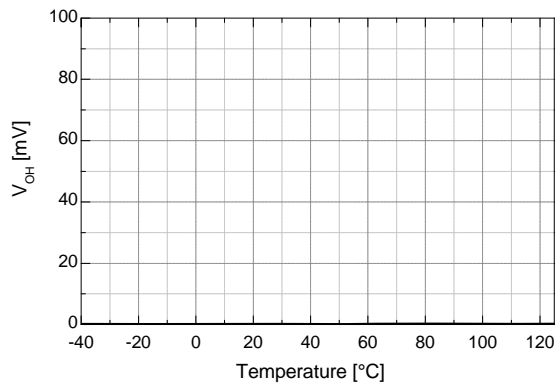

Figure 21. High-Level Output Voltage vs. Temperature

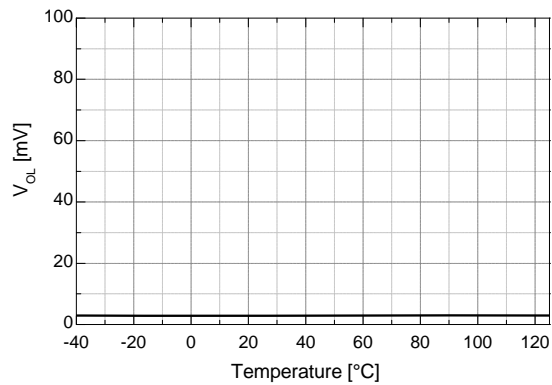

Figure 22. Low-Level Output Voltage vs. Temperature

Typical Characteristics (Continued)

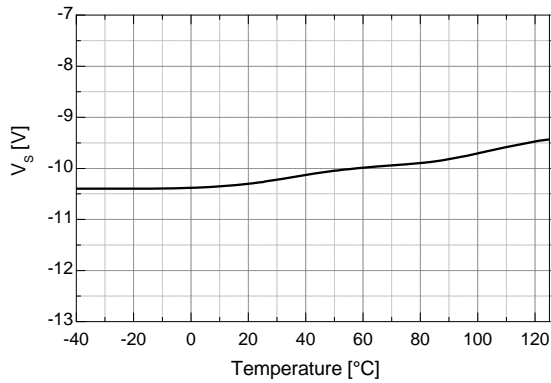

Figure 23. Allowable Negative V_S Voltage vs. Temperature

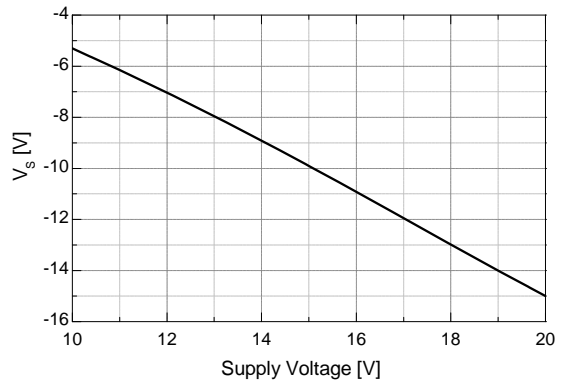

Figure 24. Allowable Negative V_S Voltage vs. Supply Voltage

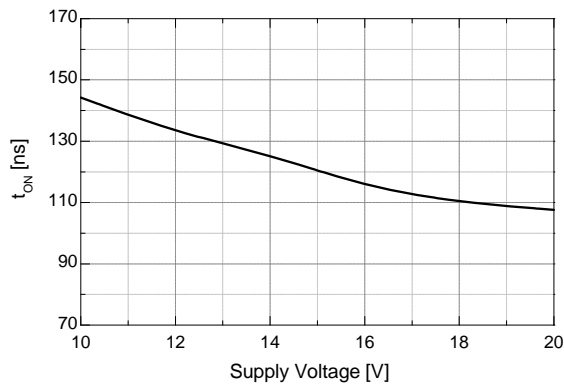

Figure 25. Turn-On Propagation Delay vs. Supply Voltage

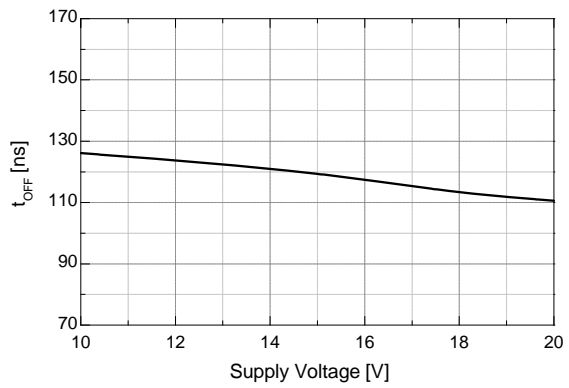

Figure 26. Turn-Off Propagation Delay vs. Supply Voltage

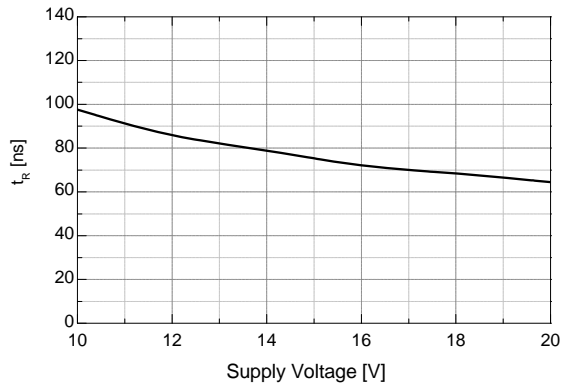

Figure 27. Turn-On Rise Time vs. Supply Voltage

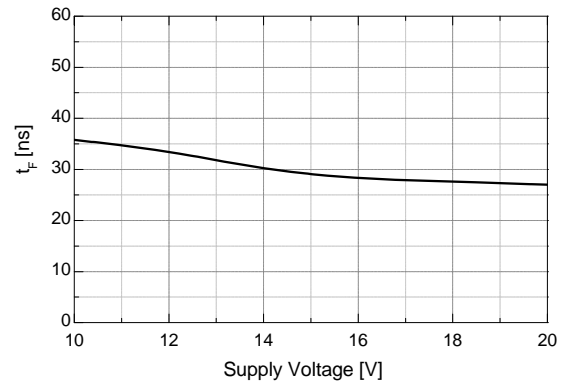

Figure 28. Turn-Off Fall Time vs. Supply Voltage

Typical Characteristics (Continued)

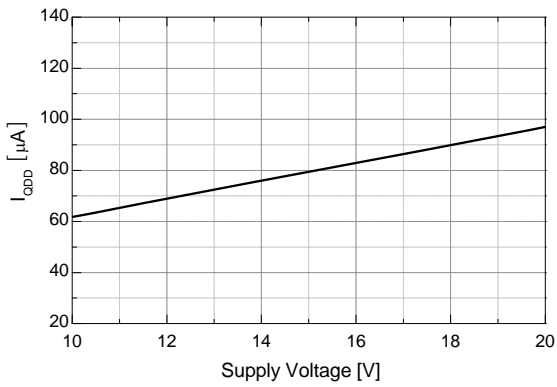

Figure 29. Quiescent V_{DD} Supply Current vs. Supply Voltage

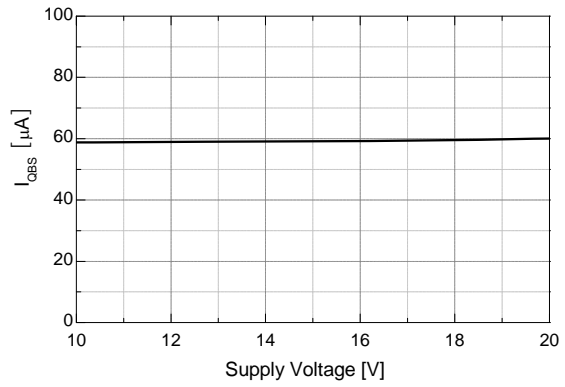

Figure 30. Quiescent V_{BS} Supply Current vs. Supply Voltage

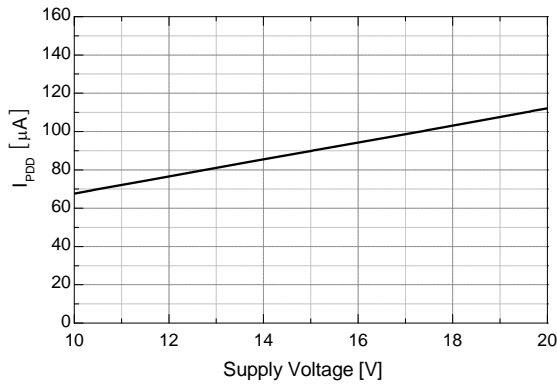

Figure 31. Operating V_{DD} Supply Current vs. Supply Voltage

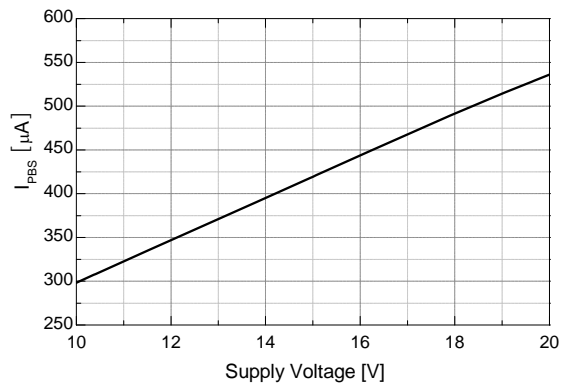

Figure 32. Operating V_{BS} Supply Current vs. Supply Voltage

Switching Time Definitions

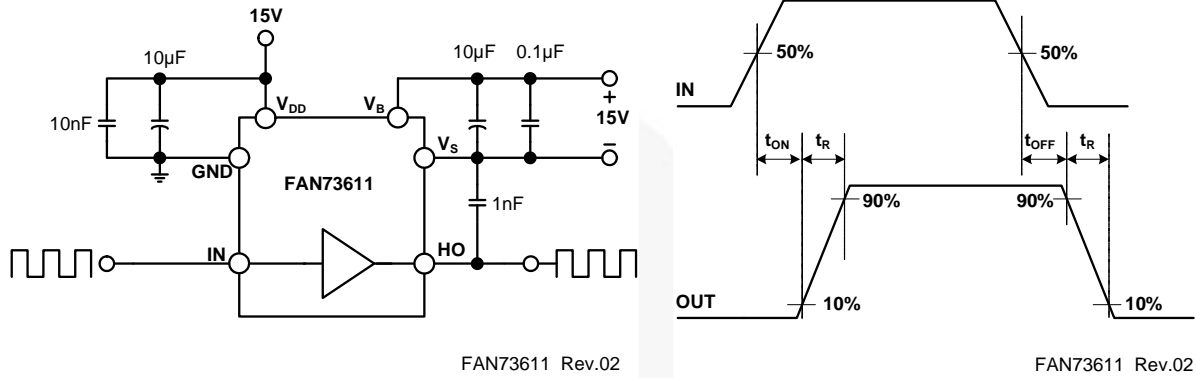

Figure 33. Switching Time Test Circuit and Waveform Definitions

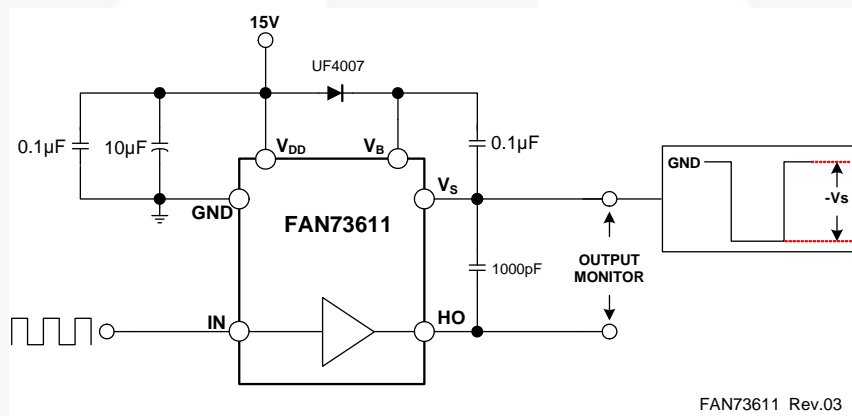

Figure 34. Floating Supply Voltage Transient Test

Physical Dimensions

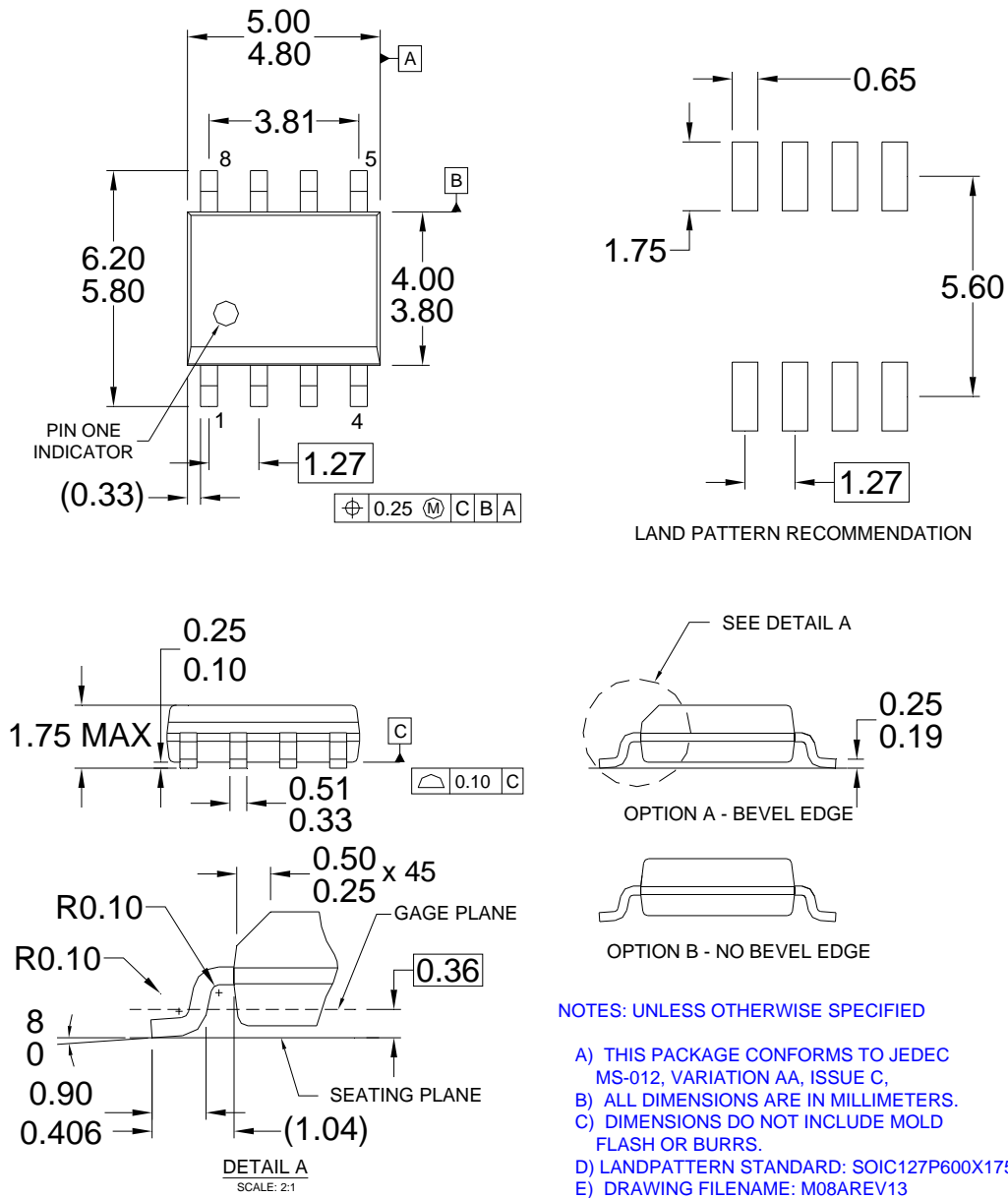

Figure 35. 8-Lead, Small Outline Package (SOP)

Package drawings are provided as a service to customers considering Fairchild components. Drawings may change in any manner without notice. Please note the revision and/or date on the drawing and contact a Fairchild Semiconductor representative to verify or obtain the most recent revision. Package specifications do not expand the terms of Fairchild's worldwide terms and conditions, specifically the warranty therein, which covers Fairchild products.

Always visit Fairchild Semiconductor's online packaging area for the most recent package drawings:
<http://www.fairchildsemi.com/packaging/>.



TRADEMARKS

The following includes registered and unregistered trademarks and service marks, owned by Fairchild Semiconductor and/or its global subsidiaries, and is not intended to be an exhaustive list of all such trademarks.

- | | | | |
|--------------------------|-------------------------------------|---------------------------------------|---|
| AccuPower™ | F-PFS™ | Power-SPM™ | <p>SYSTEM GENERAL
The Power Franchise®
the power franchise
TinyBoost™
QST™
TinyBuck™
TinyCalc™
TinyLogic®
TINYOPTO™
TinyPower™
TinyPWM™
TinyWire™
TriFault Detect™
TRUECURRENT™*
µSerDes™
 SerDes™
UHC®
Ultra FRFET™
UniFET™
VCX™
VisualMax™
XS™</p> |
| Auto-SPM™ | FRFET® | PowerTrench® | |
| Build it Now™ | Global Power Resource SM | PowerXS™ | |
| CorePLUSTM | Green FPS™ | Programmable Active Droop™ | |
| CorePOWER™ | Green FPS™ e-Series™ | QFET® | |
| CROSSVOLT™ | Gmax™ | QST™ | |
| CTL™ | GTO™ | Quiet Series™ | |
| Current Transfer Logic™ | IntelliMAX™ | RapidConfigure™ | |
| DEUXPEED® | ISOPLANAR™ | ™ | |
| Dual Cool™ | MegaBuck™ | Saving our world, 1mW/W/kW at a time™ | |
| EcoSPARK® | MICROCOUPLER™ | SignalWise™ | |
| EfficientMax™ | MicroFET™ | SmartMax™ | |
| ESBC™ | MicroPak™ | SMART START™ | |
| Fairchild® | MicroPak2™ | SPM® | |
| Fairchild Semiconductor® | MillerDrive™ | STEALTH™ | |
| FACT Quiet Series™ | MotionMax™ | SuperFET™ | |
| FACT® | Motion-SPM™ | SuperSOT™.3 | |
| FAST® | OptoHIT™ | SuperSOT™.8 | |
| FastvCore™ | OPTOLOGIC® | SuperSOT™.8 | |
| FETBench™ | OPTOPLANAR® | SupreMOS® | |
| FlashWriter® | PDP SPM™ | SyncFET™ | |
| FPS™ | | Sync-Lock™ | |

* Trademarks of System General Corporation, used under license by Fairchild Semiconductor.

DISCLAIMER

FAIRCHILD SEMICONDUCTOR RESERVES THE RIGHT TO MAKE CHANGES WITHOUT FURTHER NOTICE TO ANY PRODUCTS HEREIN TO IMPROVE RELIABILITY, FUNCTION, OR DESIGN. FAIRCHILD DOES NOT ASSUME ANY LIABILITY ARISING OUT OF THE APPLICATION OR USE OF ANY PRODUCT OR CIRCUIT DESCRIBED HEREIN; NEITHER DOES IT CONVEY ANY LICENSE UNDER ITS PATENT RIGHTS, NOR THE RIGHTS OF OTHERS. THESE SPECIFICATIONS DO NOT EXPAND THE TERMS OF FAIRCHILD'S WORLDWIDE TERMS AND CONDITIONS, SPECIFICALLY THE WARRANTY THEREIN, WHICH COVERS THESE PRODUCTS.

LIFE SUPPORT POLICY

FAIRCHILD'S PRODUCTS ARE NOT AUTHORIZED FOR USE AS CRITICAL COMPONENTS IN LIFE SUPPORT DEVICES OR SYSTEMS WITHOUT THE EXPRESS WRITTEN APPROVAL OF FAIRCHILD SEMICONDUCTOR CORPORATION.

As used herein:

1. Life support devices or systems are devices or systems which, (a) are intended for surgical implant into the body or (b) support or sustain life, and (c) whose failure to perform when properly used in accordance with instructions for use provided in the labeling, can be reasonably expected to result in a significant injury of the user.
2. A critical component in any component of a life support, device, or system whose failure to perform can be reasonably expected to cause the failure of the life support device or system, or to affect its safety or effectiveness.

ANTI-COUNTERFEITING POLICY

Fairchild Semiconductor Corporation's Anti-Counterfeiting Policy. Fairchild's Anti-Counterfeiting Policy is also stated on our external website, www.fairchildsemi.com, under Sales Support.

Counterfeiting of semiconductor parts is a growing problem in the industry. All manufacturers of semiconductor products are experiencing counterfeiting of their parts. Customers who inadvertently purchase counterfeit parts experience many problems such as loss of brand reputation, substandard performance, failed applications, and increased cost of production and manufacturing delays. Fairchild is taking strong measures to protect ourselves and our customers from the proliferation of counterfeit parts. Fairchild strongly encourages customers to purchase Fairchild parts either directly from Fairchild or from Authorized Fairchild Distributors who are listed by country on our web page cited above. Products customers buy either from Fairchild directly or from Authorized Fairchild Distributors are genuine parts, have full traceability, meet Fairchild's quality standards for handling and storage and provide access to Fairchild's full range of up-to-date technical and product information. Fairchild and our Authorized Distributors will stand behind all warranties and will appropriately address any warranty issues that may arise. Fairchild will not provide any warranty coverage or other assistance for parts bought from Unauthorized Sources. Fairchild is committed to combat this global problem and encourage our customers to do their part in stopping this practice by buying direct or from authorized distributors.

PRODUCT STATUS DEFINITIONS

Definition of Terms

Datasheet Identification	Product Status	Definition
Advance Information	Formative / In Design	Datasheet contains the design specifications for product development. Specifications may change in any manner without notice.
Preliminary	First Production	Datasheet contains preliminary data; supplementary data will be published at a later date. Fairchild Semiconductor reserves the right to make changes at any time without notice to improve design.
No Identification Needed	Full Production	Datasheet contains final specifications. Fairchild Semiconductor reserves the right to make changes at any time without notice to improve the design.
Obsolete	Not In Production	Datasheet contains specifications on a product that is discontinued by Fairchild Semiconductor. The datasheet is for reference information only.

Rev. 149