

ASSP Mobile Communication Systems

SAW Duplexer (700 to 1000 MHz)

D5CC Series (D1)

■ DESCRIPTION

The D5CC series of SAW antenna duplexer apply to the frequency range 700 to 1000 MHz.

The SAW filters are fabricated on a piezoelectric-crystal unit (LiTaO₃:lithium tantalate) with a large electromechanical dissociation.

The D5CC series provides small size and light duplexer by using original design, mounting and electrode formation techniques.

D5CC(D1) series are incorporated transmitter filter and receiver filter into a small package and are housed phase circuit in the package. Moreover, I/O of SAW filter is set to impedance 50 Ω, so application requires no external circuits.

■ FEATURES

- Ultra compact and light package (0.14cm³, 9.5 × 7.5 × 2.0 (h) mm Typ.)
- External matching circuits are not required.
- Surface mount package (SMT)
- High handling power resistance (1.2 W Max.)

■ PACKAGE

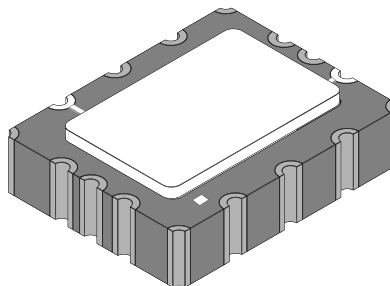

D5CC Series (D1)

■ PIN ASSIGNMENT

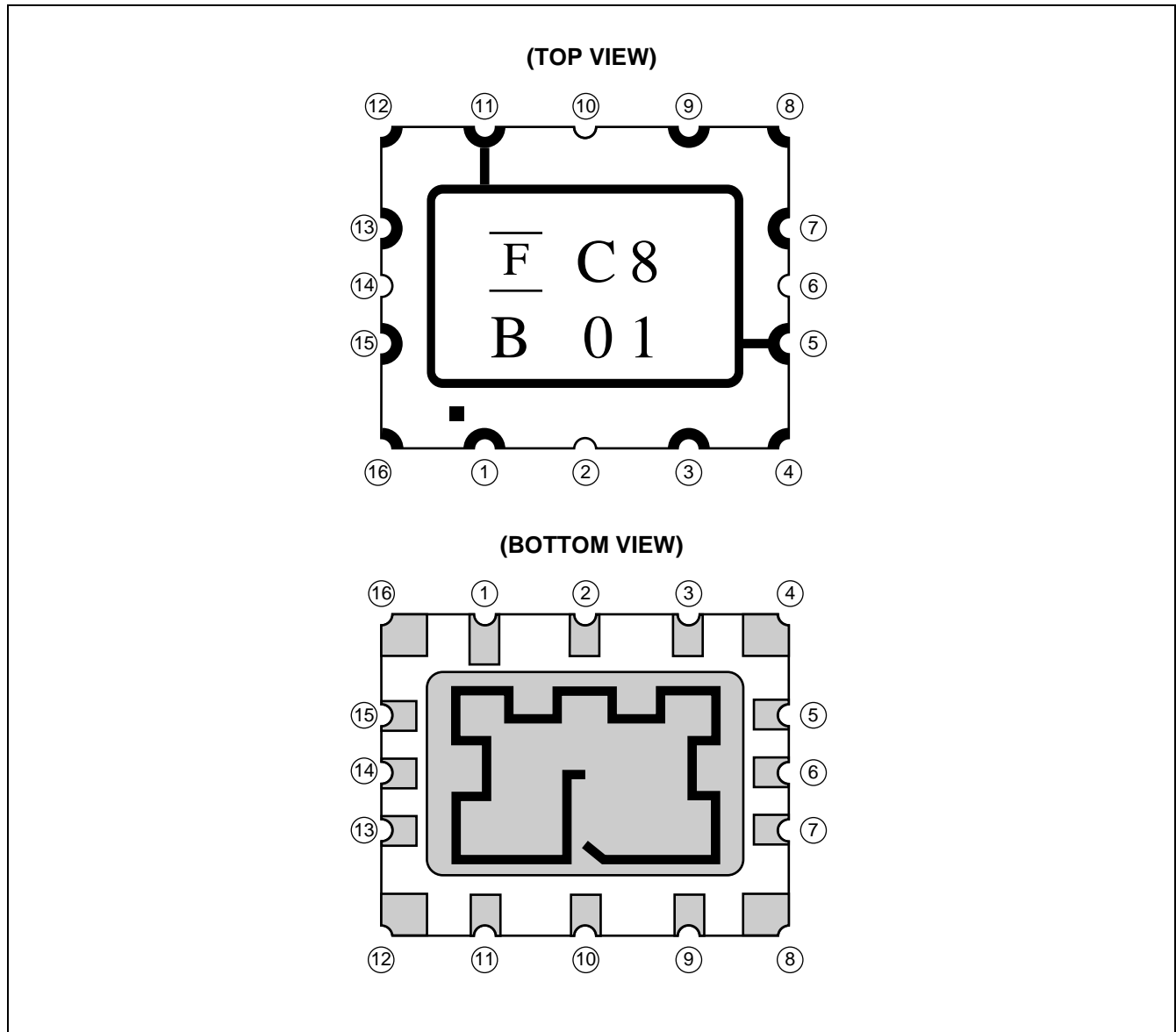

■ PIN DESCRIPTION

Pin No.	Pin name	Description
1	GND	Ground Pin
2	ANT	Antenna Pin*
3	GND	Ground Pin
4	GND	Ground Pin
5	GND	Ground Pin
6	Rx	Receiver side Pin
7	GND	Ground Pin
8	GND	Ground Pin
9	GND	Ground Pin
10	ANT	Antenna Pin*
11	GND	Ground Pin
12	GND	Ground Pin
13	GND	Ground Pin
14	Tx	Transmitter side Pin
15	GND	Ground Pin
16	GND	Ground Pin

* : Only one Antenna pin should be connected.
The remaining Antenna pin doesnot have to be connected.

D5CC Series (D1)

■ ABSOLUTE MAXIMUM RATINGS

Parameter	Symbol	Rating		Unit
		Min.	Max.	
Operating temperature	Ta	-30	+85	°C
Storage temperature	Tstg	-40	+100	°C
Maximum input power	P _{IN}	—	1.2	W
Input DC voltage	—	-5	+5	V

WARNING: Piezoelectric devices can be permanently damaged by application of stress (voltage, current, temperature, etc.) in excess of absolute maximum ratings. Do not exceed these ratings.

■ RECOMMENDED OPERATING CONDITIONS

Parameter	Symbol	Value		Unit
		Min.	Max.	
Operating temperature	Ta	-30	+85	°C

WARNING: The recommended operating conditions are required in order to ensure the normal operation of the piezoelectric device. All of the device's electrical characteristics are warranted when the device is operated within these ranges.

Always use piezoelectric devices within their recommended operating condition ranges. Operation outside these ranges may adversely affect reliability and could result in device failure.

No warranty is made with respect to uses, operating conditions, or combinations not represented on the data sheet. Users considering application outside the listed conditions are advised to contact their FUJITSU representatives beforehand.

■ STANDARD FREQUENCIES

System	Tx freq. (MHz)	Rx freq. (MHz)	Part number	Part symbol	Remarks
AMPS/IS-95/IS-136	824 to 849	869 to 894	FAR-D5CC-881M50-D1C8	C8	

D5CC Series (D1)

■ ELECTRICAL CHARACTERISTICS

AMPS/IS-136/IS-95

1. Part number : FAR-D5CC-881M50-D1C8

(Ta = -30 °C to +85 °C)

Parameter		Condition	Value			Unit	Remarks	
			Min.	Typ.	Max.			
Tx → Antenna	Insertion Loss	824 to 849 MHz	—	2.0	2.5	dB	+15 to +35 °C	
			—	—	2.7		-30 to +85 °C	
	Inband Ripple	824 to 849 MHz	—	1.0	1.5	dB		
	VSWR (Return loss)	842 to 849 MHz	— (7.4)	1.8 (10.9)	2.5 (—)		— (dB)	
	Absolute Attenuation		779 to 804 MHz	12	17	—	dB	
			869 to 894 MHz	40	46	—		
			1648 to 1698 MHz	6	9	—		
2472 to 2547 MHz			6	8	—			
Antenna → Rx	Insertion Loss	869 to 894 MHz	—	3.8	4.3	dB		
	Inband Ripple	869 to 894 MHz	—	1.5	2.5			
	VSWR (Return loss)	869 to 894 MHz	— (6.8)	2.3 (8.1)	2.7 (—)	— (dB)		
	Absolute Attenuation		824 to 849 MHz	50	55	—	dB	
			930 to 1200 MHz	40	43	—		
			1200 to 1500 MHz	40	43	—		
			1500 to 1800MHz	40	45	—		
Tx → Rx	Absolute Attenuation (Isolation)	824 to 849 MHz	53	55	—	dB		
		869 to 894 MHz	46	49	—		+15 to +85 °C	
			43	—	—		-30 to +15 °C	
Maximum Input Power		Ta = +50 °C	1.2 W (continuous wave > 50000 h)					

D5CC Series (D1)

• Typical Characteristics

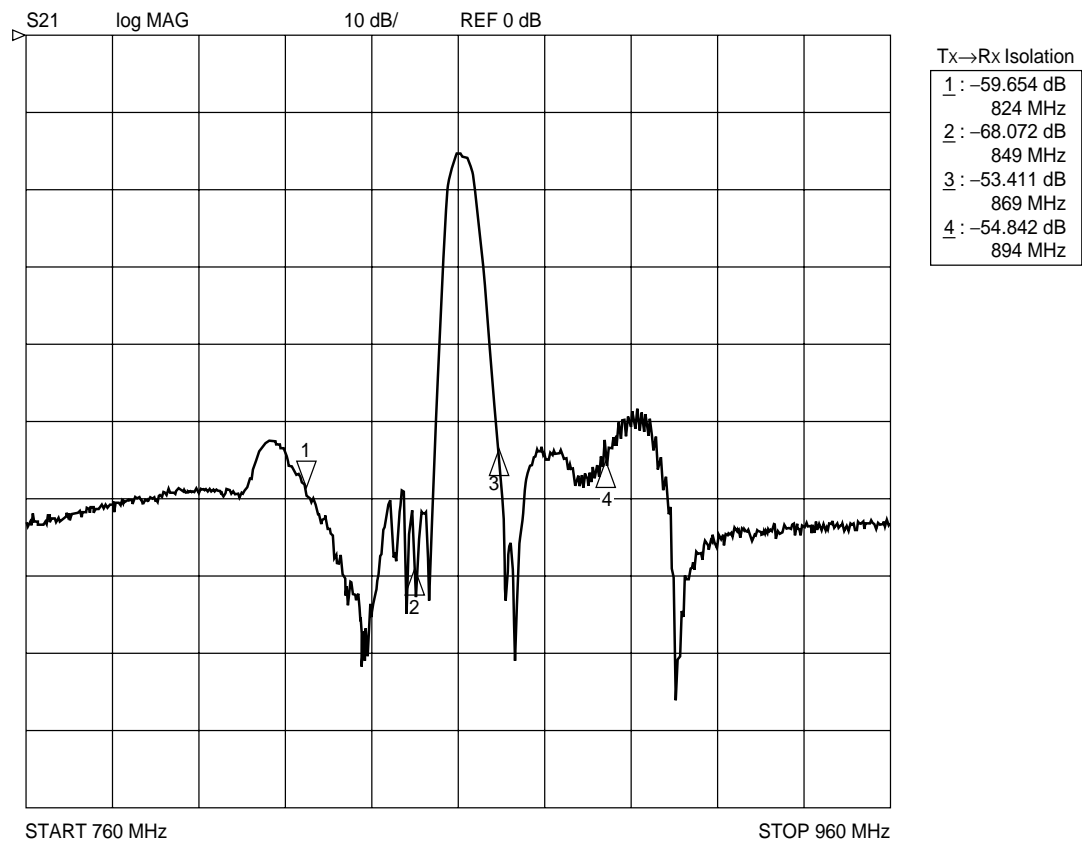
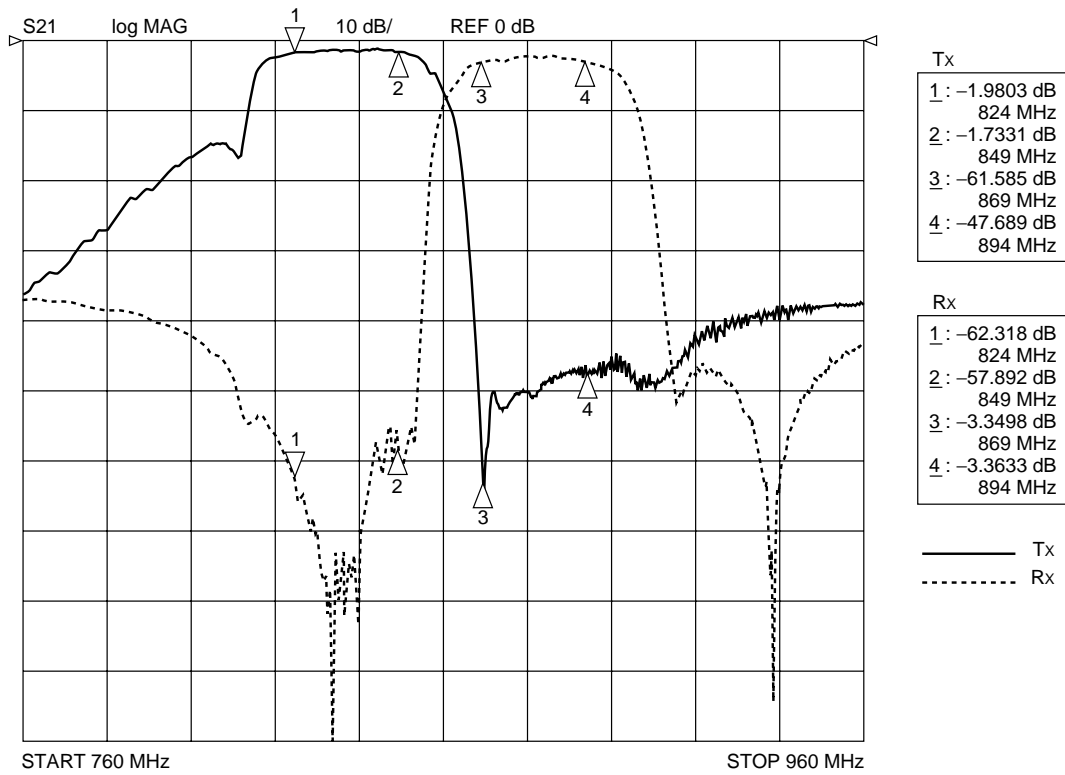

D5CC Series (D1)

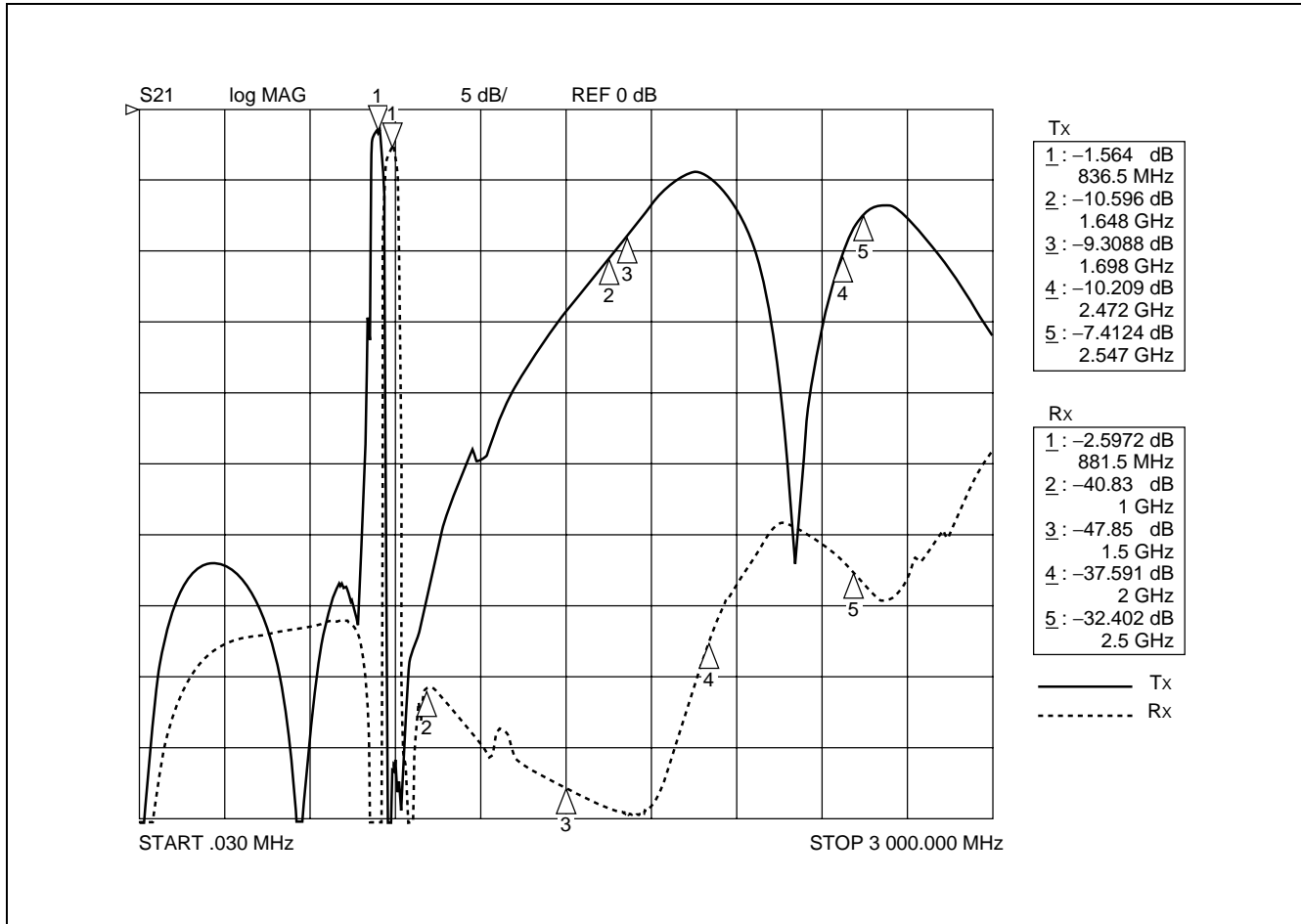

D5CC Series (D1)

MEASUREMENT CIRCUIT

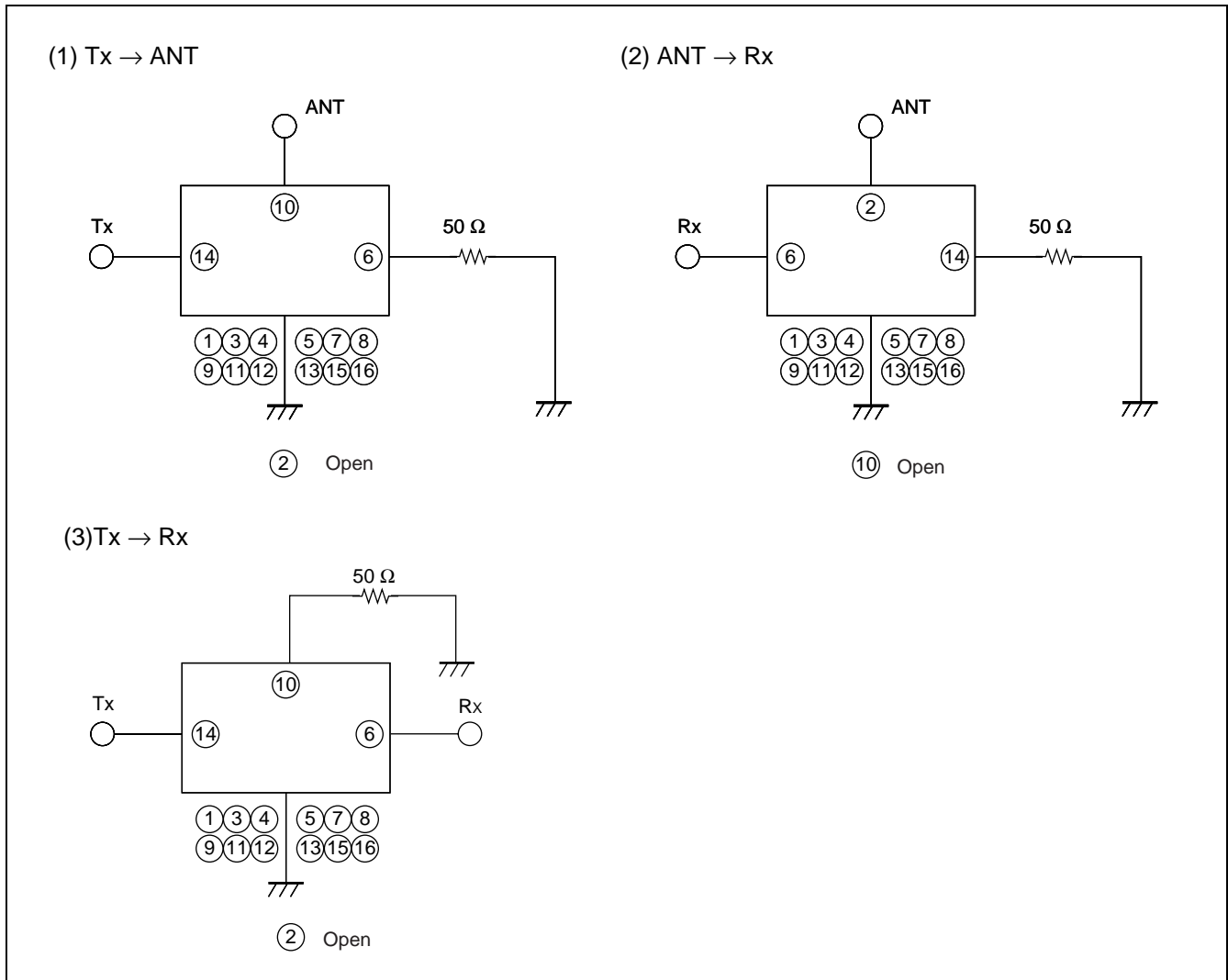

PART NUMBER DESIGNATION

[Designation example]

FAR-D5CC- □□□□□□ -D1 □□ - □
 (1) (2) (3)

(1) Frequency : Specify the nominal center frequency of higher frequency side in six alphanumeric.
 Enter M (for MHz) at the decimal point. Refer to below example.

[Example] 881.5 MHz → 881M50

(2) Part symbol : Specified characters from A1 to Z9.

(3) Packing : T : 1 k pcs/reel

Q : 2 k pcs/reel

■ MARKING

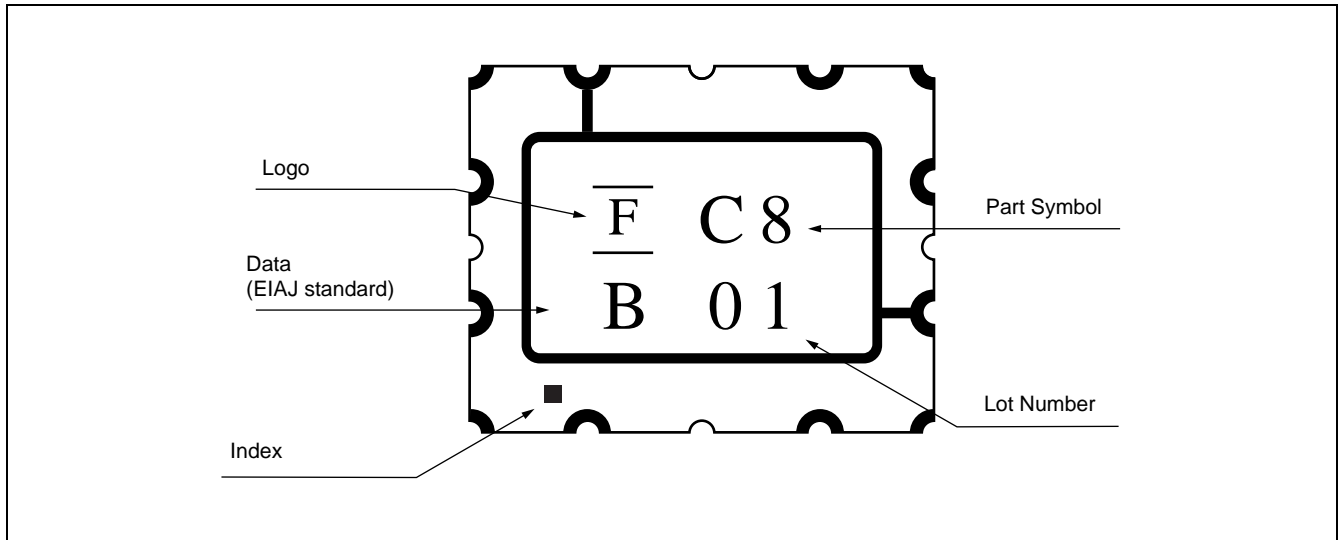

D5CC Series (D1)

■ PACKAGE DIMENSION

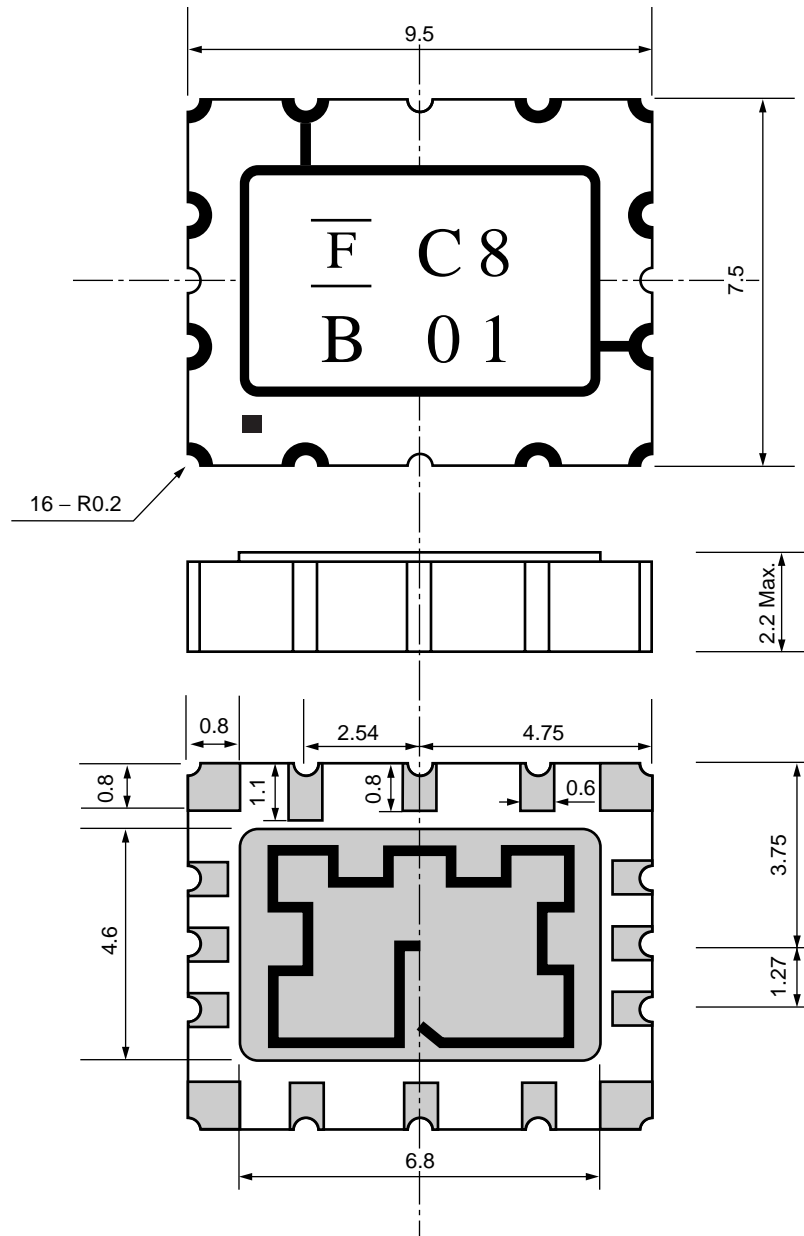

Dimensions in mm.

RECOMMENDED LAND PATTERN

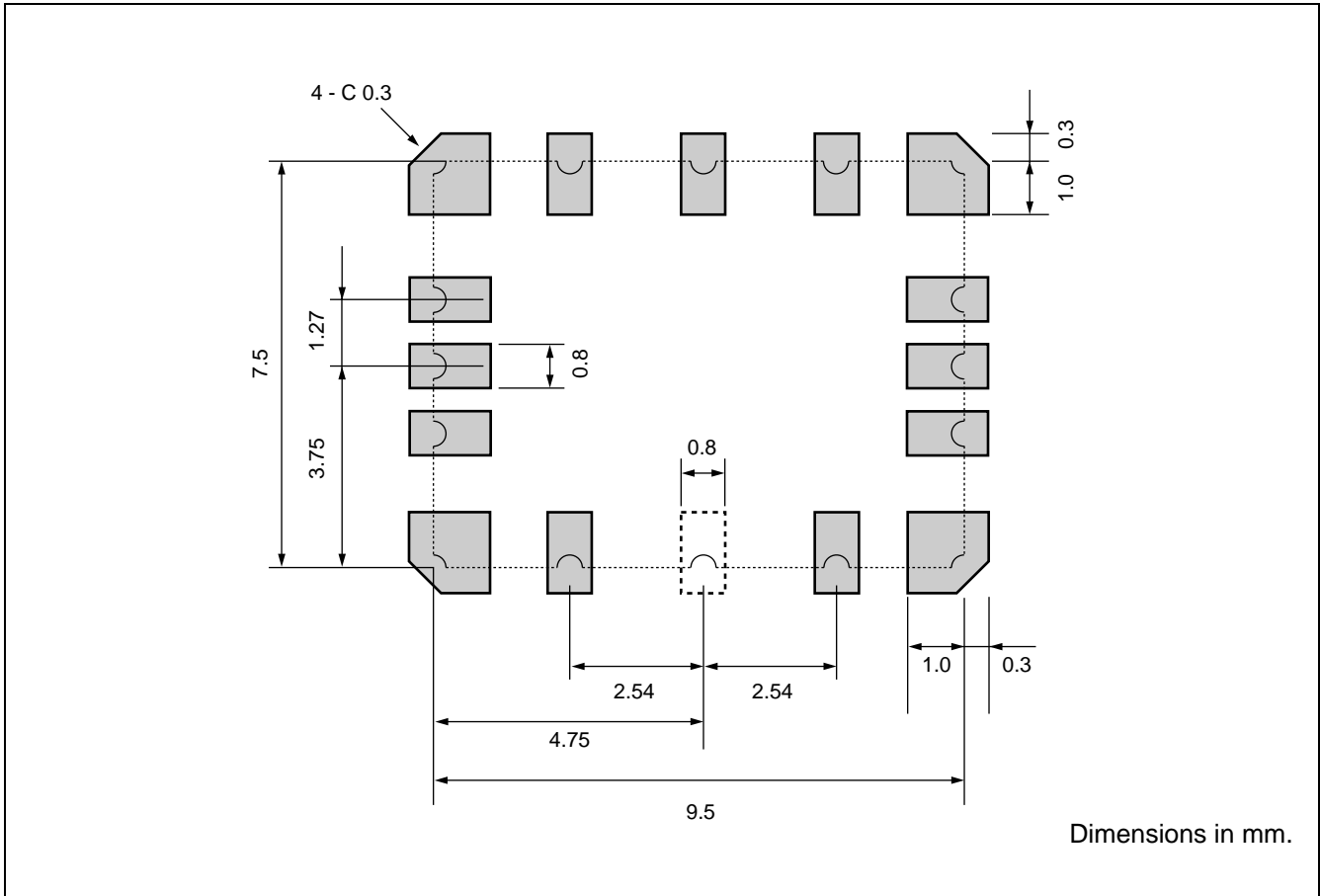

Note : Only one Antenna pin should be connected.
The remaining Antenna pin does not have to be connected.

D5CC Series (D1)

■ PACKING : Reel type

(1) Reel Dimensions

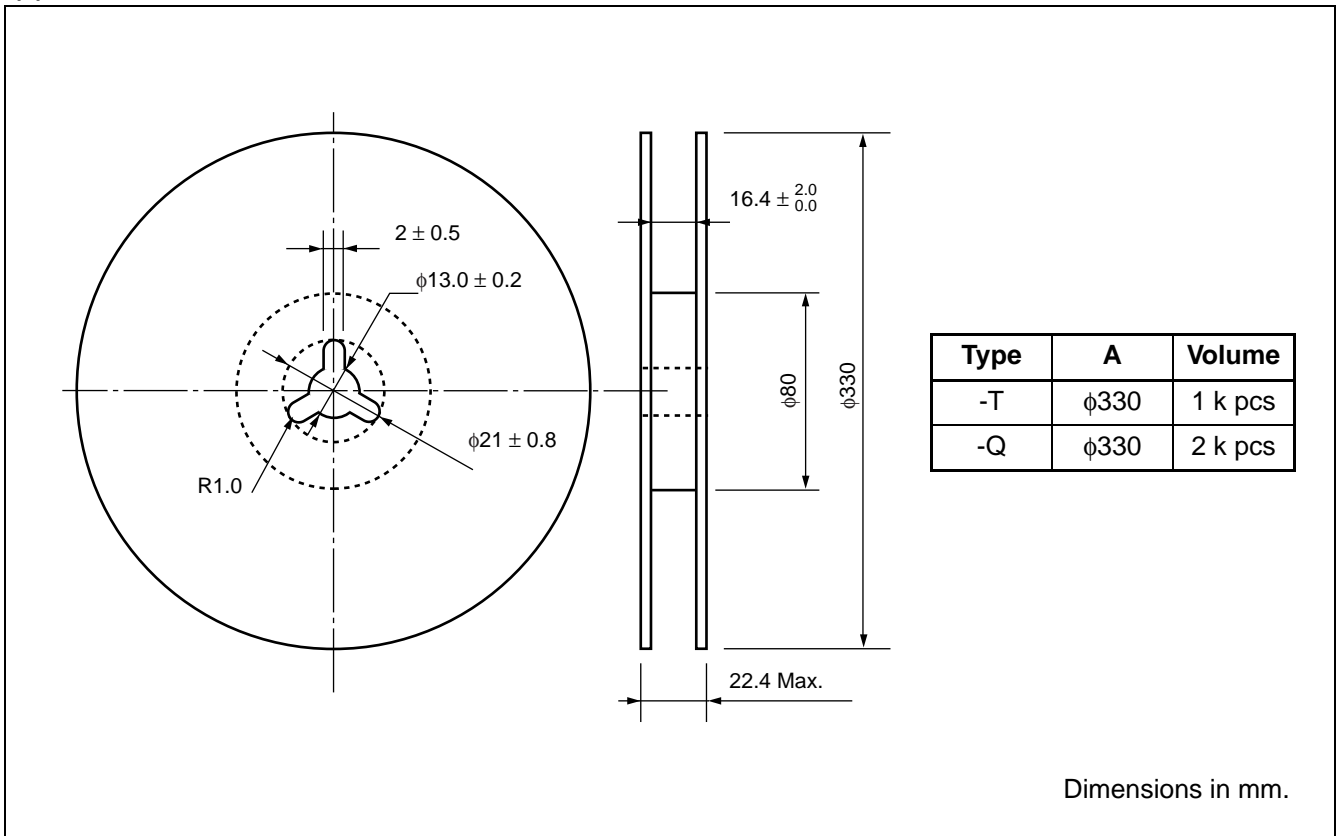

(2) Packing Style

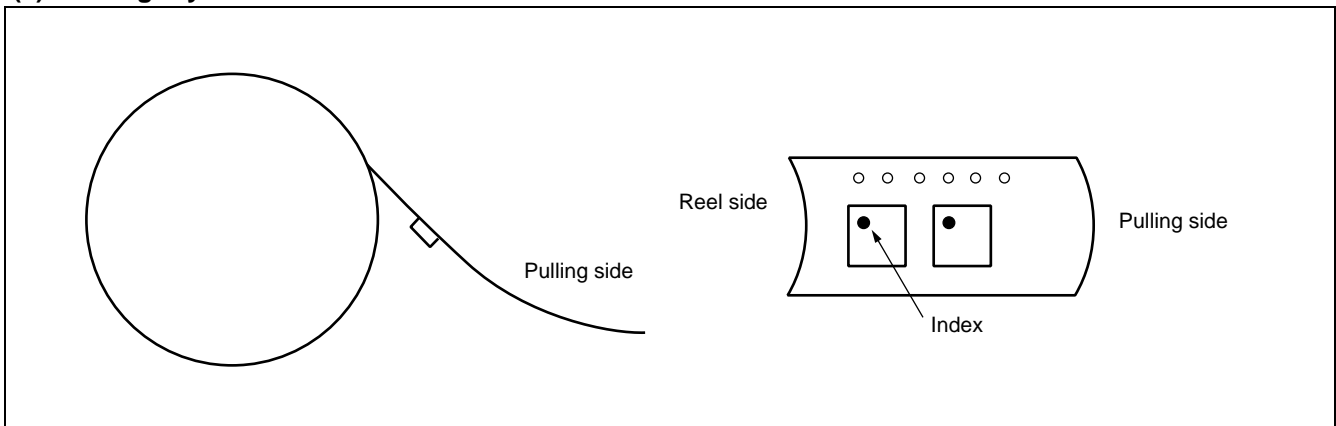

(3) Tape Dimensions

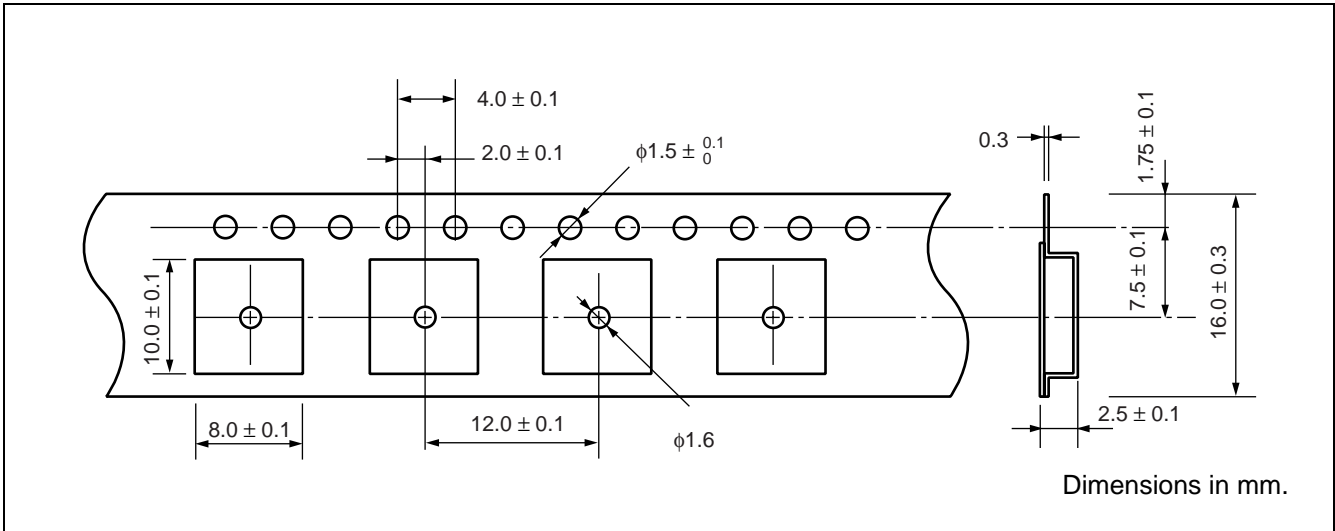

(4) Peel strength of top cover tape

Peel off by the force of 0.1 N to 0.7 N
under the condition at the right.
(Conforms to JIS C 0806 section 5.2)

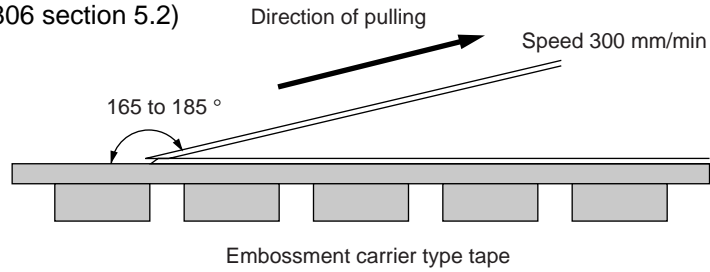

D5CC Series (D1)

RECOMMENDED REFLOW PROFILE

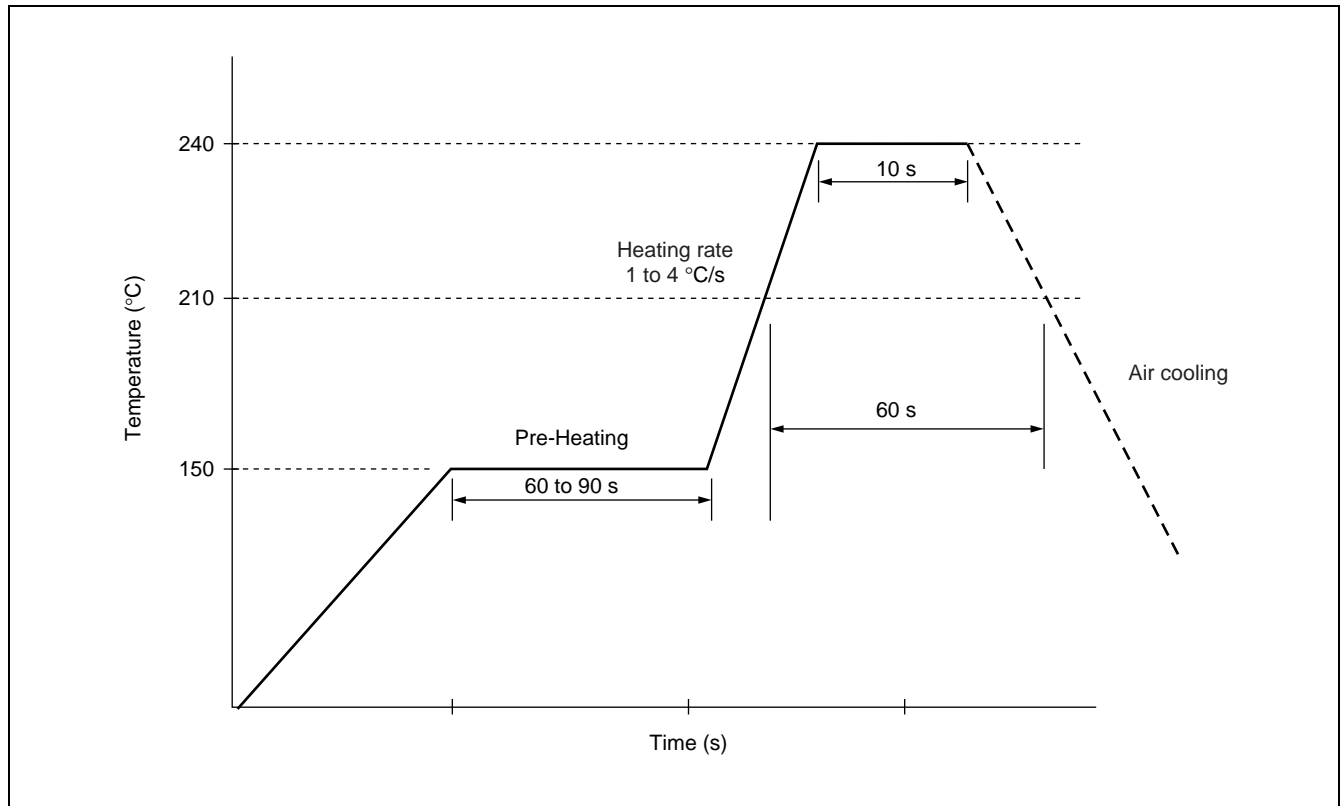

NOTE

Mass-produced product order is accepted by a unit of 1000.

D5CC Series (D1)

FUJITSU MEDIA DEVICES LIMITED

For further information please contact:

Japan

FUJITSU MEDIA DEVICES LIMITED
International Sales and Marketing Dept.
Sin-Yokohama Square Bldg., 14F,
Shin-Yokohama 2-3-12, Kouhoku-ku,
Yokohama-shi, Kanagawa 222-0033, Japan
Tel: +81-45-471-0061
Fax: +81-45-471-0076

<http://www.fujitsu.co.jp/hypertext/fmd/English/index.html>

North and South America

FUJITSU MICROELECTRONICS, INC.
3545 North First Street,
San Jose, CA 95134-1804, U.S.A.
Tel: +1-408-922-9000
Fax: +1-408-922-9179

Customer Response Center
Mon. - Fri.: 7 am - 5 pm (PST)
Tel: +1-800-866-8608
Fax: +1-408-922-9179

<http://www.fujitsumicro.com/>

Europe

FUJITSU MICROELECTRONICS EUROPE GmbH
Am Siebenstein 6-10,
D-63303 Dreieich-Buchschlag,
Germany
Tel: +49-6103-690-0
Fax: +49-6103-690-122

<http://www.fujitsu-fme.com/>

Asia Pacific

FUJITSU MICROELECTRONICS ASIA PTE. LTD.
#05-08, 151 Lorong Chuan,
New Tech Park,
Singapore 556741
Tel: +65-281-0770
Fax: +65-281-0220

<http://www.fmap.com.sg/>

F0010

© FUJITSU LIMITED Printed in Japan

All Rights Reserved.

The contents of this document are subject to change without notice. Customers are advised to consult with FUJITSU sales representatives before ordering.

The information and circuit diagrams in this document are presented as examples of semiconductor device applications, and are not intended to be incorporated in devices for actual use. Also, FUJITSU is unable to assume responsibility for infringement of any patent rights or other rights of third parties arising from the use of this information or circuit diagrams.

The contents of this document may not be reproduced or copied without the permission of FUJITSU LIMITED.

FUJITSU semiconductor devices are intended for use in standard applications (computers, office automation and other office equipments, industrial, communications, and measurement equipments, personal or household devices, etc.).

CAUTION:

Customers considering the use of our products in special applications where failure or abnormal operation may directly affect human lives or cause physical injury or property damage, or where extremely high levels of reliability are demanded (such as aerospace systems, atomic energy controls, sea floor repeaters, vehicle operating controls, medical devices for life support, etc.) are requested to consult with FUJITSU sales representatives before such use. The company will not be responsible for damages arising from such use without prior approval.

Any semiconductor devices have inherently a certain rate of failure. You must protect against injury, damage or loss from such failures by incorporating safety design measures into your facility and equipment such as redundancy, fire protection, and prevention of over-current levels and other abnormal operating conditions.

If any products described in this document represent goods or technologies subject to certain restrictions on export under the Foreign Exchange and Foreign Trade Control Law of Japan, the prior authorization by Japanese government should be required for export of those products from Japan.