

ASSP Mobile Communication Systems

SAW Filter

(700 to 1000 MHz)

F5CM Series (B2)

■ DESCRIPTION

The F5CM series of SAW filters have balanced in/unbalanced out or unbalanced in/balanced out of I/O ports. Therefore these filters are suitable for the design using balanced type of IC. By using these filters, any transforming devices, such as balun is not required.

The F5CM series filters apply to the frequency range 700 to 1000MHz. High performance has been realized with high reliability and small size by using original materials and original design.

The F5CM series filters are suitable for RF interstage filter in mobile communication systems and standard parts are available for GSM and AMPS/TDMA/CDMA standards.

■ FEATURES

- Balanced/unbalanced I/O ports
- Ultra compact and light package (3.0 mm × 3.0 mm package)
- Any external matching network is not required
- Excellent stopband attenuation
- Small inband ripple
- Surface mount package (SMT)

■ PACKAGE

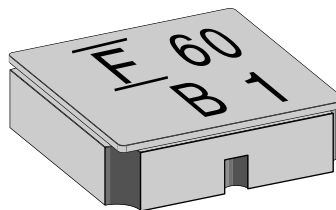

F5CM Series (B2)

■ PIN ASSIGNMENT

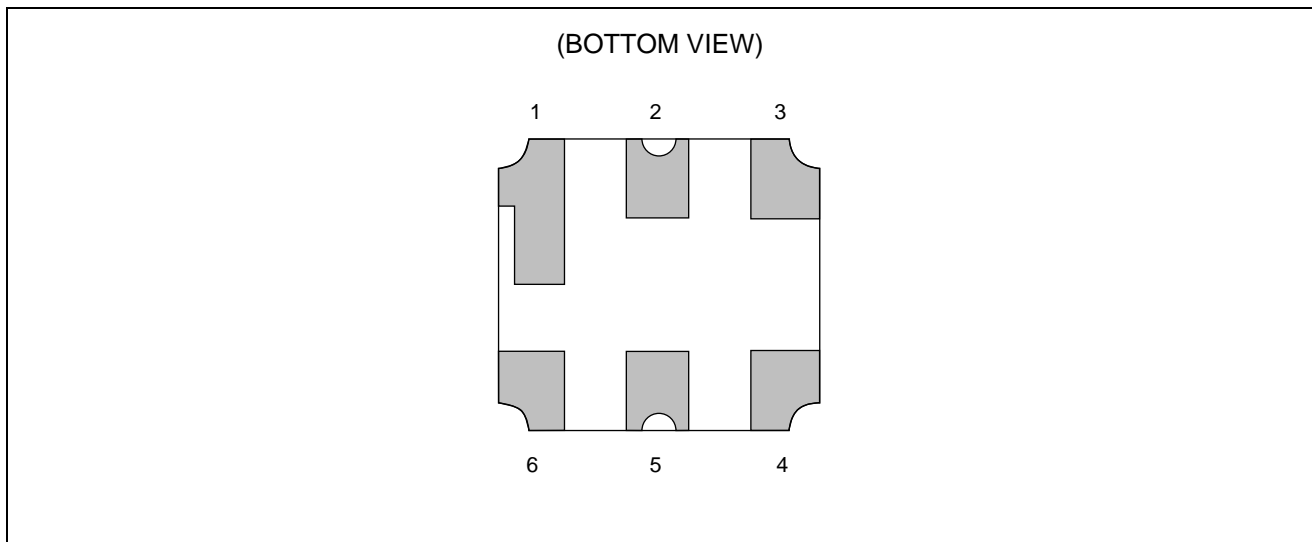

■ PIN DESCRIPTION

- BALANCED IN/UNBALANCED OUT type (Tx filter)

Pin no.	Pin name	Description
1	GND	Ground Pin
2	OUT	Unbalanced output
3	GND	Ground Pin
4	IN	Balanced Input
5	GND	Ground Pin
6	IN	Balanced Input

- UNBALANCED IN/BALANCED OUT type (Rx filter)

Pin no.	Pin name	Description
1	GND	Ground Pin
2	IN	Unbalanced Input
3	GND	Ground Pin
4	OUT	Balanced Output
5	GND	Ground Pin
6	OUT	Balanced Output

F5CM Series (B2)

■ ABSOLUTE MAXIMUM RATINGS

Parameter	Symbol	Rating		Unit
		Min.	Max.	
Operating temperature	Ta	-30	+85	°C
Storage temperature	Tstg	-40	+100	°C
Input power	Pin	—	+15	dBm
Input DC Voltage	DCin	-5	+5	V

WARNING: Piezoelectric devices can be permanently damaged by application of stress (voltage, current, temperature, etc.) in excess of absolute maximum ratings. Do not exceed these ratings.

■ RECOMMENDED OPERATING CONDITION

Parameter	Symbol	Value		Unit
		Min.	Max.	
Operating temperature	Ta	-30	+85	°C

WARNING: The recommended operating conditions are required in order to ensure the normal operation of the piezoelectric device. All of the device's electrical characteristics are warranted when the device is operated within these ranges.

Always use piezoelectric devices within their recommended operating condition ranges. Operation outside these ranges may adversely affect reliability and could result in device failure.

No warranty is made with respect to uses, operating conditions, or combinations not represented on the data sheet. Users considering application outside the listed conditions are advised to contact their FUJITSU representatives beforehand.

■ STANDARD FREQUENCIES

Applications	Frequency (MHz)	Band width (MHz)	Input type/ Impedance	Output type/ Impedance	Part number	Part symbol	
GSM	Tx	902.5	Balance 50 Ω	Unbalance 50 Ω	FAR-F5CM-902M50-B263	63	
	Rx	947.5	25	Unbalance 50 Ω	Balance 50 Ω	FAR-F5CM-947M50-B260	60
Balance 150 Ω				FAR-F5CM-947M50-B262	62		
EGSM	Rx	942.5	35	Unbalance 50 Ω	Balance 50 Ω	FAR-F5CM-942M50-B270	70
AMPS/ TDMA/ CDMA	Tx	836.5	25	Balance 50 Ω	Unbalance 50 Ω	FAR-F5CM-836M50-B268	68
	Rx	881.5	25	Unbalance 50 Ω	Balance 50 Ω	FAR-F5CM-881M50-B266	66

F5CM Series (B2)

■ ELECTRICAL CHARACTERISTICS

1. GSM (Tx) 50 ohms Balanced IN/50 ohms Unbalanced OUT

Part number: FAR-F5CM-902M50-B263

(Ta = -30°C to + 85°C)

Parameter	Conditions	Value			Unit	Remarks
		Min.	Typ.	Max.		
Insertion loss	890 to 915 MHz	—	3.2	3.5	dB	
Inband ripple	890 to 915 MHz	—	1.2	1.5	dB	
Absolute attenuation	DC to 845 MHz	45	58	—	dB	
	845 to 870 MHz	25	50	—	dB	
	935 to 980 MHz	25	30	—	dB	
	980 to 2000 MHz	40	58	—	dB	
	2000 to 3000 MHz	30	37	—	dB	

2. GSM (Rx) 50 ohms Unbalanced IN/50 ohms Balanced OUT

Part number: FAR-F5CM-947M50-B260

(Ta = -30°C to + 85°C)

Parameter	Conditions	Value			Unit	Remarks
		Min.	Typ.	Max.		
Insertion loss	935 to 960 MHz	—	3.0	3.3	dB	
Inband ripple	935 to 960 MHz	—	0.9	1.2	dB	
Absolute attenuation	DC to 890 MHz	45	56	—	dB	
	890 to 915 MHz	25	31	—	dB	
	980 to 1025 MHz	25	30	—	dB	
	1025 to 2000 MHz	40	50	—	dB	
	2000 to 3000 MHz	35	45	—	dB	

3. GSM (Rx) 50 ohms Unbalanced IN/150 ohms Balanced OUT

Part number: FAR-F5CM-947M50-B262

(Ta = -30°C to + 85°C)

Parameter	Conditions	Value			Unit	Remarks
		Min.	Typ.	Max.		
Insertion loss	935 to 960 MHz	—	3.3	3.8	dB	
Inband ripple	935 to 960 MHz	—	0.8	1.3	dB	
Absolute attenuation	DC to 890 MHz	45	55	—	dB	
	890 to 915 MHz	25	48	—	dB	
	980 to 1025 MHz	23	29	—	dB	
	1025 to 2000 MHz	40	50	—	dB	
	2000 to 3000 MHz	35	39	—	dB	

F5CM Series (B2)

4. EGSM (Rx) 50 ohms Unbalanced IN/50 ohms Balanced OUT

Part number: FAR-F5CM-942M50-B270

(Ta = -30°C to + 85°C)

Parameter	Conditions	Value			Unit	Remarks
		Min.	Typ.	Max.		
Insertion loss	925 to 960 MHz	—	3.8	4.5	dB	
Inband ripple	925 to 960 MHz	—	1.8	2.5	dB	
Absolute attenuation	DC to 880 MHz	50	55	—	dB	
	880 to 915 MHz	15	22	—	dB	
	980 to 1025 MHz	23	27	—	dB	
	1025 to 2000 MHz	40	44	—	dB	
	2000 to 3000 MHz	25	39	—	dB	

5. AMPS/TDMA/CDMA (Tx) 50 ohms Balanced IN/50 ohms Unbalanced OUT

Part number: FAR-F5CM-836M50-B268

(Ta = -30°C to + 85°C)

Parameter	Conditions	Value			Unit	Remarks
		Min.	Typ.	Max.		
Insertion loss	824 to 849 MHz	—	2.8	3.5	dB	
Inband ripple	824 to 849 MHz	—	0.9	1.6	dB	
Absolute attenuation	DC to 800 MHz	45	52	—	dB	
	869 to 920 MHz	25	33	—	dB	
	920 to 2000 MHz	35	46	—	dB	
	2000 to 3000 MHz	25	33	—	dB	

6. AMPS/TDMA/CDMA (Rx) 50 ohms Unbalanced IN/50 ohms Balanced OUT

Part number: FAR-F5CM-881M50-B266

(Ta = -30°C to + 85°C)

Parameter	Conditions	Value			Unit	Remarks
		Min.	Typ.	Max.		
Insertion loss	869 to 894 MHz	—	2.8	3.5	dB	
Inband ripple	869 to 894 MHz	—	0.8	1.5	dB	
Absolute attenuation	DC to 800 MHz	45	55	—	dB	
	800 to 849 MHz	30	47	—	dB	
	940 to 1000 MHz	30	38	—	dB	
	1000 to 2000 MHz	35	47	—	dB	
	2000 to 3000 MHz	25	32	—	dB	

F5CM Series (B2)

■ TYPICAL CHARACTERISTICS

1. GSM (Tx) 50 ohms Balanced IN/50 ohms Unbalanced OUT
Part number: FAR-F5CM-902M50-B263

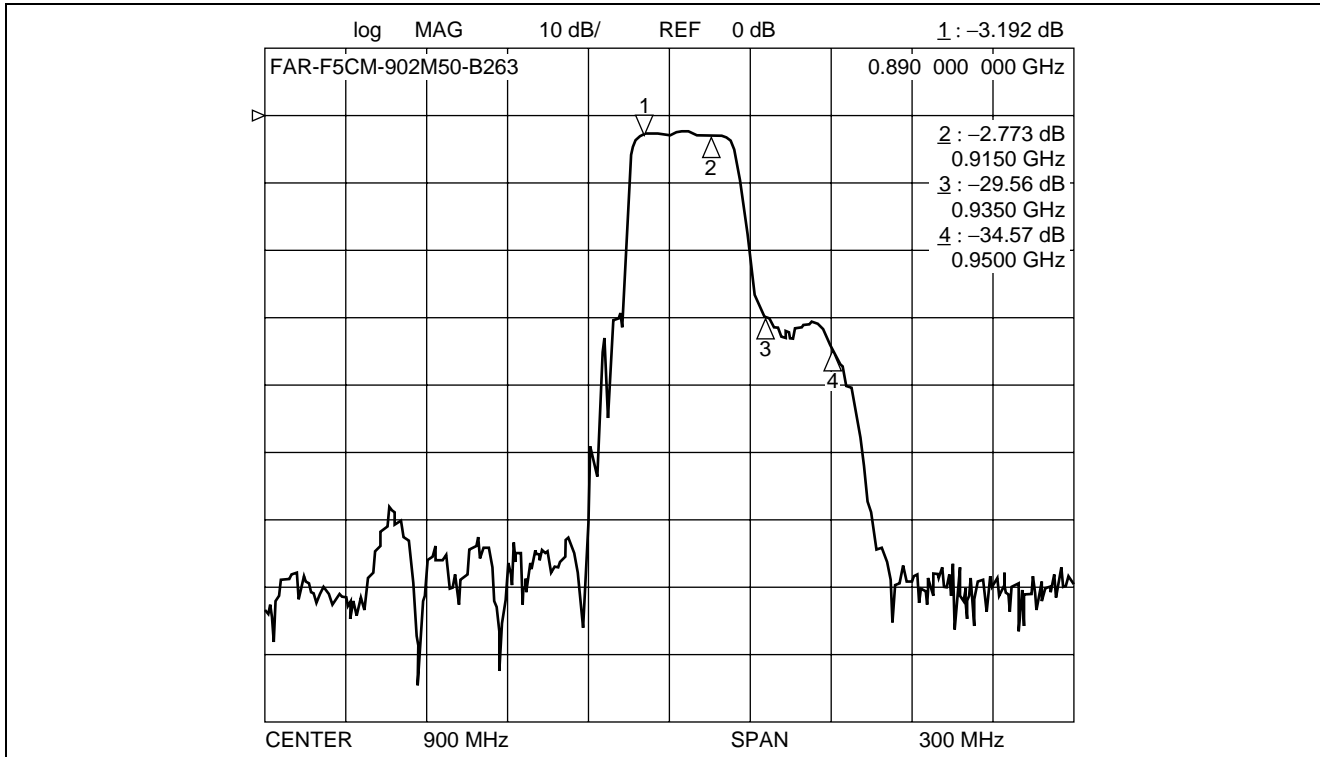

2. GSM (Rx) 50 ohms Unbalanced IN/50 ohms Balanced OUT
Part number: FAR-F5CM-947M50-B260

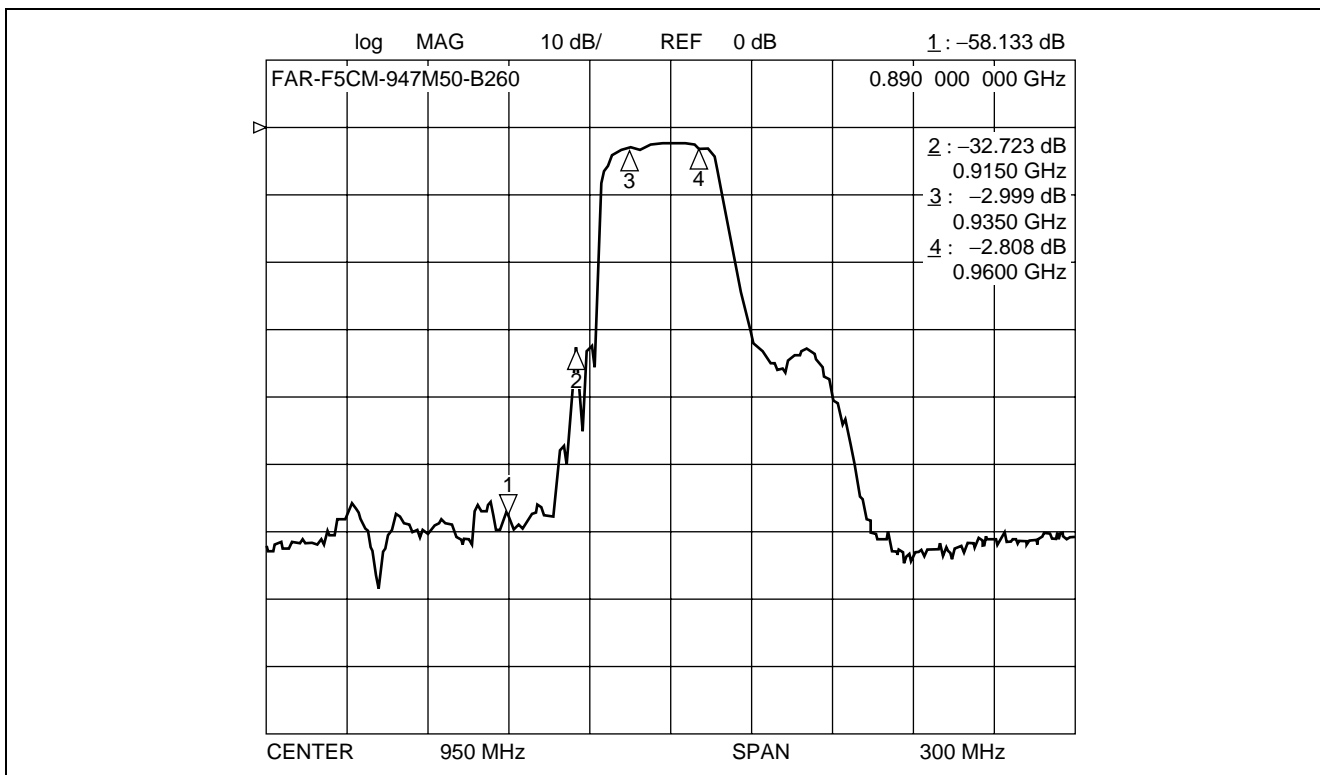

F5CM Series (B2)

3. GSM (Rx) 50 ohms Unbalanced IN/150 ohms Balanced OUT Part number: FAR-F5CM-947M50-B262

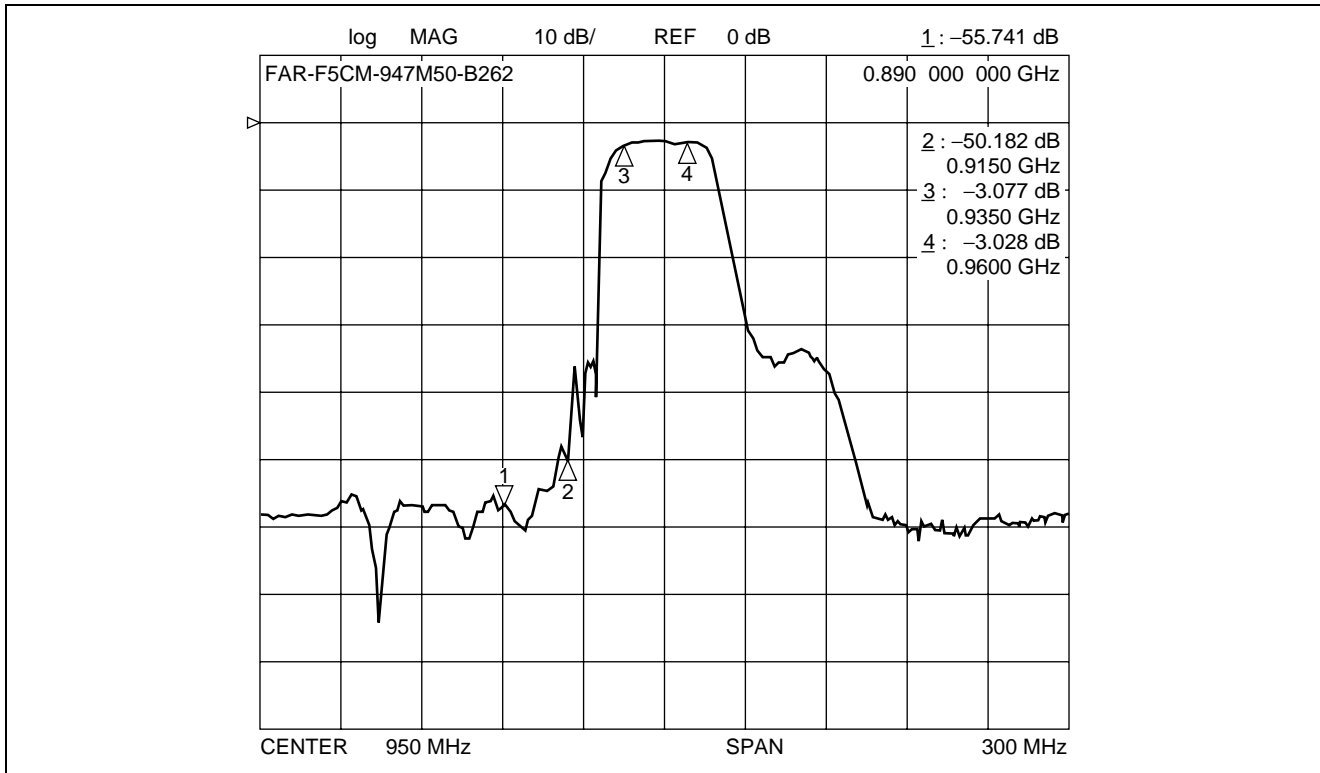

4. EGSM (Rx) 50 ohms Unbalanced IN/50 ohms Balanced OUT Part number: FAR-F5CM-942M50-B270

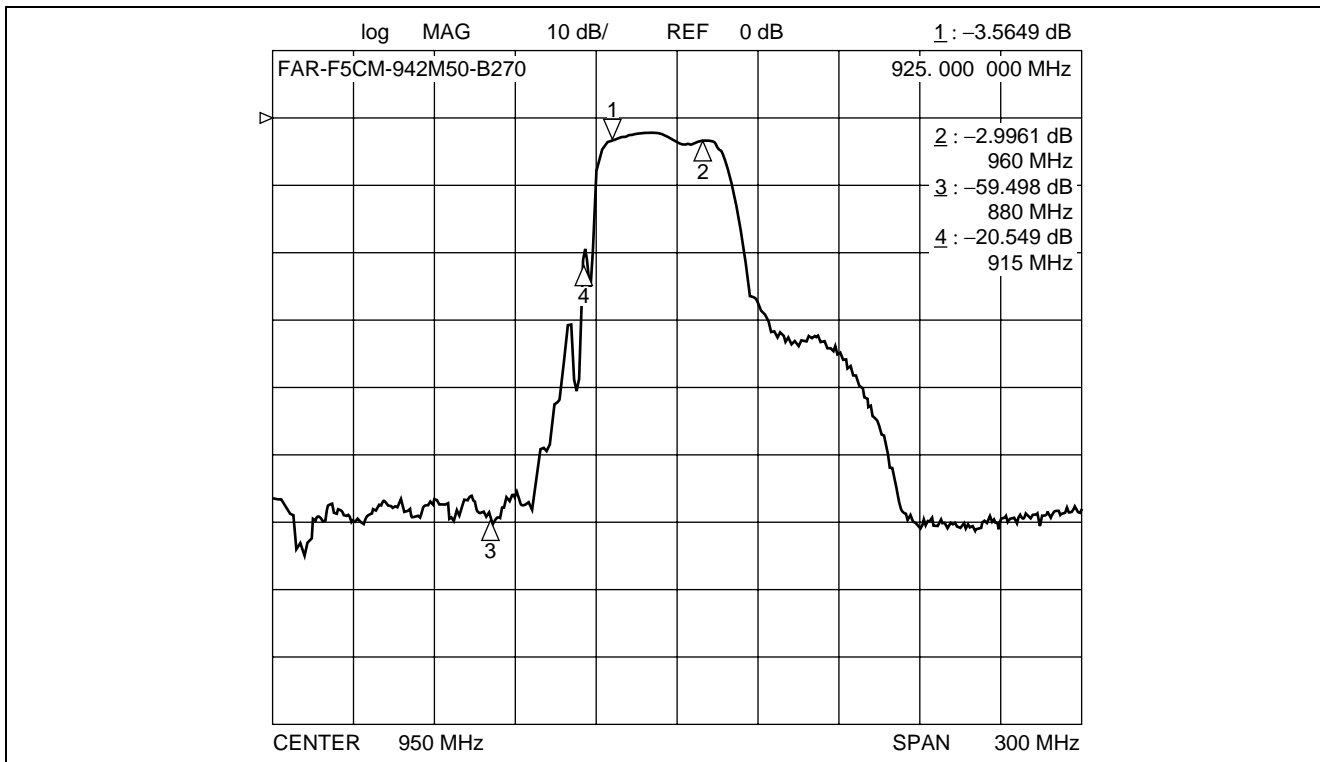

F5CM Series (B2)

5. AMSP/TDMA/CDMA (Tx) 50 ohms Balanced IN/50 ohms Unbalanced OUT Part number: FAR-F5CM-836M50-B268

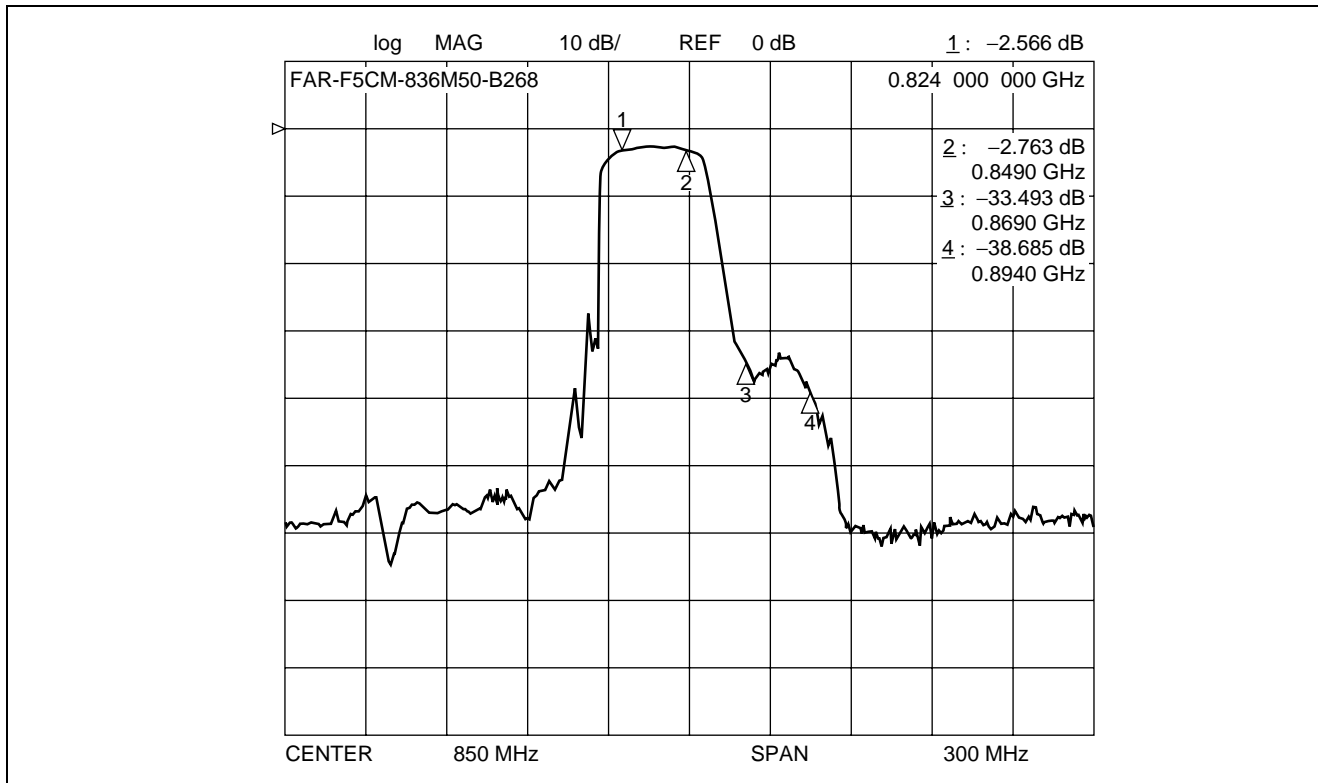

6. AMSP/TDMA/CDMA (Rx) 50 ohms Unbalanced IN/50 ohms Balanced OUT Part number: FAR-F5CM-881M50-B266

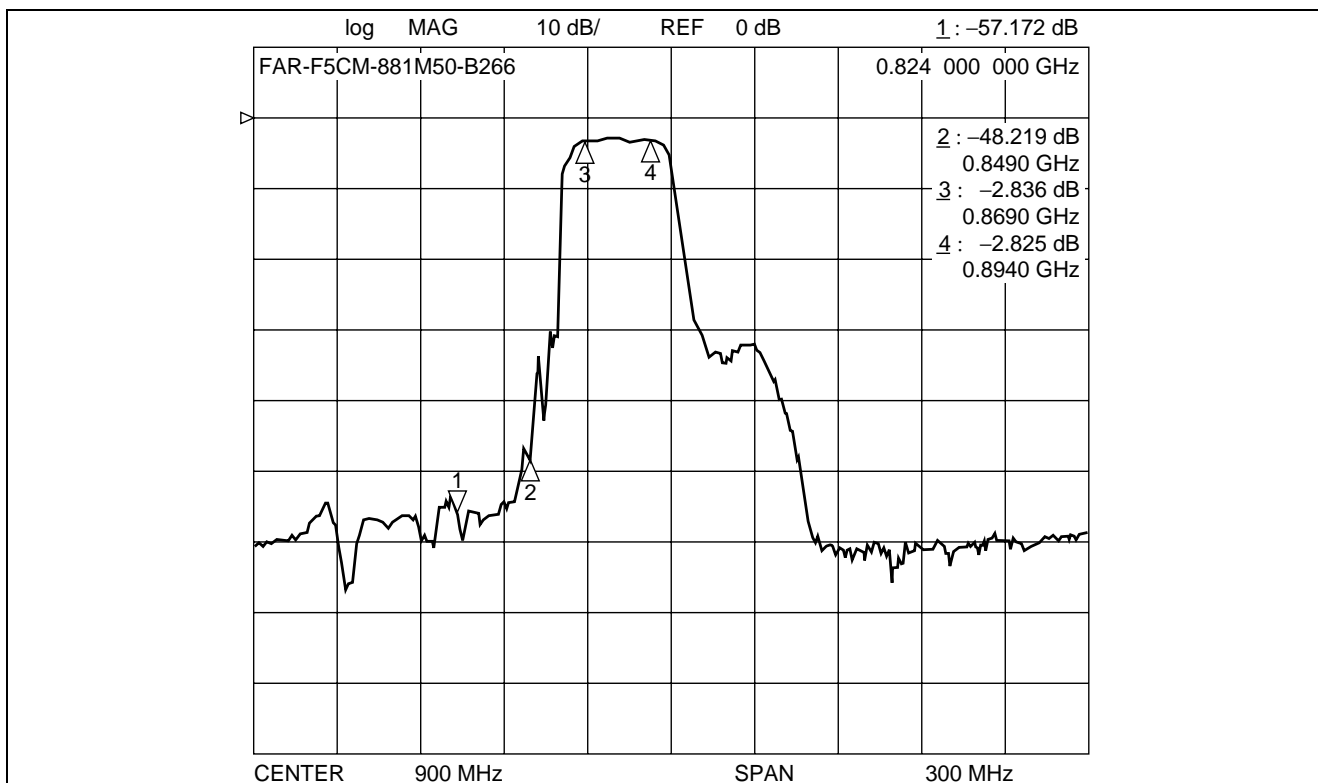

MEASUREMENT CIRCUIT

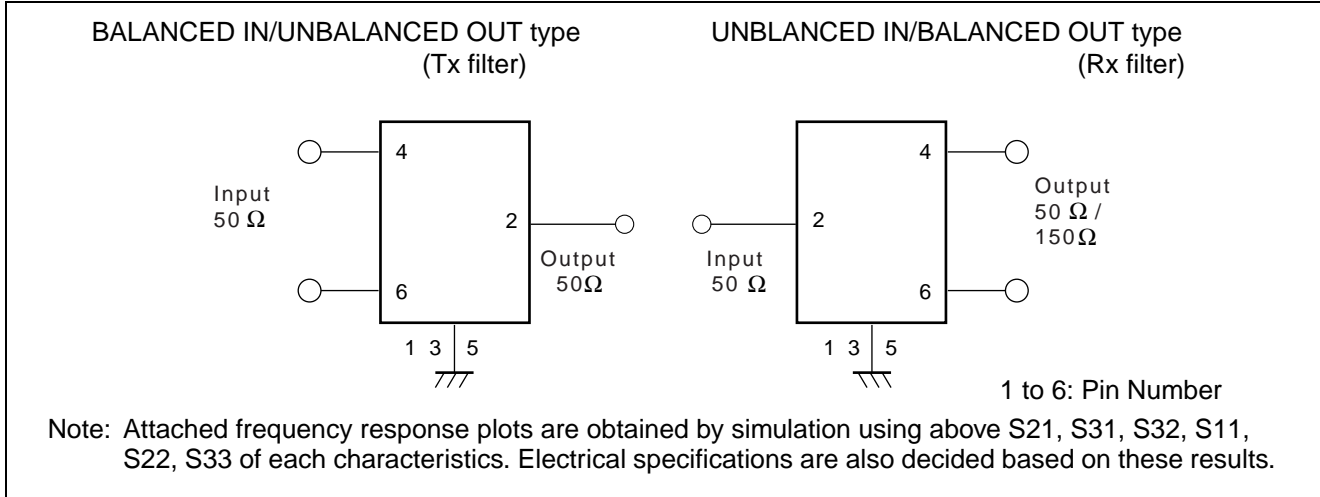

PART NUMBER DESIGNATION

[Designation example]

FAR-F5CM- -B2 -
 (1) (2) (3)

- (1) Frequency: Center frequency is specified in six alphanumeric.
Enter M (for MHz) at the decimal point.
Refer to below example.

[Example] 902.5 MHz ⇒ 902M50

- (2) Part symbol: Specified characters from 60 to 79.
- (3) Packing: W: 1000 pcs/reel
(Reeled tape) V: 3000 pcs/reel
U: 5000 pcs/reel

MARKING

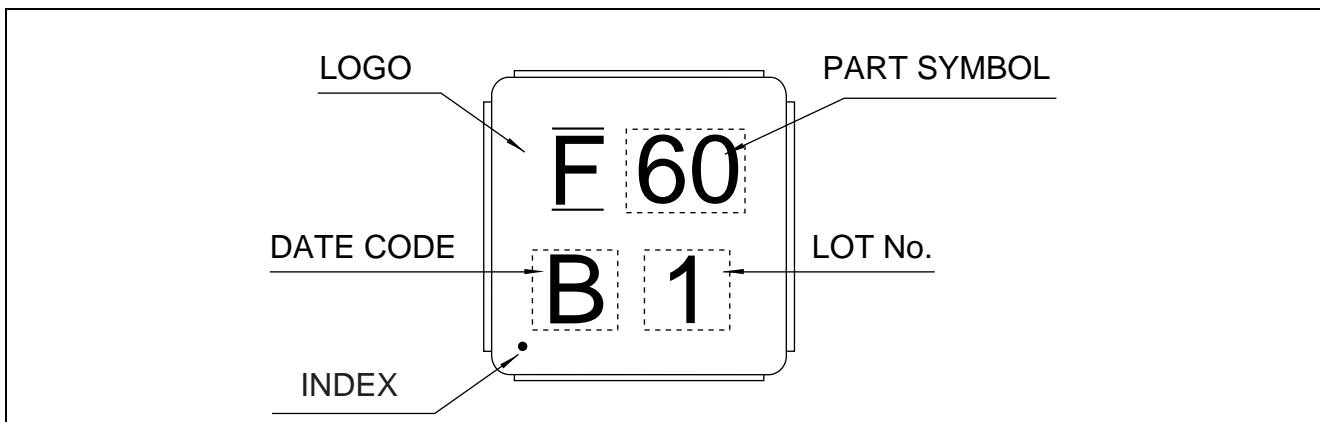

F5CM Series (B2)

■ PACKAGE DIMENSION

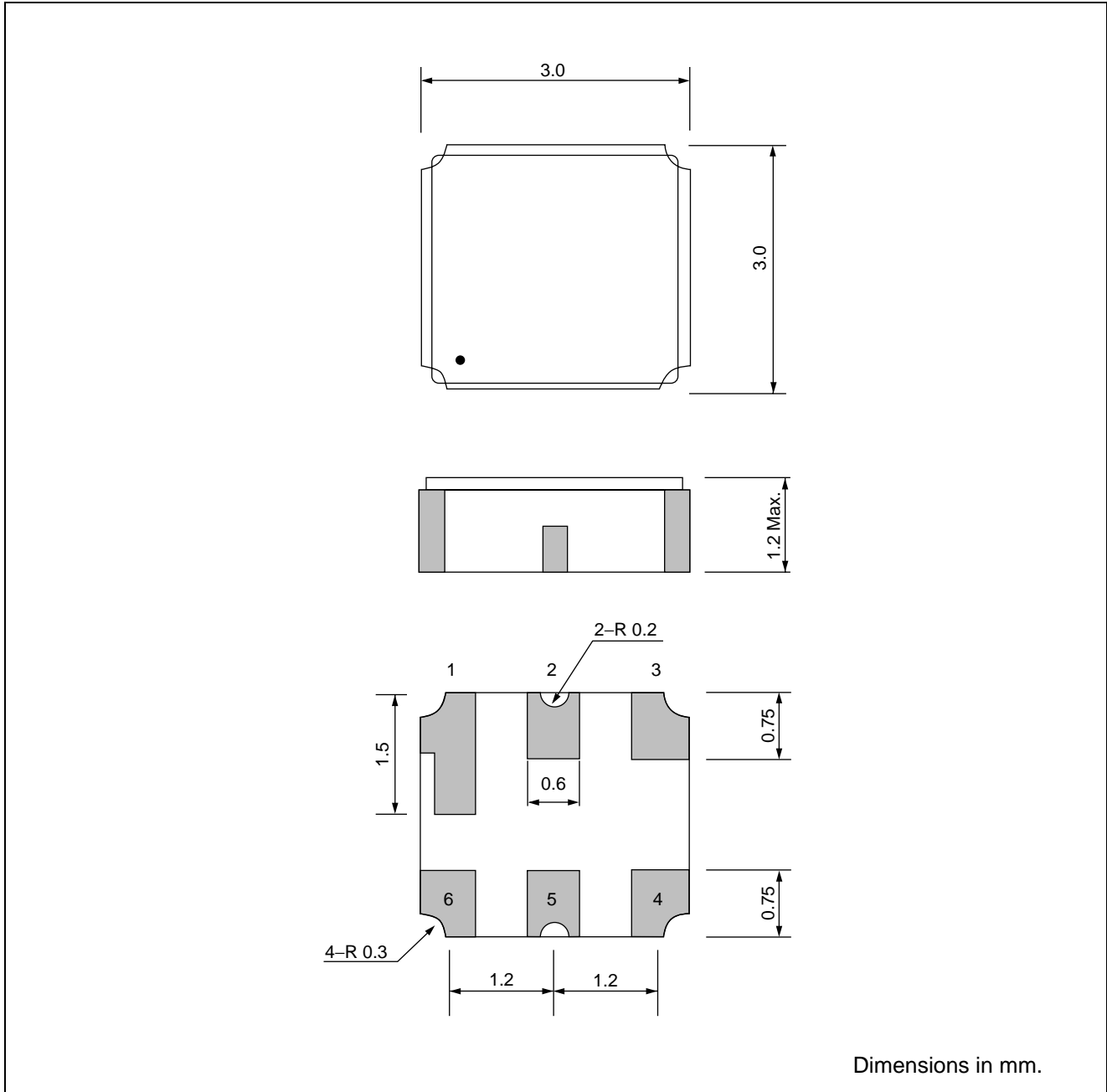

F5CM Series (B2)

■ PACKING: Reel type

1. Reel Dimensions

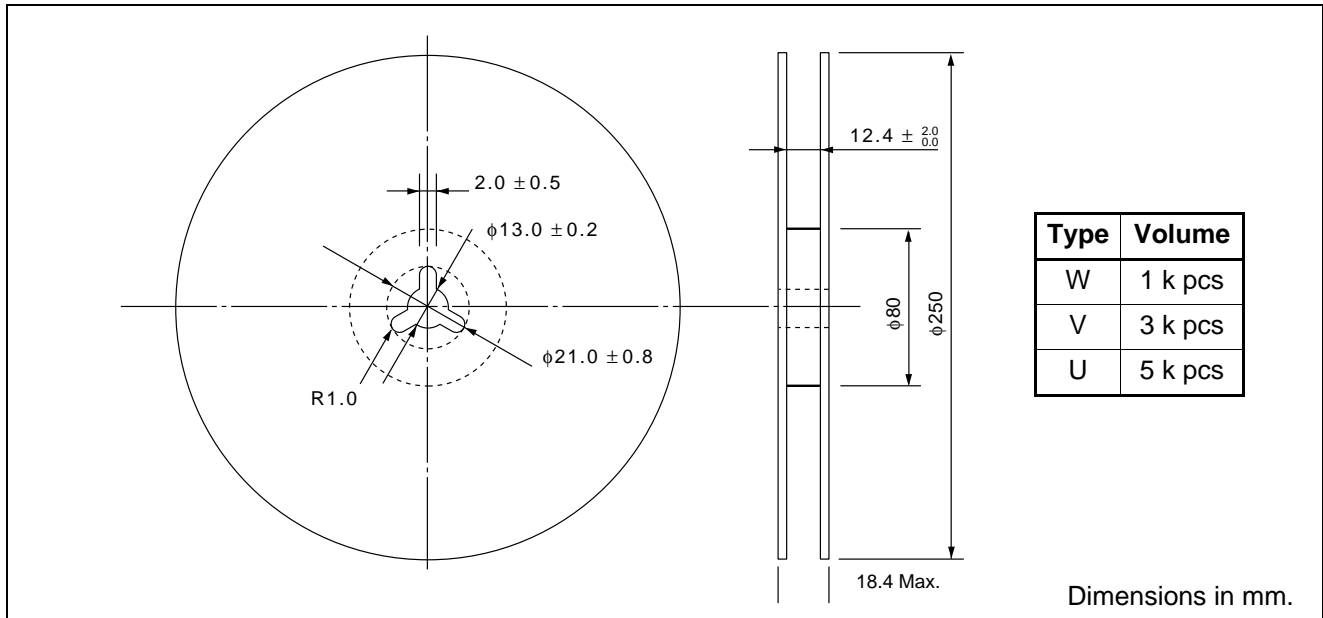

2. Packing Style

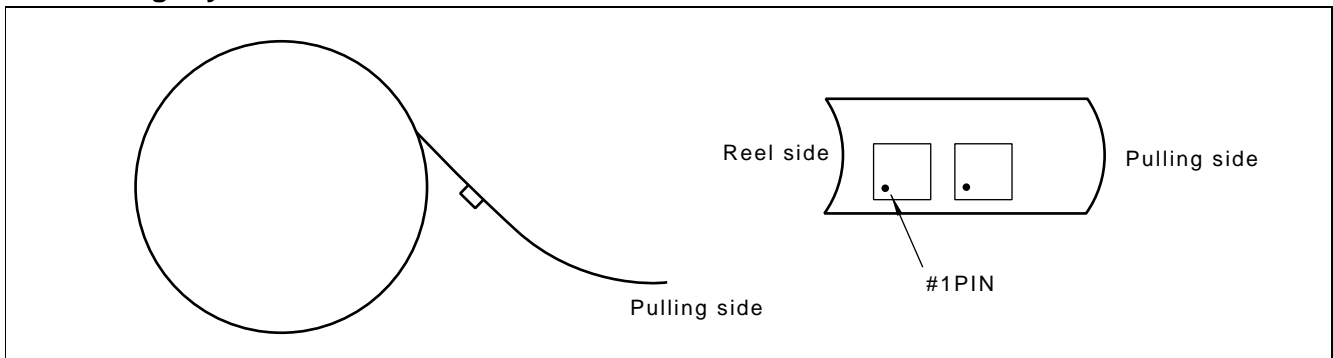

3. Tape Dimensions

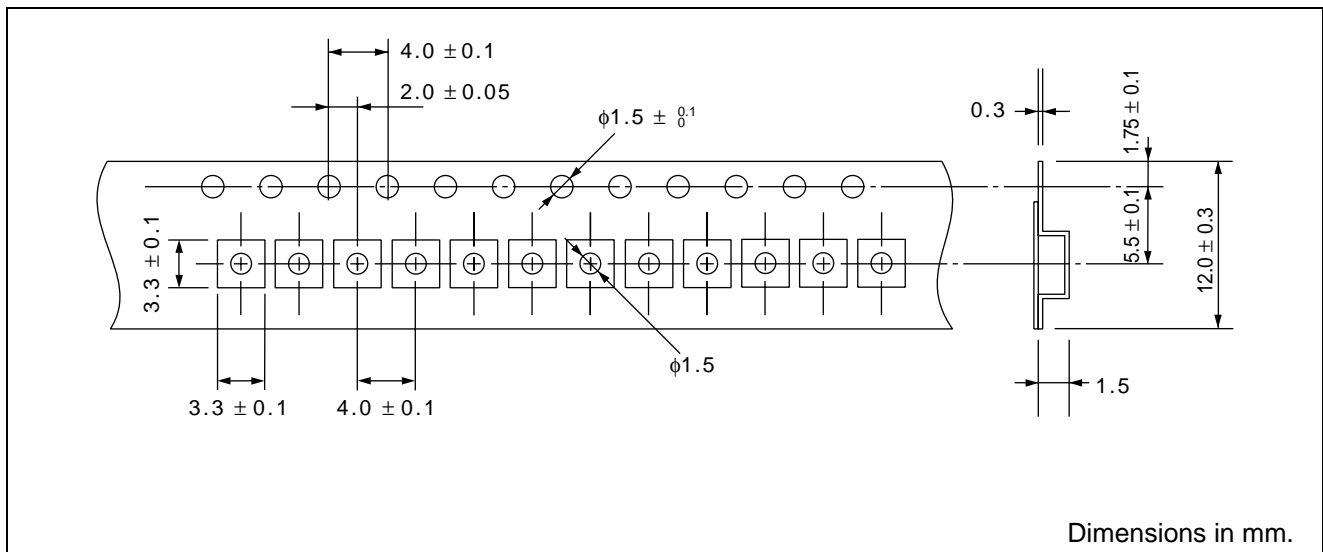

4. Peel Strength of Top Cover Tape

Peel off by the force of 0.1 N to 0.7 N under the condition at the right.
(Conforms to JIS C 0806 section 5.2)

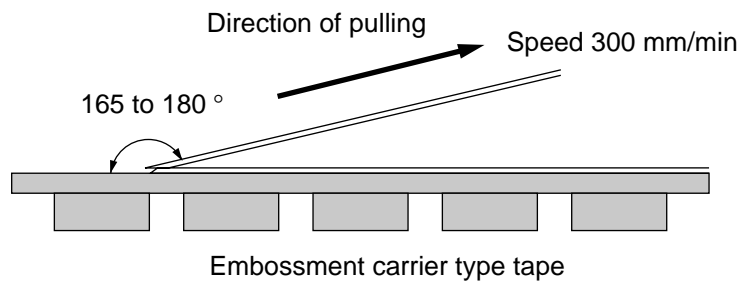

F5CM Series (B2)

RECOMMENDED REFLOW PROFILE

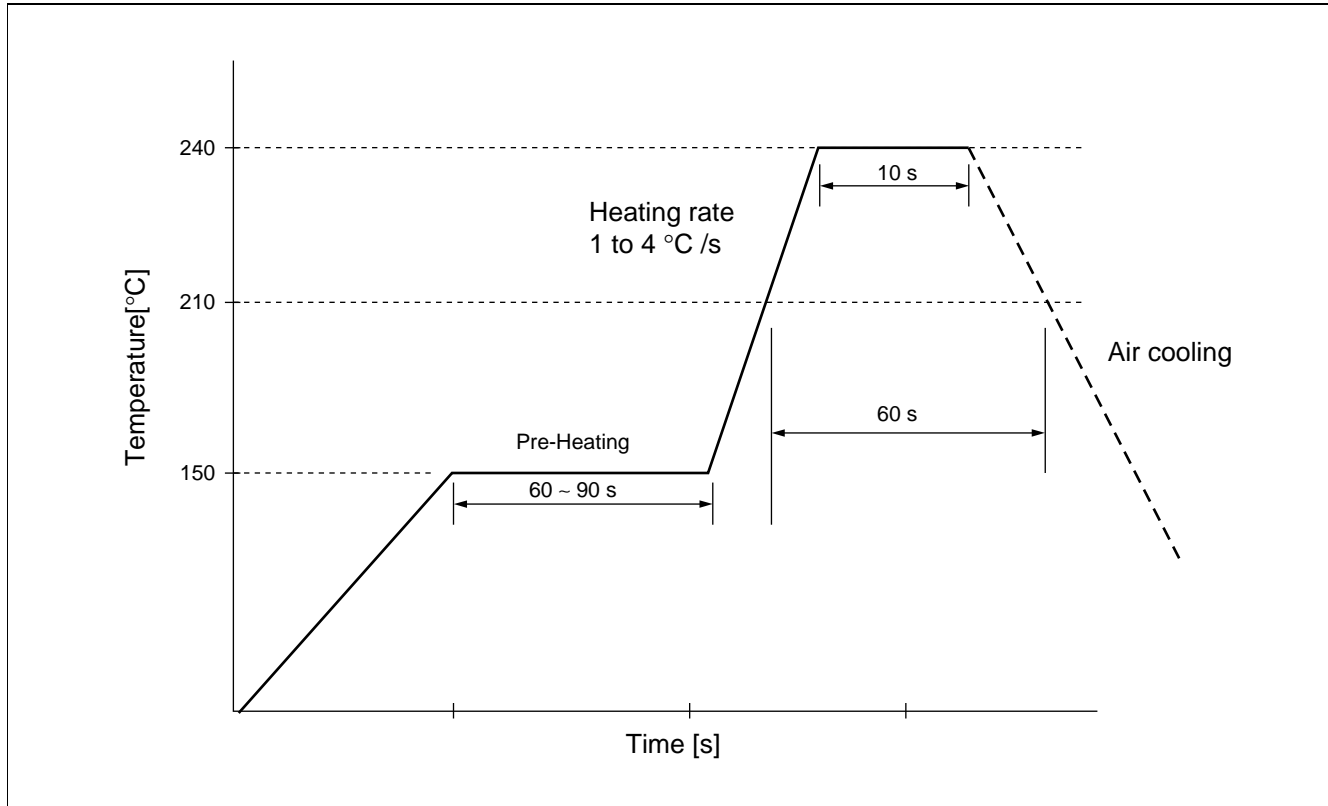

NOTE

Mass-produced product order is accepted by a unit of 1000.

F5CM Series (B2)

FUJITSU MEDIA DEVICES LIMITED

For further information please contact:

Japan

FUJITSU MEDIA DEVICES LIMITED
International Sales and Marketing Dept.
Sin-Yokohama Square Bldg., 14F,
Shin-Yokohama 2-3-12, Kouhoku-ku,
Yokohama-shi, Kanagawa 222-0033, Japan
Tel: +81-45-471-0061
Fax: +81-45-471-0076

<http://www.fujitsu.co.jp/hypertext/fmd/English/index.html>

North and South America

FUJITSU MICROELECTRONICS, INC.
3545 North First Street,
San Jose, CA 95134-1804, U.S.A.
Tel: +1-408-922-9000
Fax: +1-408-922-9179

Customer Response Center
Mon. - Fri.: 7 am - 5 pm (PST)
Tel: +1-800-866-8608
Fax: +1-408-922-9179

<http://www.fujitsumicro.com/>

Europe

FUJITSU MICROELECTRONICS EUROPE GmbH
Am Siebenstein 6-10,
D-63303 Dreieich-Buchschlag,
Germany
Tel: +49-6103-690-0
Fax: +49-6103-690-122

<http://www.fujitsu-fme.com/>

Asia Pacific

FUJITSU MICROELECTRONICS ASIA PTE. LTD.
#05-08, 151 Lorong Chuan,
New Tech Park,
Singapore 556741
Tel: +65-281-0770
Fax: +65-281-0220

<http://www.fmap.com.sg/>

F0010

© FUJITSU LIMITED Printed in Japan

All Rights Reserved.

The contents of this document are subject to change without notice. Customers are advised to consult with FUJITSU sales representatives before ordering.

The information and circuit diagrams in this document are presented as examples of semiconductor device applications, and are not intended to be incorporated in devices for actual use. Also, FUJITSU is unable to assume responsibility for infringement of any patent rights or other rights of third parties arising from the use of this information or circuit diagrams.

The contents of this document may not be reproduced or copied without the permission of FUJITSU LIMITED.

FUJITSU semiconductor devices are intended for use in standard applications (computers, office automation and other office equipments, industrial, communications, and measurement equipments, personal or household devices, etc.).

CAUTION:

Customers considering the use of our products in special applications where failure or abnormal operation may directly affect human lives or cause physical injury or property damage, or where extremely high levels of reliability are demanded (such as aerospace systems, atomic energy controls, sea floor repeaters, vehicle operating controls, medical devices for life support, etc.) are requested to consult with FUJITSU sales representatives before such use. The company will not be responsible for damages arising from such use without prior approval.

Any semiconductor devices have inherently a certain rate of failure. You must protect against injury, damage or loss from such failures by incorporating safety design measures into your facility and equipment such as redundancy, fire protection, and prevention of over-current levels and other abnormal operating conditions.

If any products described in this document represent goods or technologies subject to certain restrictions on export under the Foreign Exchange and Foreign Trade Control Law of Japan, the prior authorization by Japanese government should be required for export of those products from Japan.