

Customer Name	Standard Specification	FUJITSU MEDIA DEVICES LIMITED	
System	GPS	DATE	May 28, 2002
FMD Part Number	FAR-F6CP-1G5754-D20S	Version 1.1	Preliminary

Table 1. Electrical Specification

Passband : 1574.42 – 1576.42 MHz						
Item	Condition	Specification			Unit	Remark
		Min.	Typ.	Max.		
Insertion Loss	1574.42 – 1576.42 MHz	-	1.5	2.0	dB	
Ripple	1574.42 – 1576.42 MHz	-	0.4	0.6	dB	
Absolute Attenuation	DC – 1075.42 MHz	30	36	-	dB	@fc-500MHz
	1475.42 MHz	30	40	-	dB	@fc-100MHz
	1525.42 MHz	17	28	-	dB	@fc-50MHz
	1625.42 MHz	10	13	-	dB	@fc+50MHz
	1675.42 MHz	15	39	-	dB	@fc+100MHz
	2076.42 - 3000 MHz	25	40	-	dB	@fc+500MHz
VSWR	1574.42 – 1576.42 MHz	-	1.7	2.2		
Input/Output Impedance	-	50/50			Ohm	
Input power	-	-	-	+10	dBm	
Operating Temperature		-30 ~ +85			°C	
Device Size		2.5typ. x 2.0typ. x 1.0max.			mm	

Customer Name	Standard Specification	FUJITSU MEDIA DEVICES LIMITED	
System	GPS	DATE	May 28, 2002
FMD Part Number	FAR-F6CP-1G5754-D20S	Version 1.1	Preliminary

● **Dimensions**

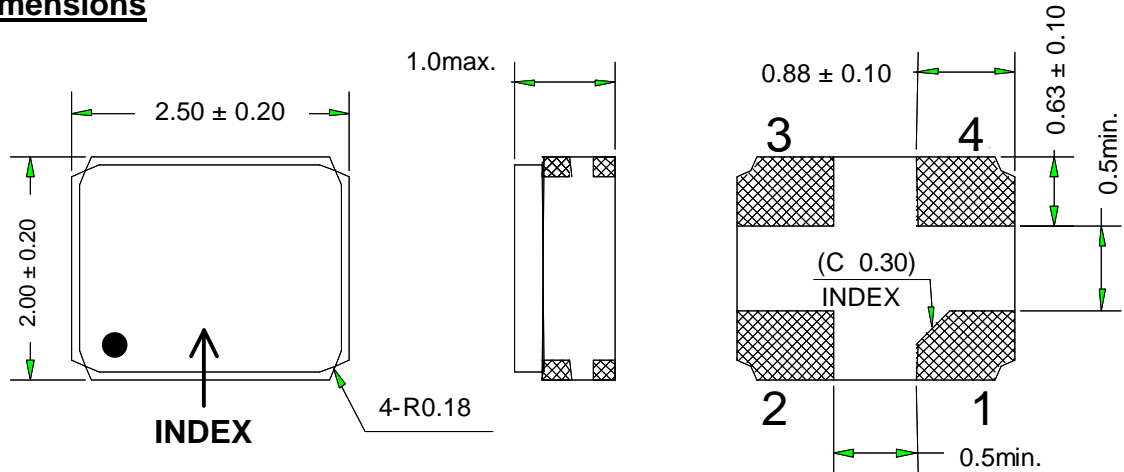

1 to 4 : Pin No.

Unit : mm

● **Pin Configuration**

Pin No.	Symbol	Function
1	IN	Input
2	GND	Ground
3	OUT	Output
4	GND	Ground

● **Evaluation Circuit**

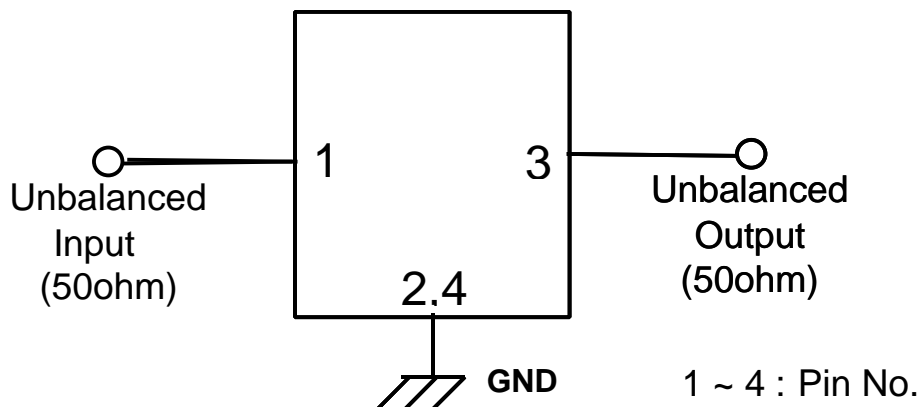

1 ~ 4 : Pin No.

Customer Name	Standard Specification	FUJITSU MEDIA DEVICES LIMITED	
System	GPS	DATE	May 28, 2002
FMD Part Number	FAR-F6CP-1G5754-D20S	Version 1.1	Preliminary

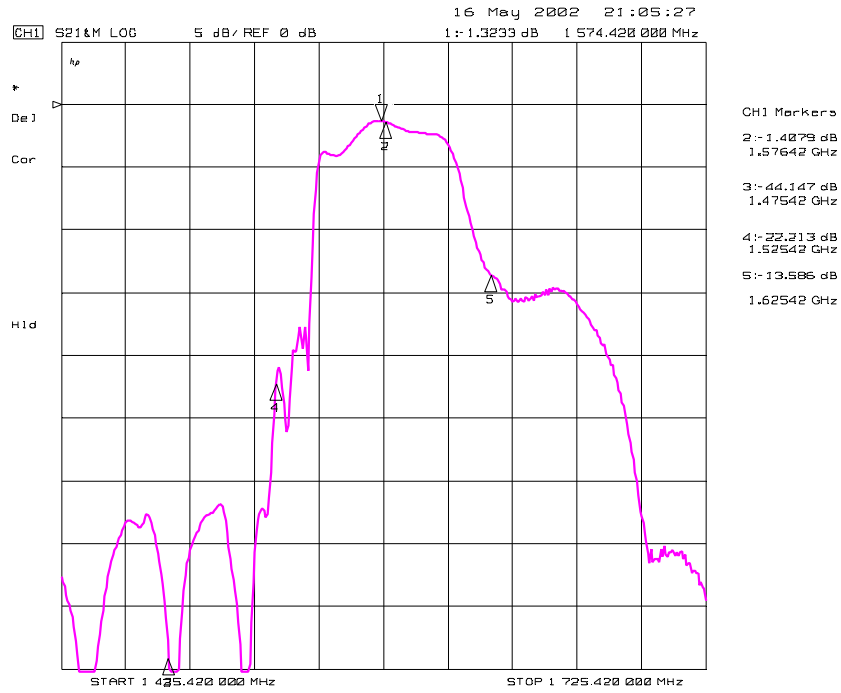

Fig. 1 Pass-band Characteristics

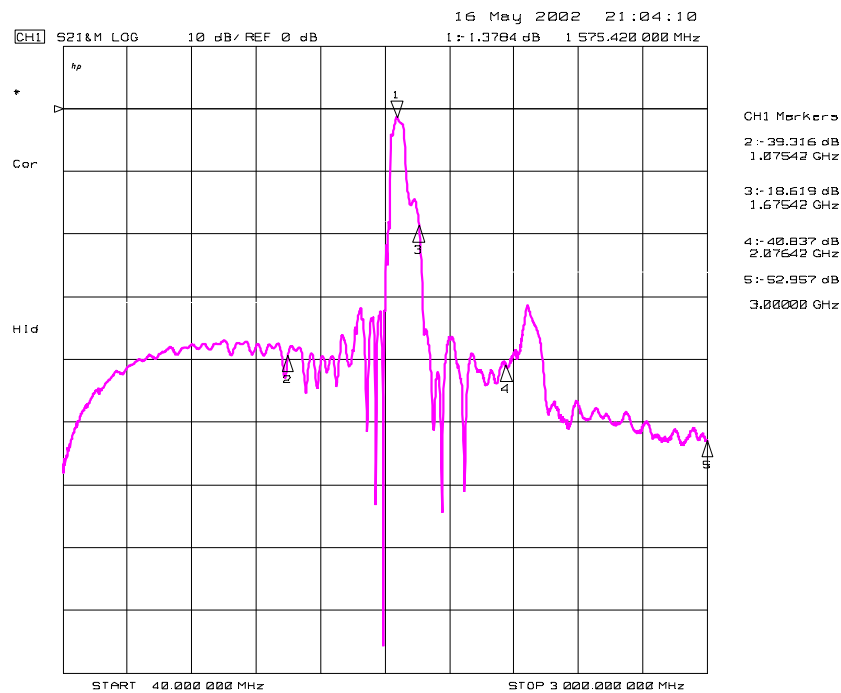

Fig. 2 Wide-band Characteristics

Customer Name	Standard Specification	FUJITSU MEDIA DEVICES LIMITED	
System	GPS	DATE	May 28, 2002
FMD Part Number	FAR-F6CP-1G5754-D20S	Version 1.1	Preliminary

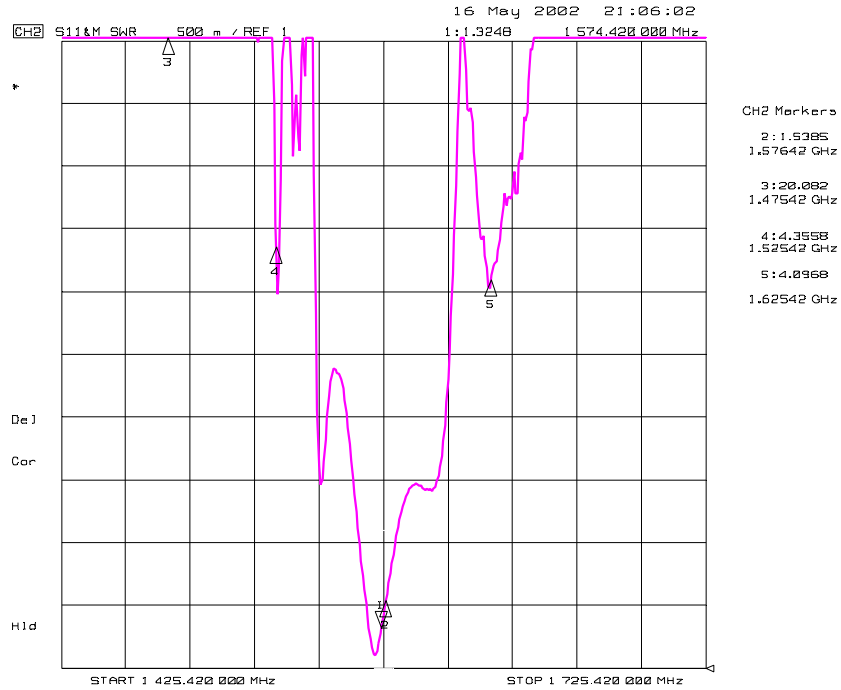

Fig. 3 VSWR (S11)

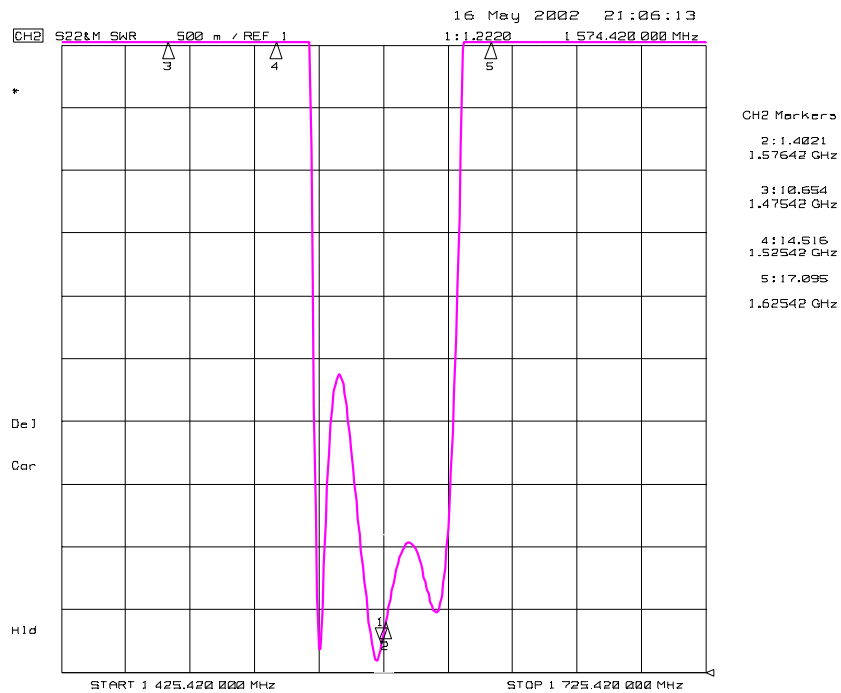

Fig. 4 VSWR (S22)

Customer Name	Standard Specification	FUJITSU MEDIA DEVICES LIMITED	
System	GPS	DATE	May 28, 2002
FMD Part Number	FAR-F6CP-1G5754-D20S	Version 1.1	Preliminary

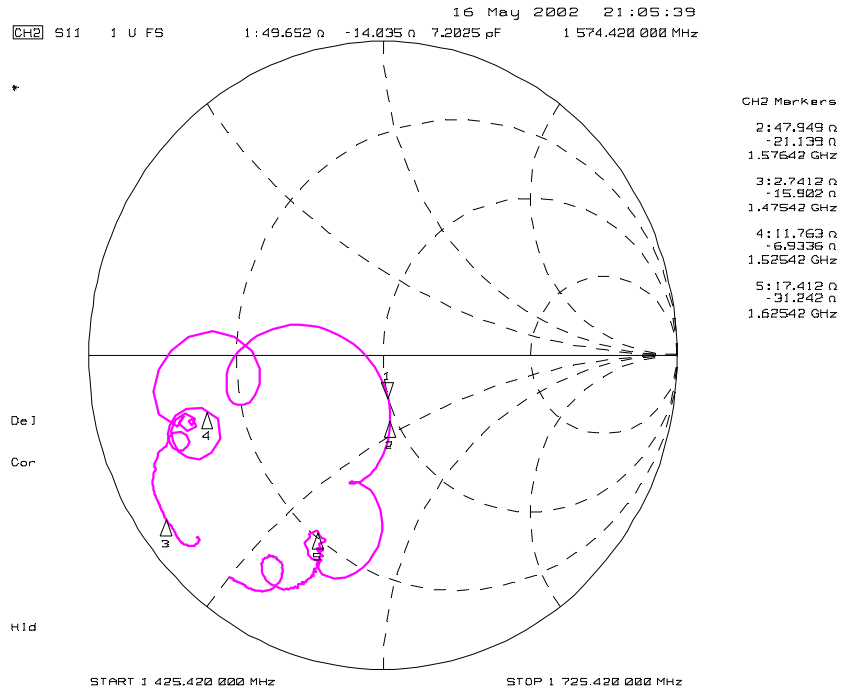

Fig. 5 Impedance (S11)

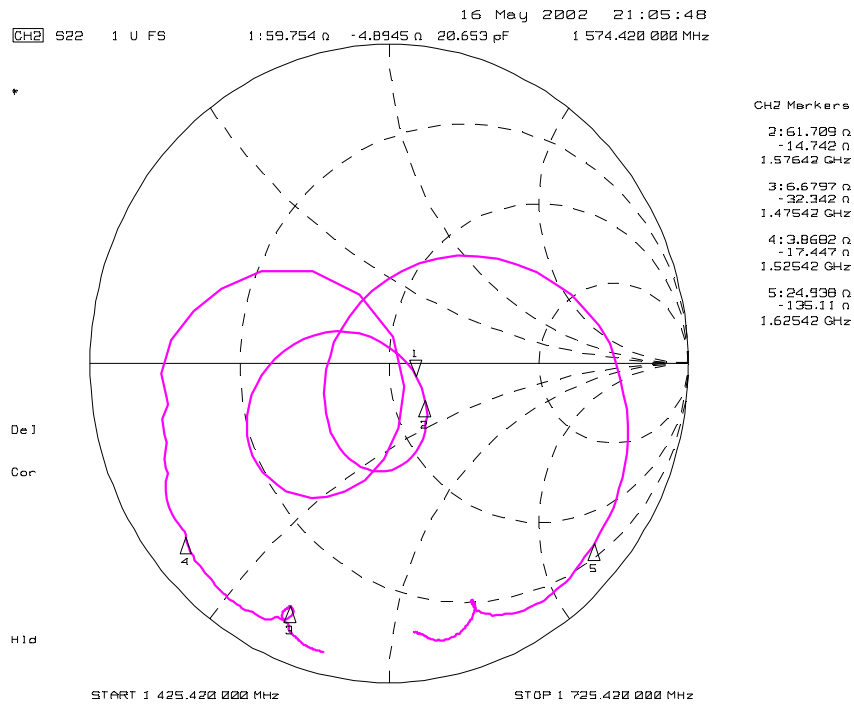

Fig. 6 Impedance (S22)