

ASSP

Piezoelectric VCO (4 to 30 MHz)

M2 Series (F100)

■ DESCRIPTION

The M2 series (F100) of VCO (Voltage Controlled Oscillator) apply to the frequency range 4-30 MHz.

The M2 series of VCO have a high reliability and wide controllable frequency ranges using a LiTaO₃ piezoelectric single crystal with high electromechanical coupling coefficient. Output level applies to CMOS type for digital interface.

■ FEATURES

- Wide frequency controllable range (Over than ± 2000 ppm)
- High carrier noise ratio
- Excellent temperature stability
- CMOS output level
- High reliability due to hermetic seal

■ PACKAGE

14 pin DIP size, Metal can package

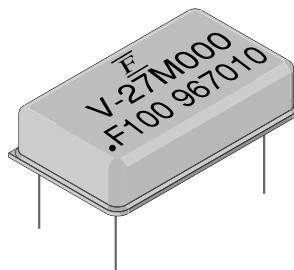

M2 Series (F100)

■ PIN ASSIGNMENT

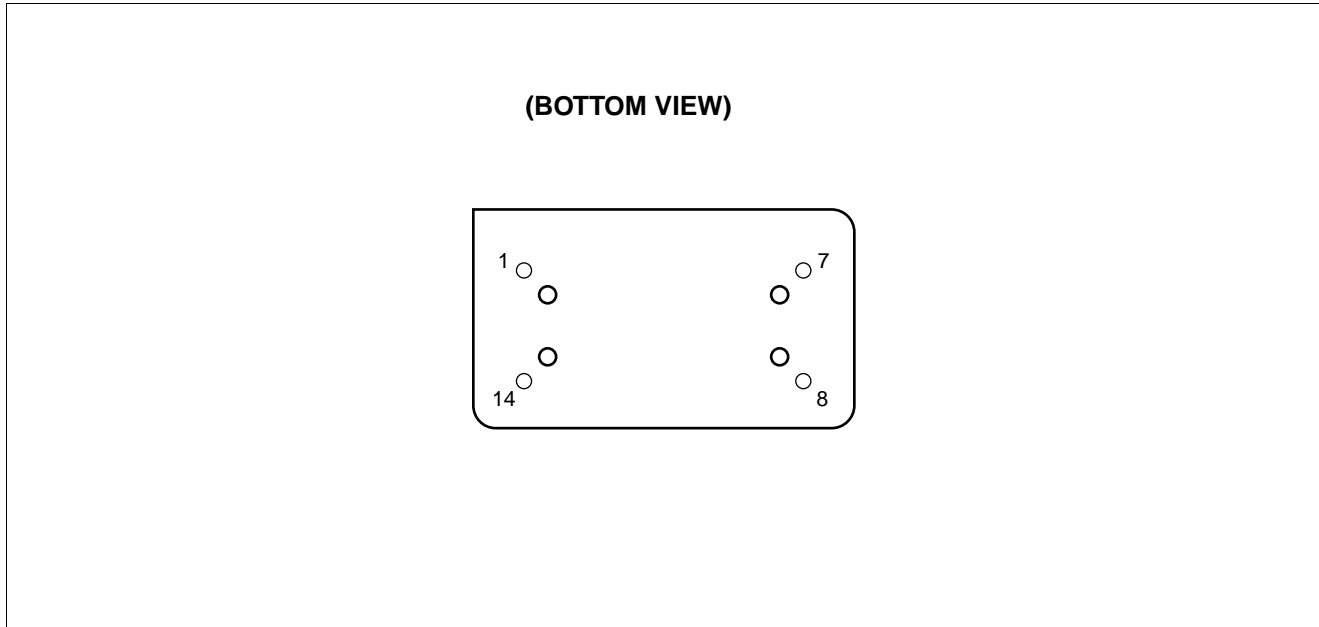

■ PIN DESCRIPTIONS

Pin Number	Symbol	Functions
1	V_{IN}	Input (Control voltage)
7	GND	Ground
8	V_{OUT}	Output
14	V_{CC}	V_{CC}

■ ABSOLUTE MAXIMUM RATINGS (See WARNING)

Parameter	Symbol	Rating	Unit
Power supply voltage	V_{CC}	-0.5 to +7.0	V
Control voltage	V_{IN}	-0.5 to +7.0	V
Operating temperature	T_a	-10 to +70	°C
Storage temperature	T_{stg}	-40 to +100	°C
Frequency range	—	+4 to +30	MHz

WARNING: Permanent device damage may occur if the above **Absolute Maximum Ratings** are exceeded. Functional operation should be restricted to the conditions as detailed in the operational sections of this data sheet. Exposure to absolute maximum rating conditions for extended periods may affect device reliability.

■ RECOMMENDED OPERATING CONDITIONS

Parameter	Symbol	Value	Unit
Power supply voltage	V_{CC}	+4.75 to +5.25	V
Control voltage	V_{IN}	+0.0 to +5.0	V
Operating temperature	T_a	-10 to +70	°C

■ STANDARD FREQUENCIES

Frequency	Application	Part number
12.288 MHz	For audio	FAR-M2DB-12M288-F100
13.500 MHz	For video	FAR-M2DB-13M500-F100
14.318 MHz	For video	FAR-M2DB-14M318-F100
18.432 MHz	For audio	FAR-M2DB-18M432-F100
21.053 MHz	For video	FAR-M2DB-21M053-F100
24.576 MHz	For audio	FAR-M2DB-24M576-F100
25.175 MHz	For video	FAR-M2DB-25M175-F100
27.000 MHz	For video	FAR-M2DB-27M000-F100
28.636 MHz	For video	FAR-M2DB-27M636-F100

M2 Series (F100)

ELECTRICAL CHARACTERISTICS

Unless otherwise specified Ta = +25 °C, Vcc = +5.0 V

Parameter	Symbol	Condition	Value			Unit	Remarks	
			Min.	Typ.	Max.			
Current consumption	I _{CC}	Without load	—	9.0	15	mA		
Output voltage	"H"	V _{OH}	V _{IN} = 2.5 V	V _{CC} - 0.5	5.0	—	V	
	"L"	V _{OL}	V _{IN} = 2.5 V	—	0	+0.5	V	
Duty ratio	DUTY	V _{IN} = 2.5 V	40	50	60	%	*	
Initial deviation of oscillation frequency	Δf _o	V _{IN} = 2.5 V	-500	—	+500	ppm		
Oscillation frequency	f _H	V _{IN} = 4.5 V	+1600	—	—	ppm	Nominal frequency reference	
	f _L	V _{IN} = 0.5 V	—	—	-1600	ppm		
Frequency stability	Δf(V _{CC})	V _{CC} = 4.75 V to 5.25 V V _{IN} = 2.5 V	-100	—	+100	ppm	V _{CC} = 5.0 V reference	
Frequency stability with temperature	Δf(T _a)	V _{IN} = 2.5 V (f _o < 23 MHz)	-500	—	+500	ppm	25°C reference	
		V _{IN} = 2.5 V (f _o ≥ 23 MHz)	-400	—	+600	ppm	T _a = -10 to +70°C	

* : Duty Ratio

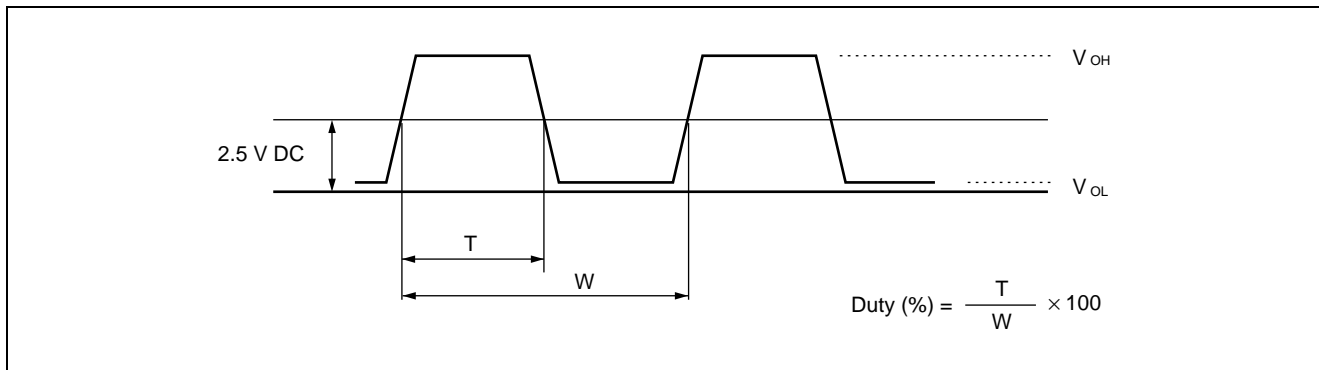

MEASUREMENT CIRCUIT

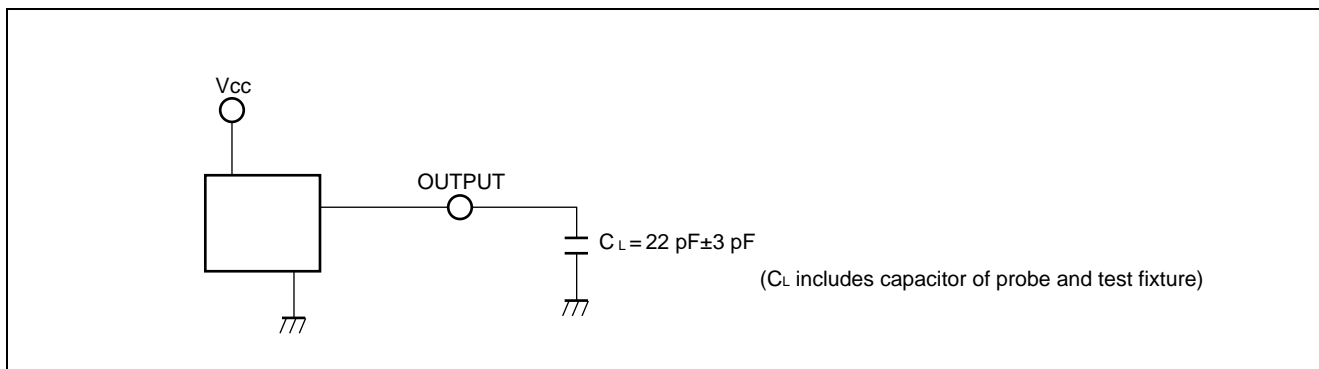

TYPICAL CHARACTERISTICS

Part number : FAR-M2DB-27M000-F100

1. Oscillation Frequency vs. Control Votage

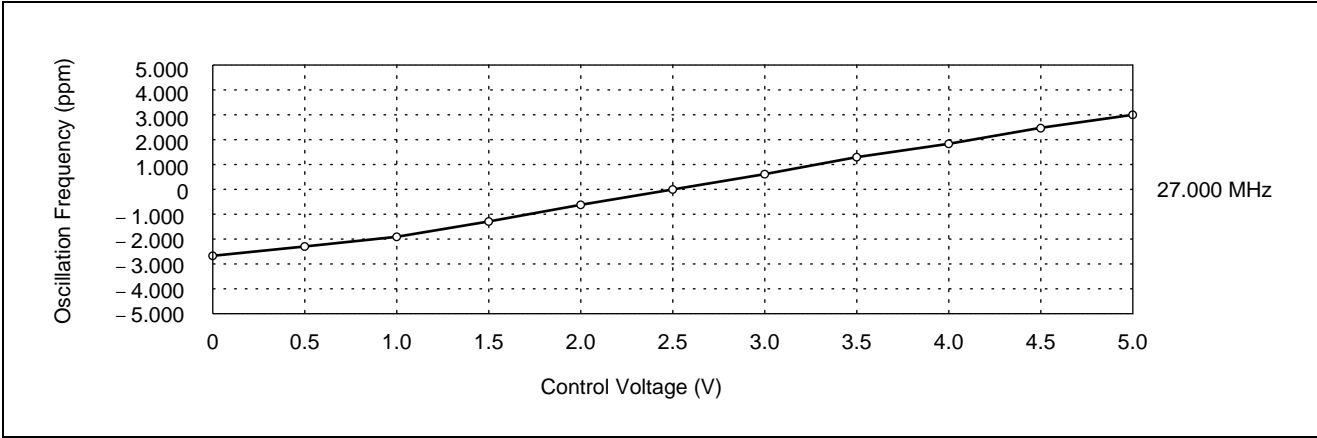

2. Frequency Stability With Temperature

(Ta = +25°C reference)

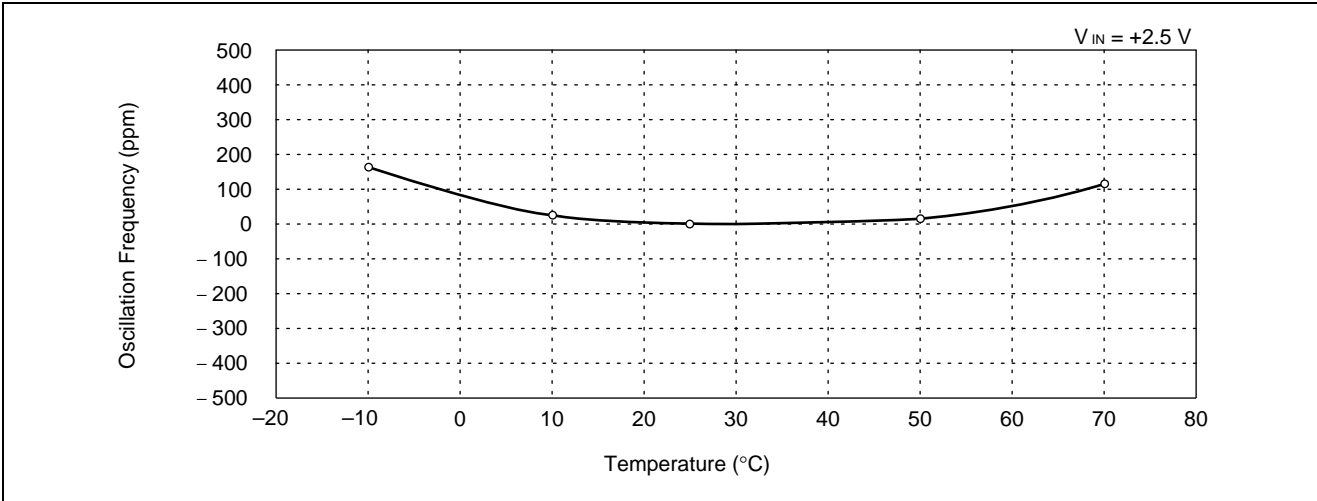

3. Frequency Stability vs. Vcc

(VCC = +50 reference)

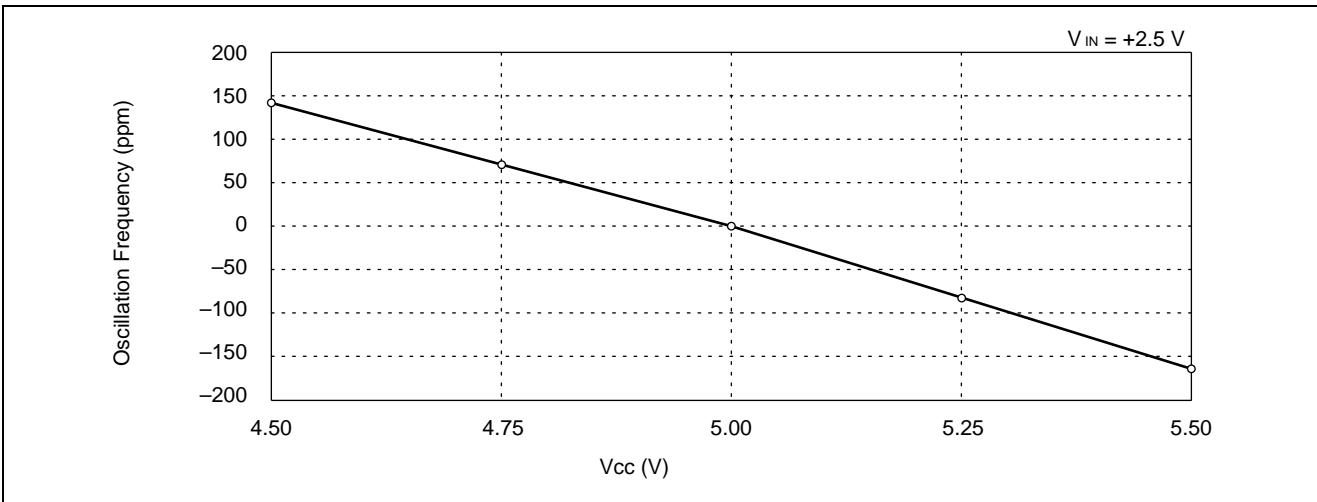

M2 Series (F100)

■ PART NUMBER DESIGNATION

[Designation example]

FAR – M2DB – □□□□□□ – F100

*

* : Frequency designation : Specify the nominal frequency in six alphanumeric characters.
Enter M at the decimal point.

[Example] 27.000 MHz → 27M000

■ MARKING

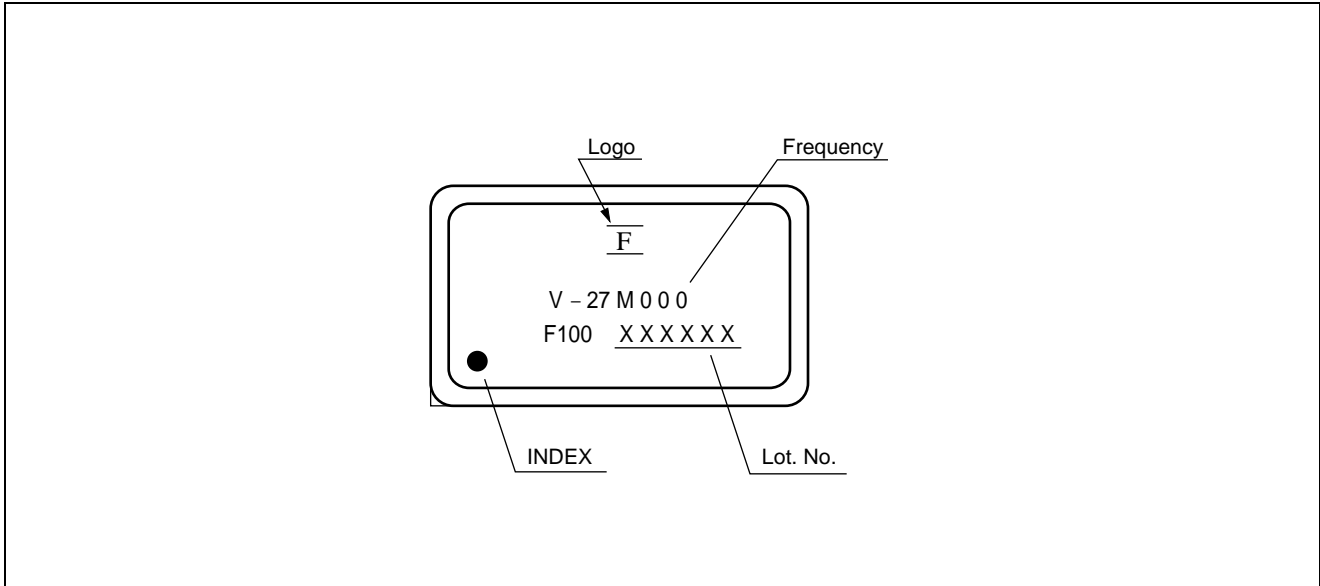

■ PACKAGE DIMENSION

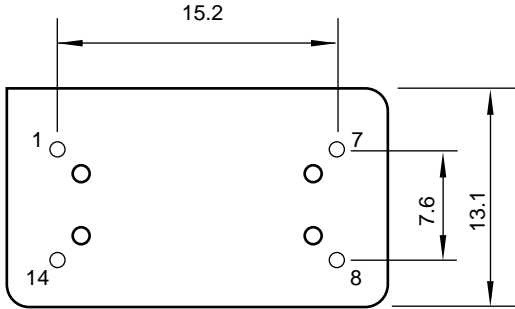
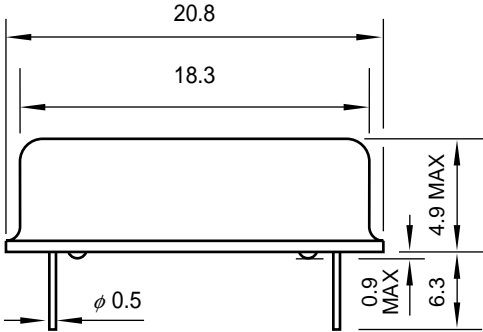
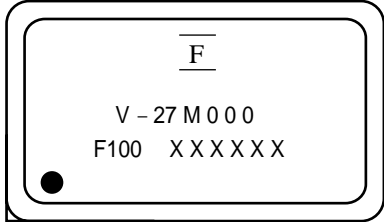

Dimensions in mm.

FUJITSU LIMITED

For further information please contact:

Japan

FUJITSU LIMITED
Corporate Global Business Support Division
Electronic Devices
KAWASAKI PLANT, 4-1-1, Kamikodanaka
Nakahara-ku, Kawasaki-shi
Kanagawa 211-88, Japan
Tel: (044) 754-3763
Fax: (044) 754-3329

North and South America

FUJITSU MICROELECTRONICS, INC.
Semiconductor Division
3545 North First Street
San Jose, CA 95134-1804, U.S.A.
Tel: (408) 922-9000
Fax: (408) 432-9044/9045

Europe

FUJITSU MIKROELEKTRONIK GmbH
Am Siebenstein 6-10
63303 Dreieich-Buchsschlag
Germany
Tel: (06103) 690-0
Fax: (06103) 690-122

Asia Pacific

FUJITSU MICROELECTRONICS ASIA PTE. LIMITED
#05-08, 151 Lorong Chuan
New Tech Park
Singapore 556741
Tel: (65) 281-0770
Fax: (65) 281-0220

All Rights Reserved.

The contents of this document are subject to change without notice. Customers are advised to consult with FUJITSU sales representatives before ordering.

The information and circuit diagrams in this document presented as examples of semiconductor device applications, and are not intended to be incorporated in devices for actual use. Also, FUJITSU is unable to assume responsibility for infringement of any patent rights or other rights of third parties arising from the use of this information or circuit diagrams.

FUJITSU semiconductor devices are intended for use in standard applications (computers, office automation and other office equipment, industrial, communications, and measurement equipment, personal or household devices, etc.).

CAUTION:

Customers considering the use of our products in special applications where failure or abnormal operation may directly affect human lives or cause physical injury or property damage, or where extremely high levels of reliability are demanded (such as aerospace systems, atomic energy controls, sea floor repeaters, vehicle operating controls, medical devices for life support, etc.) are requested to consult with FUJITSU sales representatives before such use. The company will not be responsible for damages arising from such use without prior approval.

Any semiconductor devices have inherently a certain rate of failure. You must protect against injury, damage or loss from such failures by incorporating safety design measures into your facility and equipment such as redundancy, fire protection, and prevention of over-current levels and other abnormal operating conditions.

If any products described in this document represent goods or technologies subject to certain restrictions on export under the Foreign Exchange and Foreign Trade Control Law of Japan, the prior authorization by Japanese government should be required for export of those products from Japan.