

DATA SHEET

FBL2041

FBL2041I

3.3V BTL 7-bit Futurebus+ transceiver
(standard A-port)

Product specification
Supersedes data of 1998 May 11
IC23 Data Handbook

1999 Apr 27

3.3V BTL 7-bit Futurebus+ transceiver (standard A-port)

FBL2041
FBL2041I

FEATURES

- 7-bit BTL transceiver
- Separate I/O on TTL A-port
- Inverting
- Three separate pairs of driver enables in a 1 bit, 3 bit, 3 bit arrangement
- Drives heavily loaded backplanes with equivalent load impedances down to 10Ω.
- High drive 100mA BTL open collector drivers on B-port
- Allows incident wave switching in heavily loaded backplane buses
- Reduced BTL voltage swing produces less noise and reduces power consumption
- Built-in precision band-gap reference provides accurate receiver thresholds and improved noise immunity
- Compatible with IEEE Futurebus+ or proprietary BTL backplanes
- Controlled output ramp and multiple GND pins minimize ground bounce
- Each BTL driver has a dedicated Bus GND for a signal return
- Glitch-free power up/power down operation
- Low I_{CC} current
- Tight output skew
- Supports live insertion
- Pins for the optional JTAG boundary scan function are provided
- High density packaging in plastic Quad Flatpack
- 5V compatible I/O on A-port
- Industrial temperature range option available as FBL2041I

DESCRIPTION

The FBL2041/FBL2041I is a 7-bit bidirectional BTL transceiver and is intended to provide the electrical interface to a high performance wired-OR bus. The FBL2041 is an inverting transceiver.

The B-port drivers are Low-capacitance open collectors with controlled ramp and are designed to sink 100mA. Precision band gap references on the B-port insure very good noise margins by limiting the switching threshold to a narrow region centered at 1.55V.

The FBL2041/FBL2041I is pin and function compatible with FB2041 but operates at a 3.3V supply voltage, greatly reducing power consumption.

The B-port interfaces to "Backplane Transceiver Logic" (See the IEEE 1194.1 BTL standard). BTL features low power consumption by reducing voltage swing (1Vp-p, between 1V and 2V) and reduced capacitive loading by placing an internal series diode on the drivers. BTL also provides incident wave switching, a necessity for high performance backplanes.

There are three separate pairs of driver enables in a 1 bit, 3 bit, 3 bit arrangement. The TTL/BTL output drivers for bit 0 are enabled with OEA1/OEB1, output drivers for bits 1–2–3 are enabled with OEA2/OEB2 and output drivers for bits 4–5–6 are enabled with OEA3/OEB3.

The A-port operates at TTL levels with separate I/O. The 3-state A-port drivers are enabled when OEAn goes High after an extra 6ns delay which is built in to provide a break-before-make function. When OEAn goes Low, A-port drivers become High impedance without any extra delay. During power on/off cycles, the A-port drivers are held in a High impedance state when V_{CC} is below 1.3V.

The B-port has an output enable, OEB0, which affects all seven drivers. When OEB0 is High and OE $\overline{B}n$ is Low the output driver will be enabled. When OEB0 is Low or if OE $\overline{B}n$ is High, the B-port drivers will be inactive and at the level of the backplane signal.

To support live insertion, OEB0 is held Low during power on/off cycles to insure glitch free B port drivers. Proper bias for B port drivers during live insertion is provided by the BIAS V pin when at a 3.3V level while V_{CC} is Low. If live insertion is not a requirement, the BIAS V pin should be tied to a V_{CC} pin.

The LOGIC GND and BUS GND pins are isolated in the package to minimize noise coupling between the BTL and TTL sides. These pins should be tied to a common ground external to the package.

Each BTL driver has an associated BUS GND pin that acts as a signal return path and these BUS GND pins are internally isolated from each other. In the event of a ground return fault, a "hard" signal failure occurs instead of a pattern dependent error that may be very infrequent and impossible to trouble-shoot.

JTAG boundary scan functionality is provided as an option with signals TMS, TCK, TDI and TDO. When this option is not present, TMS and TCK are no-connects (no bond wires) and TDI and TDO are shorted together internally.

QUICK REFERENCE DATA

SYMBOL	PARAMETER	TYPICAL	UNIT
t _{PLH} t _{PHL}	Propagation delay AIn to $\overline{B}n$	4.2 3.5	ns
t _{PLH} t _{PHL}	Propagation delay $\overline{B}n$ to AOn	4.8 4.9	ns
C _{OB}	Output capacitance ($\overline{B}0$ - $\overline{B}6$ only)	6	pF
I _{OL}	Output current ($\overline{B}0$ - $\overline{B}6$ only)	100	mA
I _{CC}	Supply Current	Standby	5.2
		AIn to $\overline{B}n$ (outputs Low or High)	3.2
		$\overline{B}n$ to AOn (outputs Low)	13.5
		$\overline{B}n$ to AOn (outputs High)	10.7

ORDERING INFORMATION

PACKAGE	COMMERCIAL RANGE V _{CC} = 3.3V±10%; T _{amb} = 0 to +70°C	INDUSTRIAL RANGE V _{CC} = 3.3V±10%; T _{amb} = -40 to +85°C	DWG No.
52-pin Plastic Quad Flatpack	FBL2041 BB	FBL2041I BB	SOT379-1

3.3V BTL 7-bit Futurebus+ transceiver (standard A-port)

FBL2041
FBL2041I

PIN CONFIGURATION

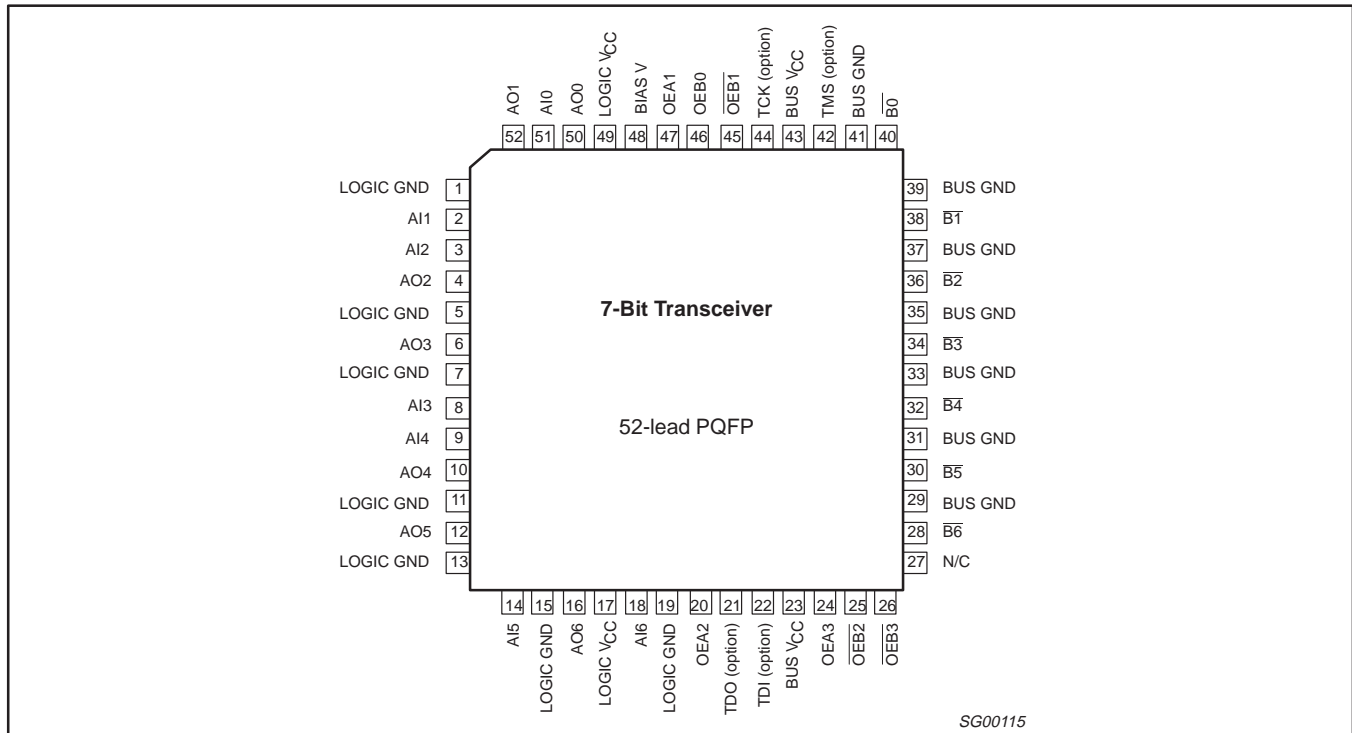

PIN DESCRIPTION

SYMBOL	PIN NUMBER	TYPE	NAME AND FUNCTION
AI0 – AI6	51, 2, 3, 8, 9, 14, 18	Input	Data inputs (TTL)
AO0 – AO6	50, 52, 4, 6, 10, 12, 16	Output	3-State outputs (TTL)
$\overline{B0} - \overline{B6}$	40, 38, 36, 34, 32, 30, 28	I/O	Data inputs/Open Collector outputs, High current drive (BTL)
OEB0	46	Input	Enables the Bn outputs when High
$\overline{OEB1}$	45	Input	Enables the B0 output when Low
$\overline{OEB2}$	25	Input	Enables the B1 – B3 outputs when Low
$\overline{OEB3}$	26	Input	Enables the B4 – B6 outputs when Low
OEA1	47	Input	Enables the A0 outputs when High
OEA2	20	Input	Enables the A1 – A3 outputs when High
OEA3	24	Input	Enables the A4 – A6 outputs when High
BUS GND	41, 39, 37, 35, 33, 31, 29	GND	Bus ground (0V)
LOGIC GND	1, 5, 7, 11, 13, 15, 19	GND	Logic ground (0V)
BUS V _{CC}	23, 43	Power	Positive supply voltage
LOGIC V _{CC}	17, 49	Power	Positive supply voltage BAND GAP
BIAS V	48	Power	Positive supply voltage
TMS	42	Input	Test Mode Select (no-connect)
TCK	44	Input	Test Clock (no-connect)
TDI	22	Input	Test Data In (shorted to TDO)
TDO	21	Output	Test Data Out (TDI)
N/C	27	—	Not connected

3.3V BTL 7-bit Futurebus+ transceiver (standard A-port)

FBL2041
FBL2041I

FUNCTION TABLE

MODE	INPUTS									OUTPUTS	
	AIn	Bn*	OEB0	OEB1	OEB2	OEB3	OEA1	OEA2	OEA3	AOn	Bn*
AIn to Bn	L	—	H	L	L	L	L	L	L	Z	H**
	H	—	H	L	L	L	L	L	L	Z	L
	L	—	H	L	L	L	H	H	H	L	H**
	H	—	H	L	L	L	H	H	H	H	L
AI0 to B0	L	—	H	L	X	X	L	L	L	Z	H**
	H	—	H	L	X	X	L	L	L	Z	L
	L	—	H	L	X	X	H	H	H	L	H**
	H	—	H	L	X	X	H	H	H	H	L
AI1 – AI3 to B1 – B3	L	—	H	X	L	X	L	L	L	Z	H**
	H	—	H	X	L	X	L	L	L	Z	L
	L	—	H	X	L	X	H	H	H	L	H**
	H	—	H	X	L	X	H	H	H	H	L
AI4 – AI6 to B4 – B6	L	—	H	X	X	L	L	L	L	Z	H**
	H	—	H	X	X	L	L	L	L	Z	L
	L	—	H	X	X	L	H	H	H	L	H**
	H	—	H	X	X	L	H	H	H	H	L
Disable Bn outputs	X	X	L	X	X	X	X	X	X	X	H**
	X	X	X	H	H	H	X	X	X	X	H**
Disable B0 outputs	X	X	H	H	X	X	X	X	X	X	H**
Disable B1 – B3 outputs	X	X	H	X	H	X	X	X	X	X	H**
Disable B4 – B6 outputs	X	X	H	X	X	H	X	X	X	X	H**
Bn to AOn	X	L	L	X	X	X	H	H	H	H	Input
	X	H	L	X	X	X	H	H	H	L	Input
	X	L	X	H	H	H	H	H	H	H	Input
	X	H	X	H	H	H	H	H	H	L	Input
B0 to AO0	X	L	L	X	X	X	H	X	X	H	Input
	X	H	L	X	X	X	H	X	X	L	Input
	X	L	X	H	H	H	H	X	X	H	Input
	X	H	X	H	H	H	H	X	X	L	Input
B1 – B3 to AO1 – AO3	X	L	L	X	X	X	X	H	X	H	Input
	X	H	L	X	X	X	X	H	X	L	Input
	X	L	X	H	H	H	X	H	X	H	Input
	X	H	X	H	H	H	X	H	X	L	Input
B4 – B6 to AO4 – AO6	X	L	L	X	X	X	X	X	H	H	Input
	X	H	L	X	X	X	X	X	H	L	Input
	X	L	X	H	H	H	X	X	H	H	Input
	X	H	X	H	H	H	X	X	H	L	Input
Disable AOn outputs	X	X	X	X	X	X	L	L	L	Z	X
Disable AO0 outputs	X	X	X	X	X	X	L	X	X	Z	X
Disable AO1 – AO3 outputs	X	X	X	X	X	X	X	L	X	Z	X
Disable AO4 – AO6 outputs	X	X	X	X	X	X	X	X	L	Z	X

NOTES:

H = High voltage level

L = Low voltage level

X = Don't care

Z = High-impedance (OFF) state

— = Input not externally driven

H** = Goes to level of pull-up voltage

B* = Precaution should be taken to ensure B inputs do not float. If they do, they are equal to Low state.

3.3V BTL 7-bit Futurebus+ transceiver (standard A-port)

FBL2041
FBL2041I

LOGIC DIAGRAM

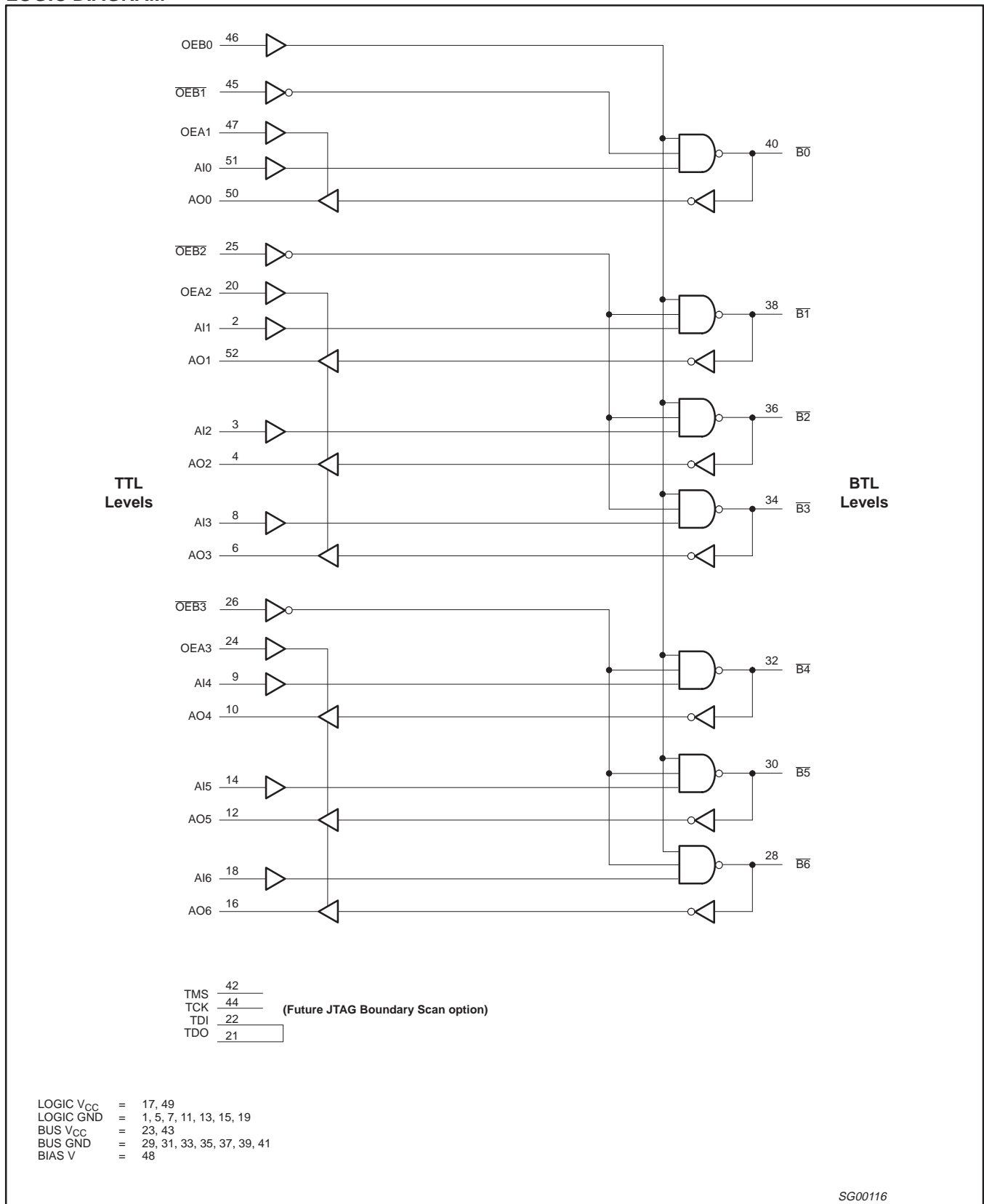

3.3V BTL 7-bit Futurebus+ transceiver (standard A-port)

FBL2041
FBL2041I**ABSOLUTE MAXIMUM RATINGS**

Operation beyond the limits set forth in this table may impair the useful life of the device.
Unless otherwise noted these limits are over the operating free-air temperature range.

SYMBOL	PARAMETER		RATING	UNIT
V_{CC}	Supply voltage		-0.5 to +4.6	V
V_{IN}	Input voltage	A10 – A16, OEBO, \overline{OEBn} , OEAn	-0.5 to +7.0	V
		$\overline{B0} - \overline{B6}$	-0.5 to +3.5	
I_{IN}	Input current	$V_{IN} < 0$	-50	
V_{OUT}	Voltage applied to output in High output state		-0.5 to +7.0	V
I_{OUT}	Current applied to output in Low output state/High output state	A00 – A06	64, -64	mA
		$\overline{B0} - \overline{B6}$	200	
T_{STG}	Storage temperature		-65 to +150	°C

RECOMMENDED OPERATING CONDITIONS

SYMBOL	PARAMETER	COMMERCIAL LIMITS $V_{CC} = 3.3V \pm 10\%$; $T_{amb} = 0$ to $+70^\circ C$			INDUSTRIAL LIMITS $V_{CC} = 3.3V \pm 10\%$; $T_{amb} = -40$ to $+85^\circ C$			UNIT
		MIN	TYP	MAX	MIN	TYP	MAX	
V_{CC}	Supply voltage	3.0	3.3	3.6	3.0	3.3	3.6	V
V_{IH}	High-level input voltage	Except $\overline{B0} - \overline{B6}$	2.0		2.0			V
		$\overline{B0} - \overline{B6}$	1.62	1.55	1.62	1.55		
V_{IL}	Low-level input voltage	Except $\overline{B0} - \overline{B6}$					0.8	V
		$\overline{B0} - \overline{B6}$					1.47	
I_{IK}	Input clamp current			-18			-18	mA
I_{OH}	High-level output current	A00 – A06		-32			-32	mA
I_{OL}	Low-level output current	A00 – A06		+32			+32	mA
		$\overline{B0} - \overline{B6}$		100			100	
C_{OB}	Output capacitance on B port		6	7		6	7	pF
T_{amb}	Operating free-air temperature range	0		+70	-40		+85	°C

LIVE INSERTION SPECIFICATIONS

SYMBOL	PARAMETER	LIMITS			UNIT
		MIN	TYP	MAX	
V_{BIASV}	Bias pin voltage	Voltage difference between the Bias voltage and V_{CC} after the PCB is plugged in.		0.5	V
I_{BIASV}	Bias pin (I_{BIASV}) input DC current	$V_{CC} = 0$ V, Bias $V = 3.6$ V		1.2	mA
		$V_{CC} = 3.3$ V, Bias $V = 3.6$ V		10	μ A
$\overline{V_{Bn}}$	Bus voltage during prebias	$\overline{B0} - \overline{B8} = 0$ V, Bias $V = 3.3$ V		2.1	V
I_{LM}	Fall current during prebias	$\overline{B0} - \overline{B8} = 2$ V, Bias $V = 1.3$ to 2.5 V		1	μ A
I_{HM}	Rise current during prebias	$\overline{B0} - \overline{B8} = 1$ V, Bias $V = 3$ to 3.6 V		-1	μ A
$\overline{I_{BnPEAK}}$	Peak bus current during insertion	$V_{CC} = 0$ to 3.3 V, $\overline{B0} - \overline{B8} = 0$ to 2.0 V, Bias $V = 2.7$ to 3.6 V, OEBO = 0.8 V, $t_r = 2$ ns		10	mA
I_{OLOFF}	Power up current	$V_{CC} = 0$ to 3.3 V, OEBO = 0.8 V		100	μ A
		$V_{CC} = 0$ to 1.2 V, OEBO = 0 to 5 V		100	
t_{GR}	Input glitch rejection	$V_{CC} = 3.3$ V		1.0	ns

3.3V BTL 7-bit Futurebus+ transceiver (standard A-port)

FBL2041
FBL2041I**DC ELECTRICAL CHARACTERISTICS**

Over recommended operating free-air temperature range unless otherwise noted.

SYMBOL	PARAMETER		TEST CONDITIONS ¹	LIMITS			UNIT
				MIN	TYP ²	MAX	
I_{OH}	High level output current	$\overline{B0} - \overline{B6}$	$V_{CC} = \text{MAX}, V_{IL} = \text{MAX}, V_{OH} = 1.9\text{V}$			100	μA
I_{OFF}	Power-off output current	$\overline{B0} - \overline{B6}$	$V_{CC} = 0\text{V}, V_{IL} = \text{MAX}, V_{OH} = 1.9\text{V}$			100	μA
			$V_{CC} = 0\text{V}, V_{IL} = \text{MAX}, V_{OH} = 1.9\text{V} @ 85^\circ\text{C}$			300	μA
V_{OH}	High-level output voltage	AO0 – AO6 ³	$V_{CC} = \text{MIN to MAX}; I_{OH} = -100\mu\text{A}$	$V_{CC} - 0.2$			V
			$V_{CC} = \text{MIN}; I_{OH} = -8\text{mA}$	2.4			V
			$V_{CC} = \text{MIN}; I_{OH} = -32\text{mA}$	2.0			V
V_{OL}	Low-level output voltage	AO0 – AO6 ³	$V_{CC} = \text{MIN}; I_{OL} = 16\text{mA}$			0.4	V
			$V_{CC} = \text{MIN}; I_{OL} = 32\text{mA}$			0.5	V
		$\overline{B0} - \overline{B6}$	$V_{CC} = \text{MIN}, I_{OL} = 4\text{mA}$	0.5			V
			$V_{CC} = \text{MIN}, I_{OL} = 100\text{mA}$	0.75	1.0	1.20	V
V_{IK}	Input clamp voltage		$V_{CC} = \text{MIN}, I_I = I_{IK} = -18\text{mA}$		-0.85	-1.2	V
I_I	Input leakage current	Control pins	$V_{CC} = 3.6\text{V}; V_I = V_{CC} \text{ or GND}$			± 1.0	μA
		Control/ AI0 – AI6	$V_{CC} = 0\text{V or } 3.6\text{V}; V_I = 5.5\text{V}$			10	
		AI0 – AI6	$V_{CC} = 3.6\text{V}; V_I = V_{CC}$			1	
		Note 4	$V_{CC} = 3.6\text{V}; V_I = 0\text{V}$			-5	
I_{IH}	High-level input current	$\overline{B0} - \overline{B6}$	$V_{CC} = \text{MAX}, V_I = 1.9\text{V}$			100	μA
			$V_{CC} = \text{MAX}, V_I = 3.5\text{V}, \text{note } 5$	100			mA
			$V_{CC} = \text{MAX}; V_I = 3.75\text{V} @ -40^\circ\text{C}$	100			mA
I_{IL}	Low-level input current	$\overline{B0} - \overline{B6}$	$V_{CC} = \text{MAX}, V_I = 0.75\text{V}$			-100	μA
I_{OZH}	Off-state output current	AO0 – AO6	$V_{CC} = \text{MAX}, V_O = 3\text{V}$			5	μA
I_{OZL}	Off-state output current	AO0 – AO6	$V_{CC} = \text{MAX}, V_O = 0.5\text{V}$			-5	μA
I_{CC}	Supply current (total)	I_{CCZ}	$V_{CC} = \text{MAX}$		5.2	13.5	mA
		I_{CCB}	$V_{CC} = \text{MAX}, \text{outputs Low or High}$		3.2	9.0	
		I_{CCL}	$V_{CC} = \text{MAX}, \text{outputs Low}$		13.5	19.5	
		I_{CCH}	$V_{CC} = \text{MAX}, \text{outputs High}$		10.7	16.0	

NOTES:

- For conditions shown as MIN or MAX, use the appropriate value specified under recommended operation conditions for the applicable type.
- All typical values are at $V_{CC} = 3.3\text{V}, T_A = 25^\circ\text{C}$.
- Due to test equipment limitations, actual test conditions are $V_{IH} = 1.8\text{V}$ and $V_{IL} = 1.3\text{V}$ for the B side.
- Unused pins are at V_{CC} or GND.
- For B port input voltage between 3 and 5 volt; I_{IH} will be greater than 100mA but the part will continue to function normally (clamping circuit is active).

3.3V BTL 7-bit Futurebus+ transceiver (standard A-port)

FBL2041
FBL2041I

AC ELECTRICAL CHARACTERISTICS

SYMBOL	PARAMETER	TEST CONDITION	A PORT LIMITS								UNIT
			T _{amb} = +25°C, V _{CC} = 3.3V, C _L = 50pf, R _L = 500Ω			FBL2041 COMMERCIAL		FBL2041I INDUSTRIAL			
			T _{amb} = 0 to +70°C, V _{CC} = 3.3V±10%, C _L = 50pF, R _L = 500Ω			T _{amb} = -40 to +85°C, V _{CC} = 3.3V±10%, C _L = 50pF, R _L = 500Ω					
			MIN	TYP	MAX	MIN	MAX	MIN	MAX	MIN	
t _{PLH} t _{PHL}	Propagation delay, B _n to AOn	Waveform 1, 2	3.9 4.0	4.8 4.9	5.8 6.0	3.7 3.8	6.4 6.7	2.8 2.7	6.9 7.0	ns	
t _{PZH} t _{PZL}	Output enable time, OEA to AOn	Waveform 4, 5	5.3 2.4	6.6 4.4	8.0 8.0	5.0 2.1	8.6 8.5	4.5 1.1	9.0 9.0	ns	
t _{PHZ} t _{PLZ}	Output disable time, OEA to AOn	Waveform 4, 5	3.5 2.3	4.8 3.1	6.0 3.9	3.4 2.2	6.5 4.3	2.7 1.4	7.0 4.7	ns	
t _{TLH} t _{THL}	Transition time, AOn Port (10% to 90% or 90% to 10%)	Test Circuit and Waveforms	0.7 0.5	1.8 1.6	3.0 2.0	0.7 0.5	3.0 2.0	0.7 0.5	3.0 2.0	ns	
t _{SK(o)}	Output skew between receivers in same package ¹	Waveform 3		0.7	1.5		1.5		1.5	ns	
SYMBOL	PARAMETER	TEST CONDITION	B PORT LIMITS								UNIT
			T _{amb} = +25°C, V _{CC} = 3.3V, C _D = 30pF, R _U = 9Ω			T _{amb} = 0 to +70°C, V _{CC} = 3.3V±10%, C _D = 30pF, R _U = 9Ω		T _{amb} = -40 to +85°C, V _{CC} = 3.3V±10%, C _D = 30pF, R _U = 9Ω			
			MIN	TYP	MAX	MIN	MAX	MIN	MAX	MIN	
t _{PLH} t _{PHL}	Propagation delay, AIn to B _n	Waveform 1, 2	3.3 2.7	4.2 3.5	5.2 4.5	2.9 2.5	6.0 5.0	1.8 1.7	6.7 5.6	ns	
t _{PLH} t _{PHL}	Enable/disable time, OEB0 to B _n	Waveform 2	4.0 3.4	4.9 4.3	5.8 5.3	3.6 3.1	6.6 6.0	2.8 2.5	7.1 6.4	ns	
t _{PLH} t _{PHL}	Enable/disable time, OEB1 to B _n	Waveform 1	4.2 2.9	5.1 3.8	6.1 4.7	3.9 2.6	6.9 5.5	2.9 1.9	7.3 6.0	ns	
t _{TLH} t _{THL}	Transition time, B _n Port (1.3V to 1.8V)	Test Circuit and Waveforms	1.2 0.4	2.4 0.9	3.0 1.5	1.2 0.4	3.0 1.5	1.2 0.4	3.0 1.5	ns	
t _{SK(o)}	Output skew between drivers in same package ¹	Waveform 3			1.5		1.5		1.5	ns	
SYMBOL	PARAMETER	TEST CONDITION	R _U = 16.5Ω		R _U = 16.5Ω		R _U = 16.5Ω		UNIT		
			MIN	TYP	MIN	MAX	MIN	MAX		MIN	MAX
t _{PLH} t _{PHL}	Propagation delay, AIn to B _n	Waveform 1, 2	3.3 2.7	4.2 3.6	5.1 4.5	3.0 2.5	6.0 5.0	1.8 1.7	6.7 5.6	ns	
t _{PLH} t _{PHL}	Enable/disable time, OEB0 to B _n	Waveform 2	4.0 3.4	4.9 4.3	5.8 5.3	3.6 3.1	6.6 6.0	2.7 2.5	7.1 6.4	ns	
t _{PLH} t _{PHL}	Enable/disable time, OEB1 to B _n	Waveform 1	4.2 2.9	5.1 3.8	6.1 4.7	3.9 2.6	6.8 5.5	3.0 1.9	7.3 6.0	ns	
t _{TLH} t _{THL}	Transition time, B _n Port (1.3V to 1.8V)	Test Circuit and Waveforms	1.2 0.4	2.4 0.9	3.0 1.5	1.2 0.4	3.0 1.5	1.2 0.4	3.0 1.5	ns	
t _{SK(o)}	Output skew between drivers in same package ¹	Waveform 3			1.5		1.5		1.5	ns	

NOTES:

1. |t_{PN}actual - t_{PM}actual| for any data input to output path compared to any other data input to output path where N and M are either LH or HL. Skew times are valid only under same test conditions (temperature, V_{CC}, loading, etc.).

3.3V BTL 7-bit Futurebus+ transceiver (standard A-port)

FBL2041
FBL2041I

AC WAVEFORMS

$V_M = 1.55V$ for \overline{Bn} , $V_M = 1.5V$ for all others.

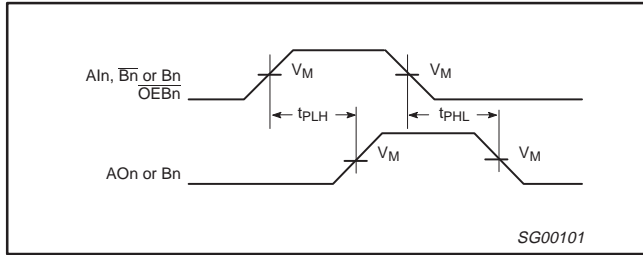

Waveform 1. Propagation Delay for Data or Output Enable to Output

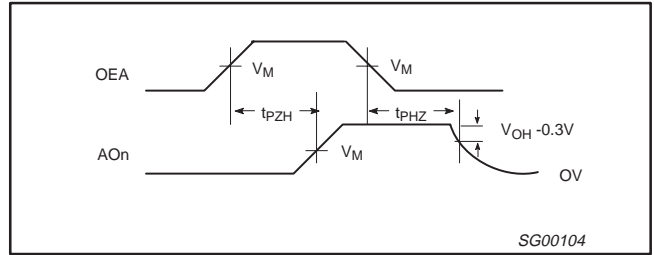

Waveform 4. 3-State Output Enable Time to High Level and Output Disable Time from High Level

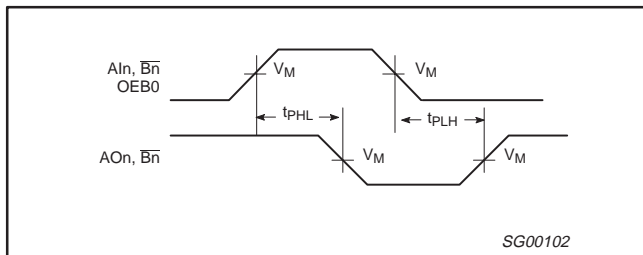

Waveform 2. Propagation Delay for Data or Output Enable to Output

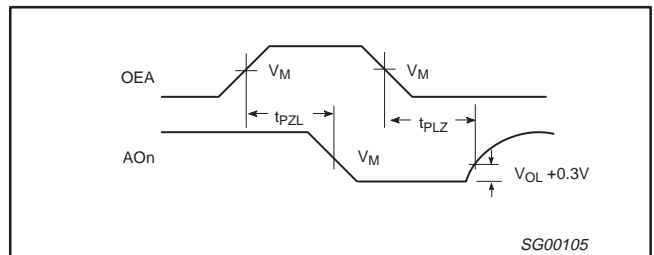

Waveform 5. 3-State Output Enable Time to Low Level and Output Disable Time from Low Level

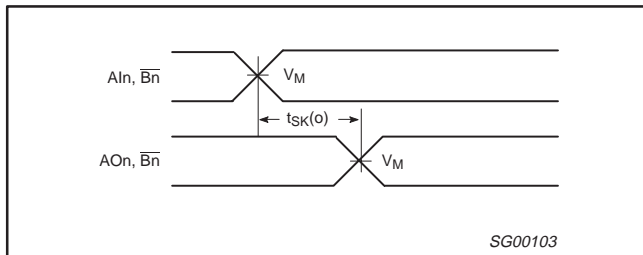

Waveform 3. Output Skews

3.3V BTL 7-bit Futurebus+ transceiver (standard A-port)

FBL2041
FBL2041I

TEST CIRCUIT AND WAVEFORMS

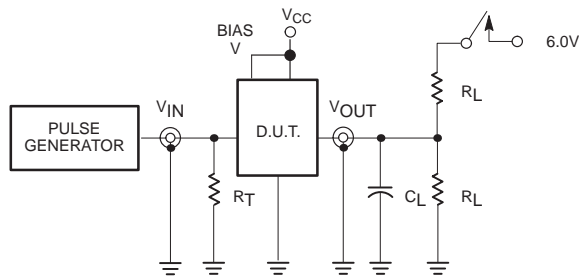

Test Circuit for 3-State Outputs on A Port

SWITCH POSITION FOR ALL A-PORTS

TEST	SWITCH
t_{PLH} , t_{PHL}	OPEN
t_{PLZ} , t_{PZL}	CLOSED
t_{PHZ} , t_{PZH}	GND

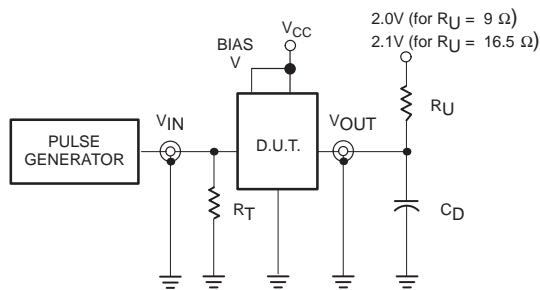

Test Circuit for Outputs on B Port

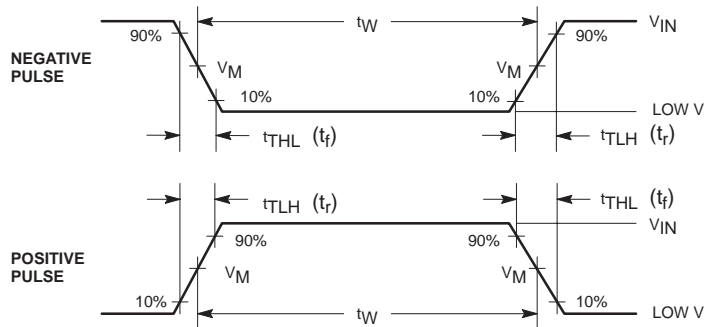

$V_M = 1.55V$ for \overline{Bn} , $V_M = 1.5V$ for all others.

Input Pulse Definitions

Family FB+	INPUT PULSE REQUIREMENTS					
	Amplitude	Low V	Rep. Rate	t_W	t_{TLH}	t_{THL}
A Port	3.0V	0.0V	1MHz	500ns	2.5ns	2.5ns
B Port	2.0V	1.0V	1MHz	500ns	2.5ns	2.5ns

DEFINITIONS:

- R_L = Load Resistor; see AC CHARACTERISTICS for value.
- C_L = Load capacitance includes jig and probe capacitance; see AC CHARACTERISTICS for value.
- R_T = Termination resistance should be equal to Z_{OUT} of pulse generators.
- C_D = Load capacitance includes jig and probe capacitance; see AC CHARACTERISTICS for value.
- R_U = Pull up resistor; see AC CHARACTERISTICS for value.

SG00090

3.3V BTL 7-bit Futurebus+ transceiver (standard A port)

FBL2041
FBL2041I

QFP52: plastic quad flat package; 52 leads (lead length 1.6 mm); body 10 x 10 x 2.0 mm

SOT379-1

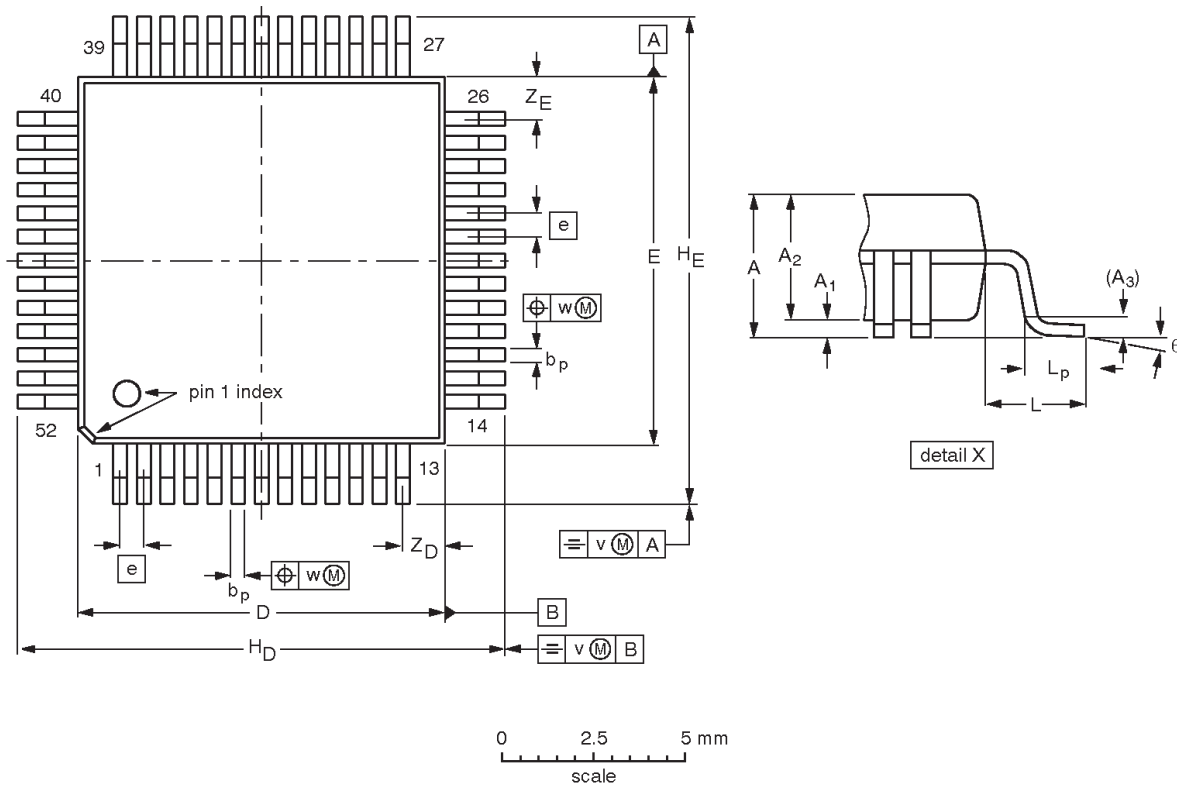
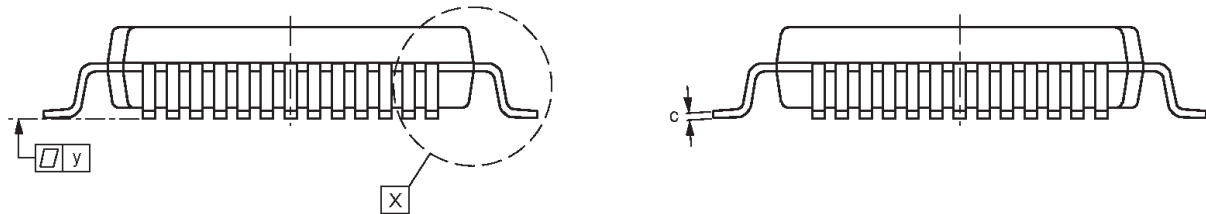

DIMENSIONS (mm are the original dimensions)

UNIT	A max.	A ₁	A ₂	A ₃	b _p	c	D ⁽¹⁾	E ⁽¹⁾	e	H _D	H _E	L	L _p	v	w	y	Z _D ⁽¹⁾	Z _E ⁽¹⁾	θ
mm	2.45	0.45 0.25	2.10 1.95	0.25	0.38 0.22	0.23 0.13	10.1 9.9	10.1 9.9	0.65	13.45 12.95	13.45 12.95	1.60	0.95 0.65	0.20	0.12	0.10	1.24 0.95	1.24 0.95	7° 0°

Note

1. Plastic or metal protrusions of 0.25 mm maximum per side are not included.

OUTLINE VERSION	REFERENCES			EUROPEAN PROJECTION	ISSUE DATE
	IEC	JEDEC	EIAJ		
SOT379-1		MO-108			-95-02-04 97-08-04

3.3V BTL 7-bit Futurebus+ transceiver (standard A port)

FBL2041
FBL2041I

Data sheet status

Data sheet status	Product status	Definition [1]
Objective specification	Development	This data sheet contains the design target or goal specifications for product development. Specification may change in any manner without notice.
Preliminary specification	Qualification	This data sheet contains preliminary data, and supplementary data will be published at a later date. Philips Semiconductors reserves the right to make changes at any time without notice in order to improve design and supply the best possible product.
Product specification	Production	This data sheet contains final specifications. Philips Semiconductors reserves the right to make changes at any time without notice in order to improve design and supply the best possible product.

[1] Please consult the most recently issued datasheet before initiating or completing a design.

Definitions

Short-form specification — The data in a short-form specification is extracted from a full data sheet with the same type number and title. For detailed information see the relevant data sheet or data handbook.

Limiting values definition — Limiting values given are in accordance with the Absolute Maximum Rating System (IEC 134). Stress above one or more of the limiting values may cause permanent damage to the device. These are stress ratings only and operation of the device at these or at any other conditions above those given in the Characteristics sections of the specification is not implied. Exposure to limiting values for extended periods may affect device reliability.

Application information — Applications that are described herein for any of these products are for illustrative purposes only. Philips Semiconductors make no representation or warranty that such applications will be suitable for the specified use without further testing or modification.

Disclaimers

Life support — These products are not designed for use in life support appliances, devices or systems where malfunction of these products can reasonably be expected to result in personal injury. Philips Semiconductors customers using or selling these products for use in such applications do so at their own risk and agree to fully indemnify Philips Semiconductors for any damages resulting from such application.

Right to make changes — Philips Semiconductors reserves the right to make changes, without notice, in the products, including circuits, standard cells, and/or software, described or contained herein in order to improve design and/or performance. Philips Semiconductors assumes no responsibility or liability for the use of any of these products, conveys no license or title under any patent, copyright, or mask work right to these products, and makes no representations or warranties that these products are free from patent, copyright, or mask work right infringement, unless otherwise specified.

Philips Semiconductors
811 East Arques Avenue
P.O. Box 3409
Sunnyvale, California 94088-3409
Telephone 800-234-7381

© Copyright Philips Electronics North America Corporation 1999
All rights reserved. Printed in U.S.A.

Date of release: 11-99

Document order number:

9397 750 06597

Let's make things better.