

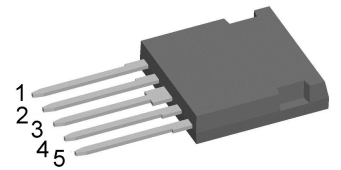
Standard Rectifier

1~ Rectifier	
V_{RRM}	= 1200 V
I_{DAV}	= 40 A
I_{FSM}	= 300 A

1~ Rectifier Bridge

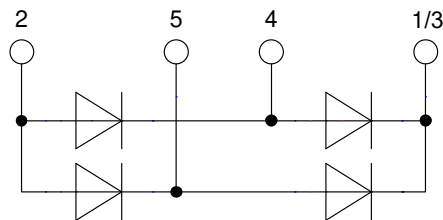
Part number

FBO40-12N



Backside: isolated

 E72873



Features / Advantages:

- Planar passivated chips
- Very low leakage current
- Very low forward voltage drop
- Improved thermal behaviour

Applications:

- Diode Bridge for main rectification

Package: i4-Pac

- Isolation Voltage: 3000 V~
- Industry convenient outline
- RoHS compliant
- Epoxy meets UL 94V-0
- Soldering pins for PCB mounting
- Backside: DCB ceramic
- Reduced weight
- Advanced power cycling

Disclaimer Notice

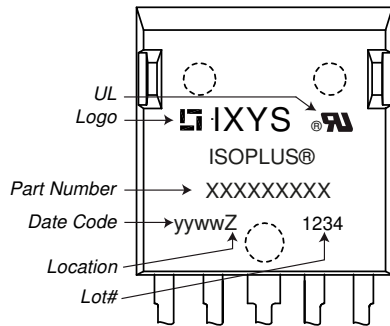
Information furnished is believed to be accurate and reliable. However, users should independently evaluate the suitability of and test each product selected for their own applications. Littelfuse products are not designed for, and may not be used in, all applications. Read complete Disclaimer Notice at www.littelfuse.com/disclaimer-electronics.

Rectifier				Ratings			
Symbol	Definition	Conditions		min.	typ.	max.	Unit
V_{RSM}	max. non-repetitive reverse blocking voltage					1300	V
V_{RRM}	max. repetitive reverse blocking voltage					1200	V
I_R	reverse current	$V_R = 1200$ V	$T_{VJ} = 25^\circ\text{C}$			40	μA
		$V_R = 1200$ V	$T_{VJ} = 150^\circ\text{C}$			1.5	mA
V_F	forward voltage drop	$I_F = 20$ A	$T_{VJ} = 25^\circ\text{C}$			1.17	V
		$I_F = 40$ A				1.38	V
		$I_F = 20$ A	$T_{VJ} = 150^\circ\text{C}$			1.09	V
		$I_F = 40$ A				1.37	V
I_{DAV}	bridge output current	$T_C = 130^\circ\text{C}$ rectangular	$T_{VJ} = 175^\circ\text{C}$ d = 0.5			40	A
V_{FO}	threshold voltage	} for power loss calculation only				0.79	V
r_F	slope resistance					14	m Ω
R_{thJC}	thermal resistance junction to case					1.5	K/W
R_{thCH}	thermal resistance case to heatsink				0.2		K/W
P_{tot}	total power dissipation			$T_C = 25^\circ\text{C}$		100	W
I_{FSM}	max. forward surge current	t = 10 ms; (50 Hz), sine	$T_{VJ} = 45^\circ\text{C}$			300	A
		t = 8,3 ms; (60 Hz), sine	$V_R = 0$ V			325	A
		t = 10 ms; (50 Hz), sine	$T_{VJ} = 150^\circ\text{C}$			255	A
		t = 8,3 ms; (60 Hz), sine	$V_R = 0$ V			275	A
I^2t	value for fusing	t = 10 ms; (50 Hz), sine	$T_{VJ} = 45^\circ\text{C}$			450	A ² s
		t = 8,3 ms; (60 Hz), sine	$V_R = 0$ V			440	A ² s
		t = 10 ms; (50 Hz), sine	$T_{VJ} = 150^\circ\text{C}$			325	A ² s
		t = 8,3 ms; (60 Hz), sine	$V_R = 0$ V			315	A ² s
C_J	junction capacitance	$V_R = 400$ V; f = 1 MHz		$T_{VJ} = 25^\circ\text{C}$		4	pF



Package i4-Pac		Ratings				
Symbol	Definition	Conditions	min.	typ.	max.	Unit
I_{RMS}	RMS current	per terminal			35	A
T_{VJ}	virtual junction temperature		-55		175	°C
T_{op}	operation temperature		-55		150	°C
T_{stg}	storage temperature		-55		150	°C
Weight				6		g
F_C	mounting force with clip		20		120	N
$d_{Spp/ App}$	creepage distance on surface / striking distance through air	terminal to terminal	1.7			mm
$d_{Spb/ Apb}$		terminal to backside	5.1			mm
V_{ISOL}	isolation voltage	t = 1 second	3000			V
		t = 1 minute	2500			V

Product Marking



Ordering	Ordering Number	Marking on Product	Delivery Mode	Quantity	Code No.
Standard	FBO40-12N	FBO40-12N	Tube	25	492256

Equivalent Circuits for Simulation

* on die level

$T_{VJ} = 175^{\circ}C$

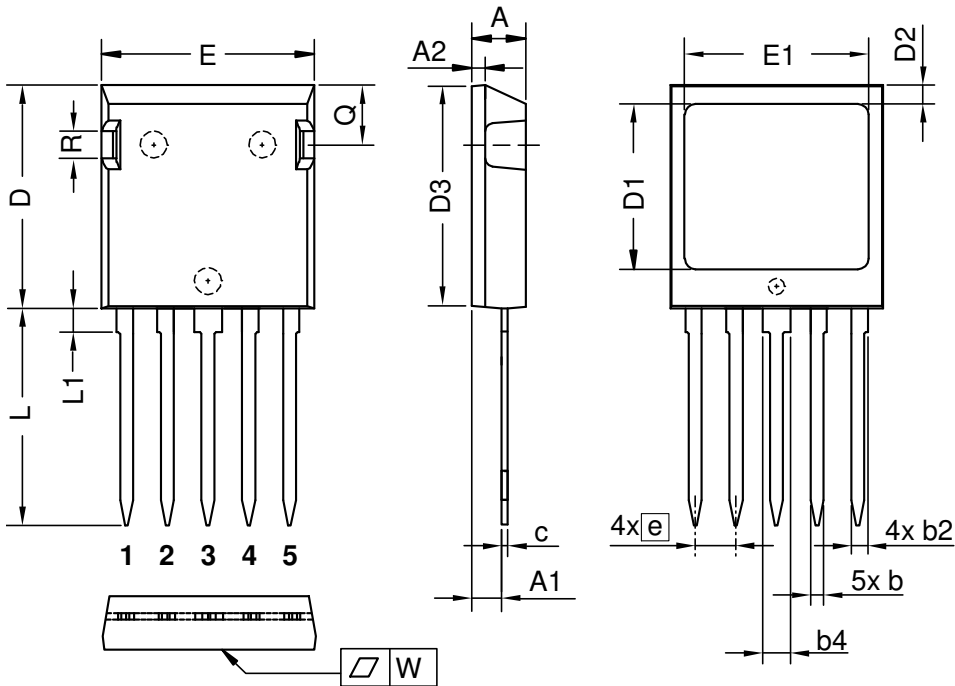


Rectifier

$V_{0\ max}$	threshold voltage	0.79	V
$R_{0\ max}$	slope resistance *	12	mΩ

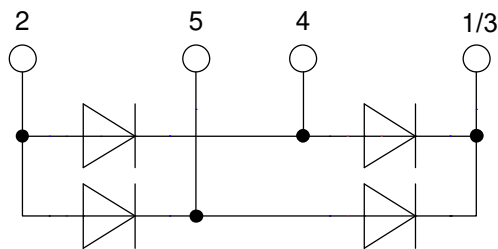


Outlines i4-Pac



Dim.	Millimeter		Inches	
	min	max	min	max
A	4.83	5.21	0.190	0.205
A1	2.59	3.00	0.102	0.118
A2	1.17	2.16	0.046	0.085
b	1.14	1.40	0.045	0.055
b2	1.47	1.73	0.058	0.068
b4	2.54	2.79	0.100	0.110
c	0.51	0.74	0.020	0.029
D	20.80	21.34	0.819	0.840
D1	14.99	15.75	0.590	0.620
D2	1.65	2.03	0.065	0.080
D3	20.30	20.70	0.799	0.815
E	19.56	20.29	0.770	0.799
E1	16.76	17.53	0.660	0.690
e	3.81 BSC		0.150 BSC	
L	19.81	21.34	0.780	0.840
L1	2.11	2.59	0.083	0.102
Q	5.33	6.20	0.210	0.244
R	2.54	4.57	0.100	0.180
W	-	0.10	-	0.004

Die konvexe Form des Substrates ist typ. < 0.05 mm über der Kunststoffoberfläche der Bauteilunterseite
The convexbow of substrate is typ. < 0.05 mm over plastic surface level of device bottom side



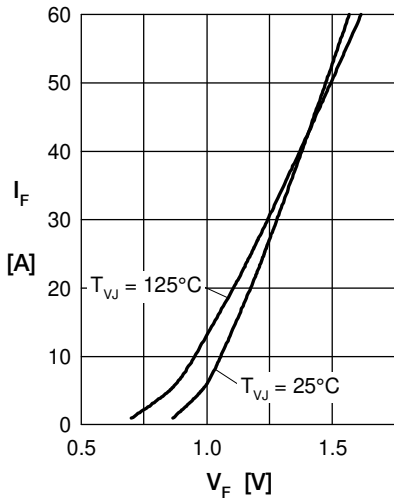
Rectifier


Fig. 1 Forward current versus voltage drop per diode

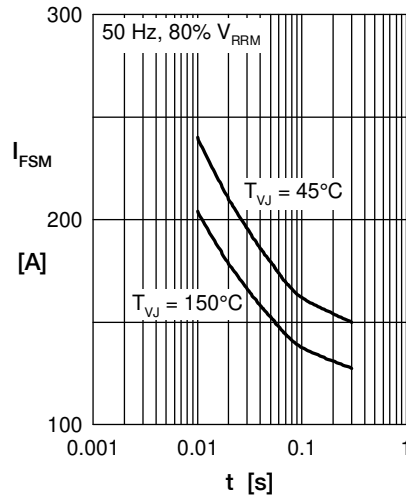


Fig. 2 Surge overload current

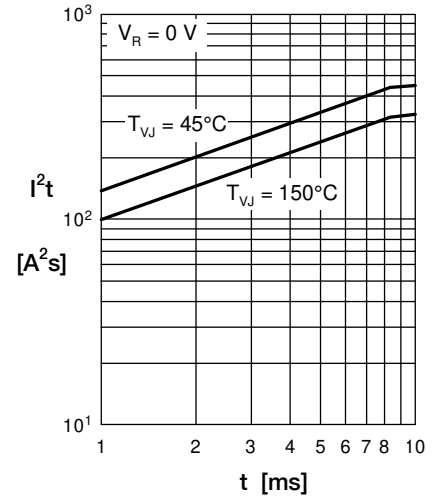
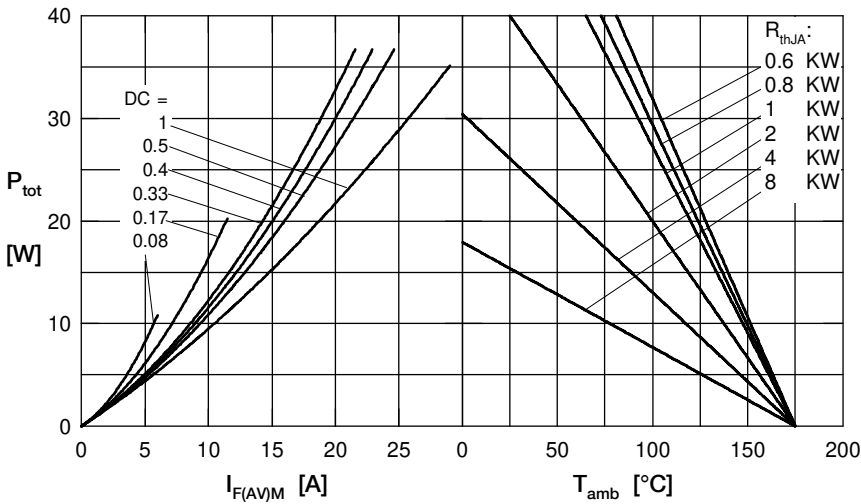

 Fig. 3 I^2t versus time per diode


Fig. 4 Power dissipation vs. direct output current and ambient temperature

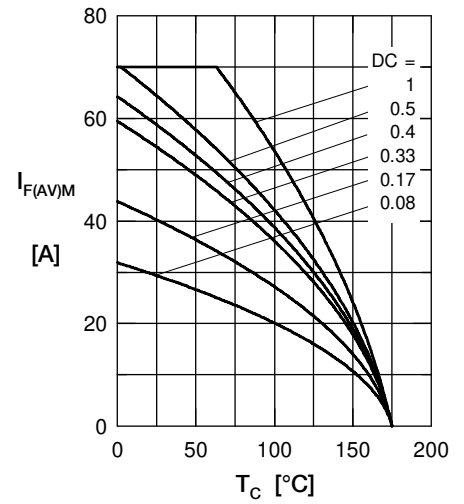


Fig. 5 Max. forward current vs. case temperature

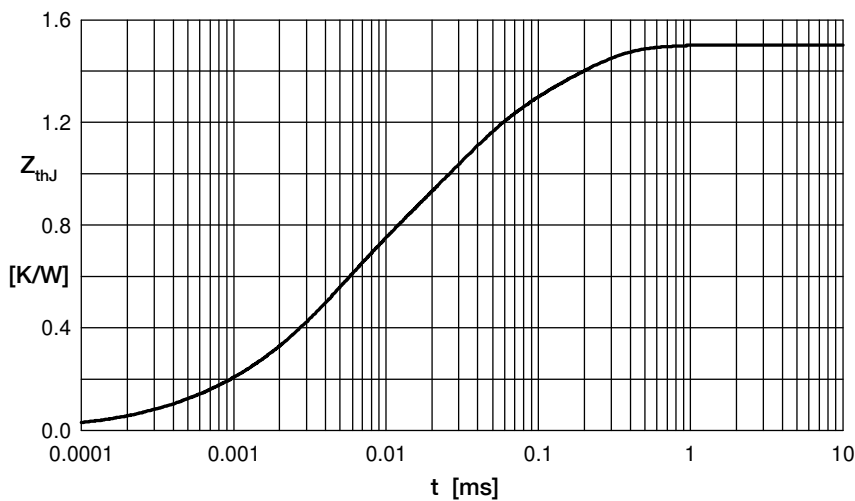


Fig. 6 Transient thermal impedance junction to case

 Constants for Z_{thJC} calculation:

i	R_{thi} (K/W)	t_i (s)
1	0.06075	0.0004
2	0.183	0.00256
3	0.3405	0.0045
4	0.543	0.0242
5	0.3728	0.15