

10 Amp High Voltage SCHOTTKY BARRIER RECTIFIERS

FBR1060...10100 Series

Description



Mechanical Dimensions

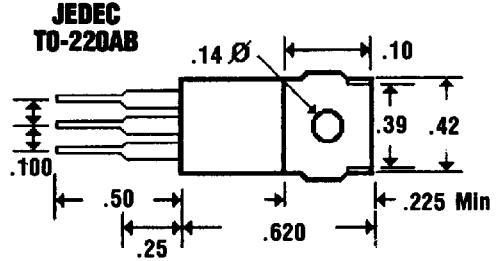

Features

- HIGH CURRENT CAPABILITY WITH LOW V_f
- SUPERIOR METAL PROCESS
- HIGH SURGE VOLTAGE AND TRANSIENT PROTECTION
- MEETS UL SPECIFICATION 94V-0

Electrical Characteristics @ 25°C.	FBR1060 . . . 10100 Series					Units
Maximum Ratings	FBR1060	FBR1070	FBR1080	FBR1090	FBR10100	
Peak Repetitive Reverse Voltage... V_{RRM}	60	70	80	90	100	Volts
Working Peak Reverse Voltage... V_{RWM}	60	70	80	90	100	Volts
DC Blocking Voltage... V_{DC}	60	70	80	90	100	Volts
Average Forward Rectified Current... $I_{F(av)}$ @ $T_c = 104^\circ\text{C}$	10					Amps
Repetitive Peak Forward Surge Current... I_{FM} 20KHZ Square Wave	20					Amps
Non-Repetitive Peak Forward Surge Current... I_{FSM} @ Rated Load Conditions, 8.3mS, 1/2 Sine Wave	150					Amps
Repetitive Peak Reverse Surge Current... I_{RSM}	0.5					Amps
Forward Voltage... V_f @ $I_f = 10$ Amps @ $I_f = 10$ Amps	$T_c = 25^\circ\text{C}$		$T_c = 125^\circ\text{C}$			Volts Volts
DC Reverse Current... I_r @ Rated DC Blocking Voltage	$T_c = 25^\circ\text{C}$		$T_c = 125^\circ\text{C}$			mAmps mAmps
Typical Thermal Resistance... $R_{\theta JC}$	2					$^\circ\text{C} / \text{W}$
Operating Temperature Range... T_j	-65 to 150					$^\circ\text{C}$
Storage Temperature Range... T_{STRG}	-65 to 175					$^\circ\text{C}$

10 Amp High Voltage SCHOTTKY BARRIER RECTIFIERS

FBR1060...10100 Series

Forward Current Derating Curve

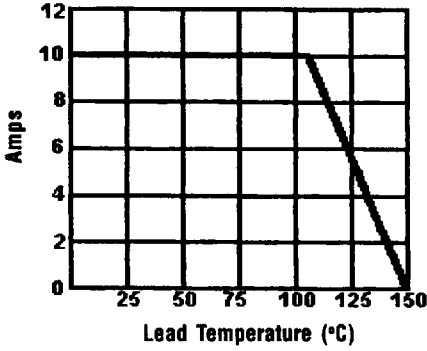

Typical Reverse Characteristics

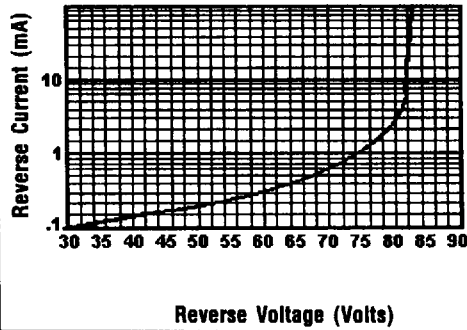

Typical Forward Characteristics

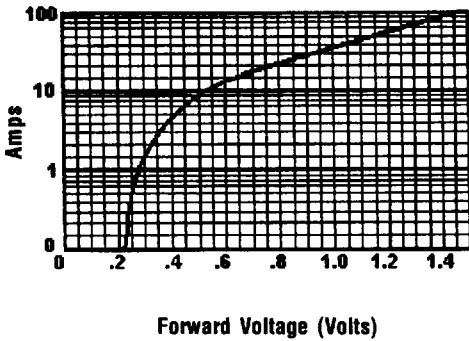

Typical Junction Capacitance

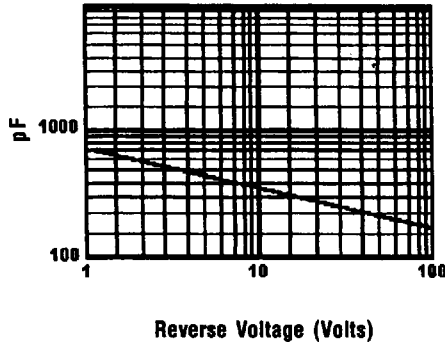

Case Positive, No Suffix Required

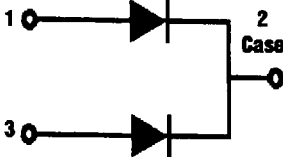

Typical Forward Characteristics

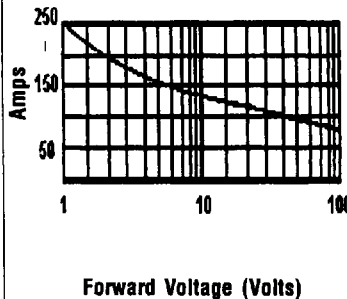

Case Negative, Use Suffix "R"

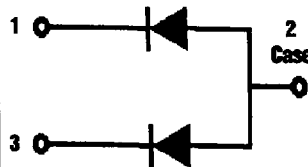

Ratings at 25 Deg. C ambient temperature unless otherwise specified.

Single Phase Half Wave, 60 HZ Resistive or Inductive Load.

For Capacitive Load, Derate Current by 20%.

- NOTES:**
1. Measured @ 1 MHz and applied reverse voltage of 4.0V.
 2. Thermal Resistance Junction to Case, Jedec Method.
 3. When Mounted to heat sink, from body.

Reel Packaging

Package Style	Quantity per Reel	Component Spacing "A" Fig. 1	Approximate Gross Weight Packed Reel	Carton Size	Pcs. Per Carton	Appx. Gross Weight
Axials						
D041	5000	5mm	2.32 KG	34X34X34.5 cm	20,000	10.5KG
D015	4000	5mm	2.25 KG	34X34X34.5 cm	16,000	10.0KG
D0201AD	1200	10mm	2.08 KG	34X34X34.5 cm	4,800	7.3KG
P6	700	10mm	1.55 KG	34X34X34.5 cm	2,800	9.2KG

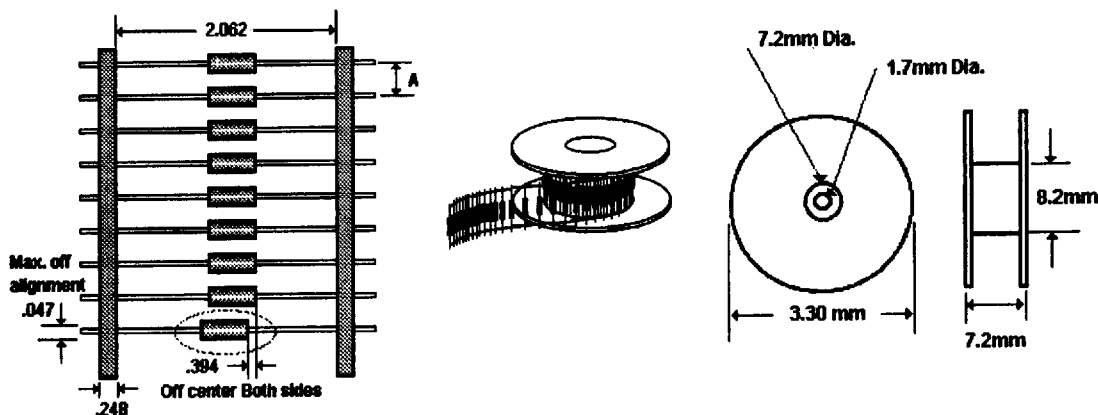

Ammunition Packaging

Package Style	Quantity Pcs / Box	Component Spacing "A" Fig. 1	Box Size	Carton Size	Pcs. Per Carton	Appx. Gross Weight
D041	4000	5mm	26X10X10cm	30X27X22cm	24,000	10KG
D015	2200	5mm	26X10X10cm	30X27X22cm	13,200	10KG
D0201AD	1000	10mm	26X10X10cm	30X27X22cm	6,000	9.4KG
P6	300	10mm	26X10X10cm	30X27X22cm	1,800	7KG

Bulk Packaging

Package Style	Box Size	Pcs. Per Carton	Appx. Gross Weight	Carton Size	Pcs. Per Carton	Appx. Gross Weight
D041	20.3X8.3X2.54cm	1,000	.38KG	46X21.5X25.4cm	50,000	20KG
D015	20.3X8.3X2.54cm	500	.21KG	46X21.5X25.4cm	25,000	12KG
D0201AD	26X10X10cm	500	.68KG	46X21.5X25.4cm	12,500	18KG
P6	26X10X10cm	200	.50KG	46X21.5X25.4cm	5000	13.5KG

Bulk Packaging

Package Style	Box Size	Pcs. Per Carton	Appx. Gross Weight	Carton Size	Pcs. Per Carton	Appx. Gross Weight
1W, W, 2W	21X9X8.8cm	500	Std. .98KG	48X22X36cm	10,000	Std. 21KG
		500	Min. .78KG	48X22X36cm	10,000	Mn. 17KG
MDA	23.5X23.5X5.5cm	400	1.24KG	51X25X30cm	4,000	13.1KG
KBL	23.5X23.5X5.5cm	400	2.36KG	51X25X30cm	4,000	24.3KG
KBU	23.5X23.5X5.5cm	400	2.60KG	51X25X30cm	4,000	26.7KG
KBPC8	23.5X23.5X5.5cm	200	1.30KG	51X25X30cm	2000	13.7KG
KBPC1	21X21X5.5cm	200	.66KG	47X22X27cm	1600	5.9KG
KBPC6	21X21X5.5cm	200	.94KG	47X22X27cm	1600	8.1KG
KBPC10,15,25,35	21X21X5.5cm	50	1.77KG	47X22X27cm	400	14.9KG

SMD Packing

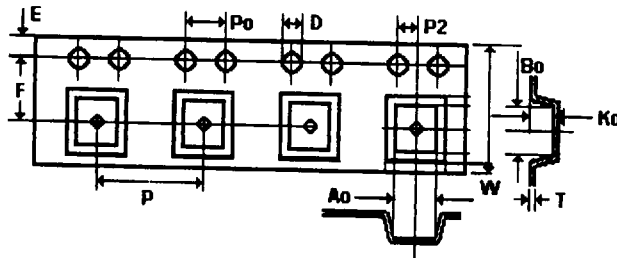

	W	Po	P	P2	D	E	F	Ao	Bo	Ko	T
MM	12	4	8	2	1.5	1.75	3.5	2.8	5.8	2.9	0.3
Inches	0.47	0.16	0.32	0.08	0.06	0.07	0.14	0.11	0.22	0.11	0.01

