



FC12

TR:NPN Epitaxial Planar Silicon Transistor
 FET:N-Channel Junction Silicon Transistor
**High-Frequency Amp, AM Applications,
 Low-Frequency Amp**

Features

- Composite type with 2 transistors contained in the CP package currently in use, improving the mounting efficiency greatly.
- The FC12 is formed with two chips, being equivalent to the 2SC4639, placed in one package.
- Common drain and emitter.

Electrical Connection

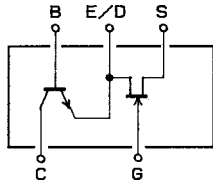

Package Dimensions

unit:mm
2075

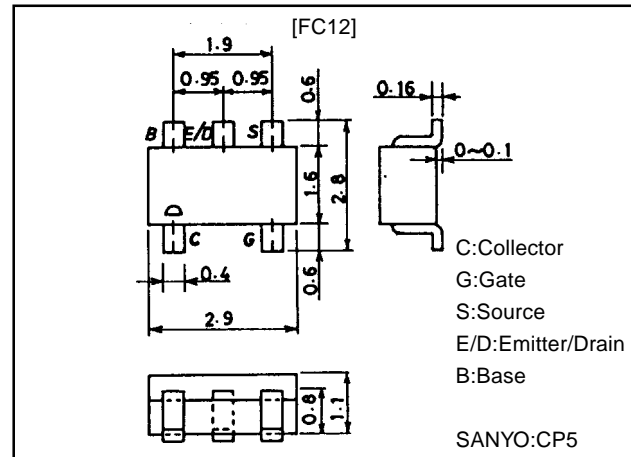

Switching Time Test Circuit

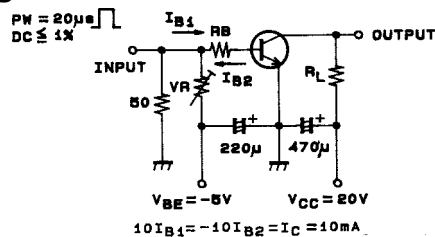

Specifications

Absolute Maximum Ratings at Ta = 25°C

Parameter	Symbol	Conditions	Ratings	Unit
[FET]				
Drain-to-Source Voltage	V_{DSX}		15	V
Gate-to-Drain Voltage	V_{GDS}		-15	V
Gate Current	I_G		10	mA
Drain Current	I_D		50	mA
Allowable Power Dissipation	P_D		200	mW
[TR]				
Collector-to-Base Voltage	V_{CBO}		55	V
Collector-to-Emitter Voltage	V_{CEO}		50	V
Emitter-to-Base Voltage	V_{EBO}		6	V
Collector Current	I_C		150	mA
Collector Current (Pulse)	I_{CP}		300	mA
Base Current	I_B		30	mA
Collector Dissipation	P_C		200	mW
[Common Ratings]				
Total Dissipation	PT		300	mW
Junction Temperature	T_j		150	°C
Storage Temperature	T_{stg}		-55 to +150	°C

Marking:12

SANYO Electric Co.,Ltd. Semiconductor Business Headquarters

TOKYO OFFICE Tokyo Bldg., 1-10, 1 Chome, Ueno, Taito-ku, TOKYO, 110-8534 JAPAN

FC12

Electrical Characteristics at $T_a = 25^\circ\text{C}$

Parameter	Symbol	Conditions	Ratings			Unit
			min	typ	max	
[FET]						
Gate-to-Drain Breakdown Voltage	$V_{(BR)GDS}$	$I_G = -10\mu\text{A}, V_{DS} = 0$	-15			V
Gate-to-Cutoff Current	I_{GSS}	$V_{GS} = -10\text{V}, V_{DS} = 0$			-1.0	nA
Cutoff Voltage	$V_{GS(off)}$	$V_{DS} = 5\text{V}, I_D = 100\mu\text{A}$	-0.2	-0.6	-1.4	V
Drain Current	I_{DSS}	$V_{DS} = 5\text{V}, V_{GS} = 0$	6.0*		20.0*	mA
Forward Transfer Admittance	$ Y_{fs} $	$V_{DS} = 5\text{V}, V_{GS} = 0, f = 1\text{kHz}$	25	50		mS
Input Capacitance	C_{iss}	$V_{DS} = 5\text{V}, V_{GS} = 0, f = 1\text{MHz}$		10		pF
Reverse Transfer Capacitance	C_{rss}	$V_{DS} = 5\text{V}, V_{GS} = 0, f = 1\text{MHz}$		3.0		pF
Noise Figure	NF	$V_{DS} = 5\text{V}, R_g = 1\text{k}\Omega, I_D = 1\text{mA}, f = 1\text{kHz}$		1.5		dB
[TR]						
Collector Cutoff Current	I_{CBO}	$V_{CB} = 35\text{V}, I_E = 0$			0.1	μA
Emitter Cutoff Current	I_{EBO}	$V_{EB} = 4\text{V}, I_C = 0$			0.1	μA
DC Current Gain	h_{FE}	$V_{CE} = 6\text{V}, I_C = 1\text{mA}$	135		400	
Gain-Bandwidth Product	f_T	$V_{CE} = 6\text{V}, I_C = 10\text{mA}$		200		MHz
Output Capacitance	C_{ob}	$V_{CB} = 6\text{V}, f = 1\text{MHz}$		1.7		pF
C-E Saturation Voltage	$V_{CE(sat)}$	$I_C = 50\text{mA}, I_B = 5\text{mA}$		0.08	0.4	V
B-E Saturation Voltage	$V_{BE(sat)}$	$I_C = 50\text{mA}, I_B = 5\text{mA}$		0.8	1.0	V
C-B Breakdown Voltage	$V_{(BR)CBO}$	$I_C = 10\mu\text{A}, I_E = 0$	55			V
C-E Breakdown Voltage	$V_{(BR)CEO}$	$I_C = 1\text{mA}, R_{BE} = \infty$	50			V
E-B Breakdown Voltage	$V_{(BR)EBO}$	$I_E = 10\mu\text{A}, I_C = 0$	6			V
Turn-ON Time	t_{on}	See specified Test Circuit		0.15		μs
Storage Time	t_{stg}	See specified Test Circuit		0.75		μs
Fall Time	t_f	See specified Test Circuit		0.20		μs

Note*: The FC12 is classified by I_{DSS} as follows : (unit: mA).

6.0 F	12.0	10.0 G	20.0
-------	------	--------	------

Primary Characteristics of FET

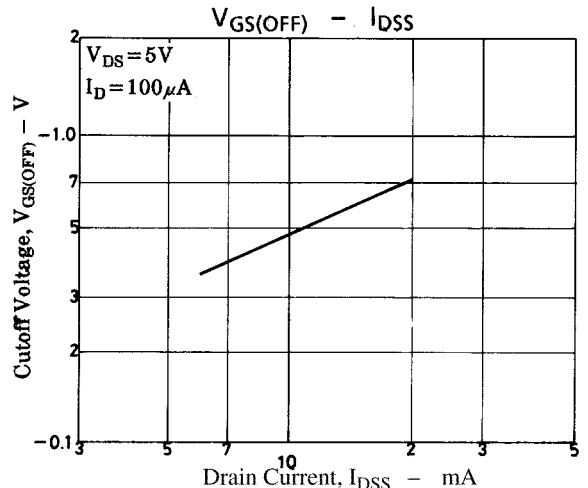
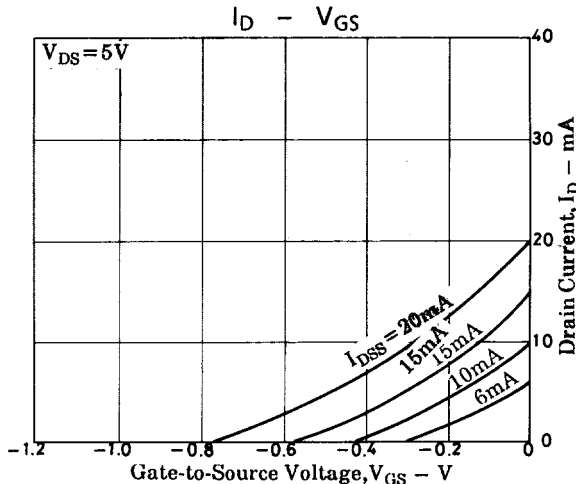
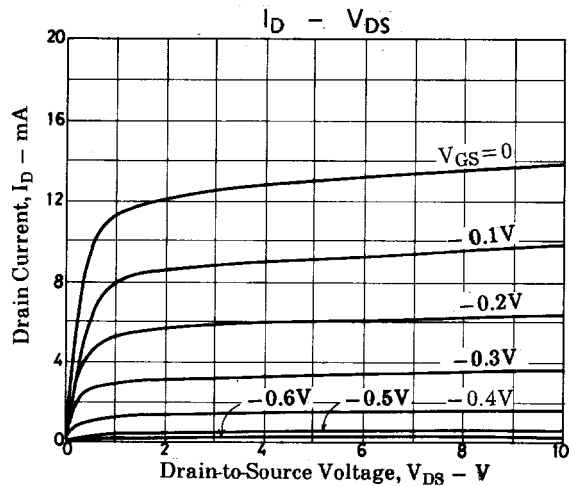
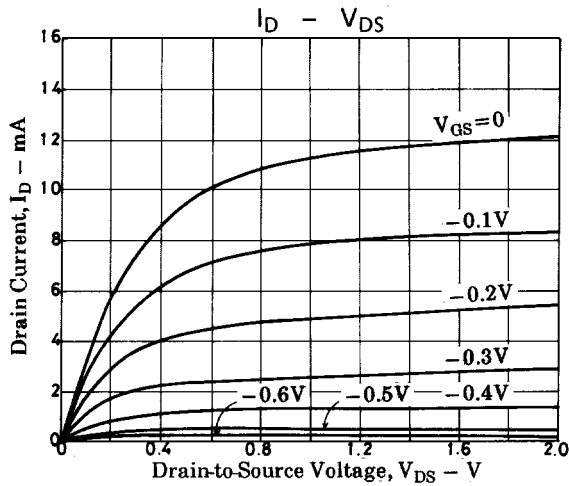

FC12

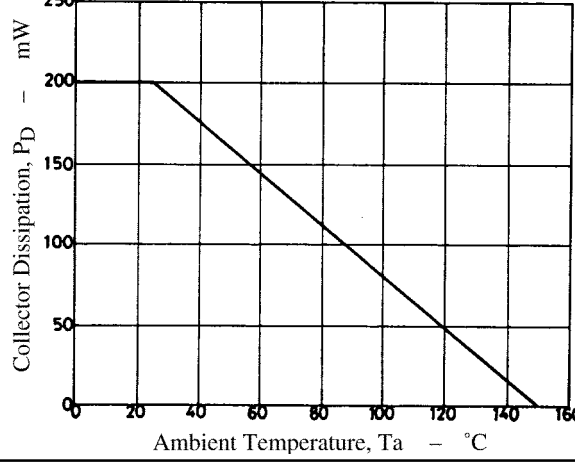
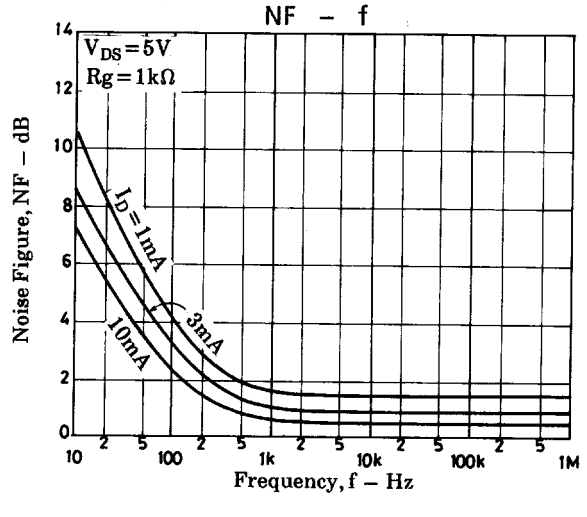
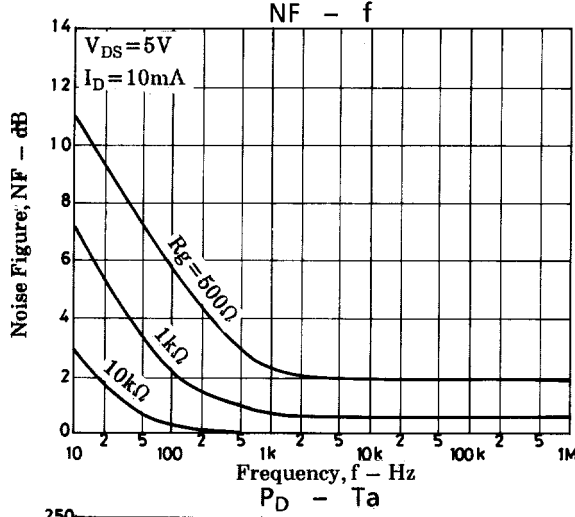
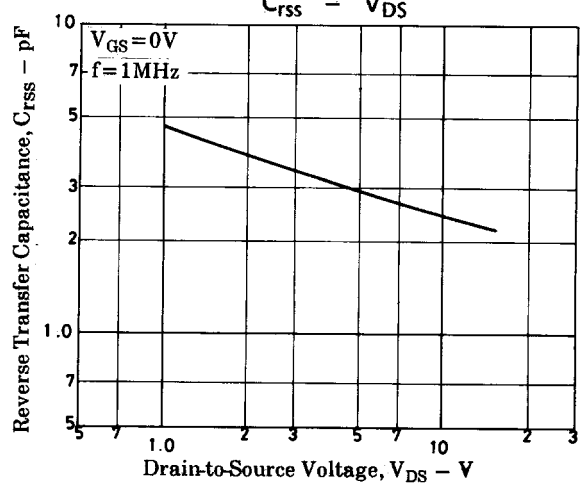
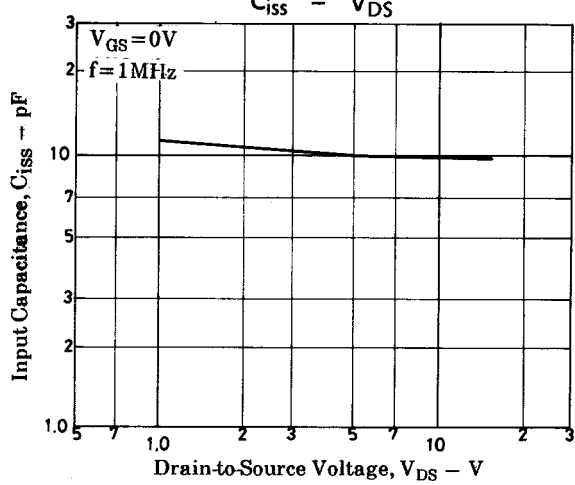
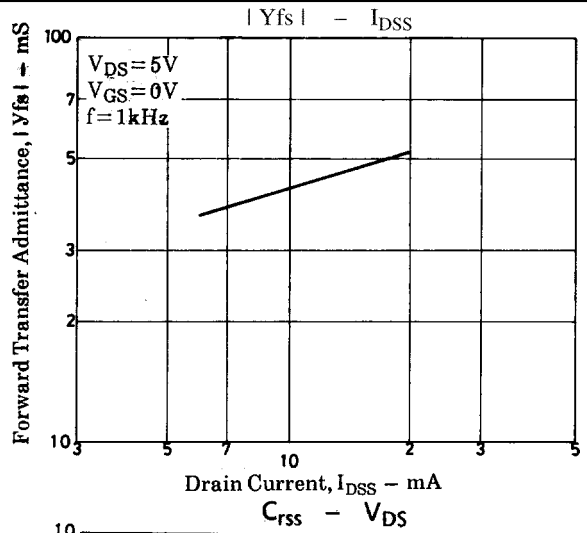
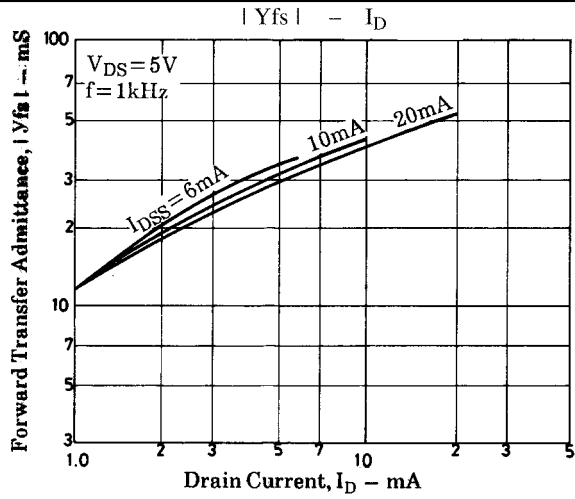

Primary Characteristic of TR

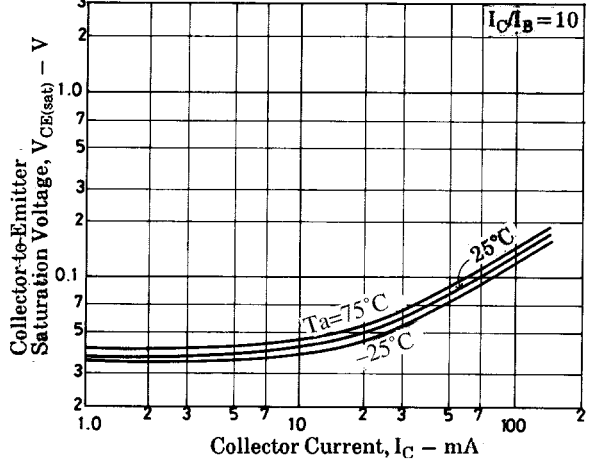
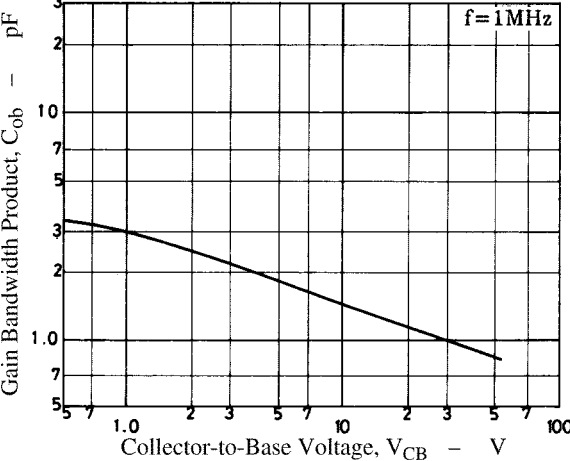
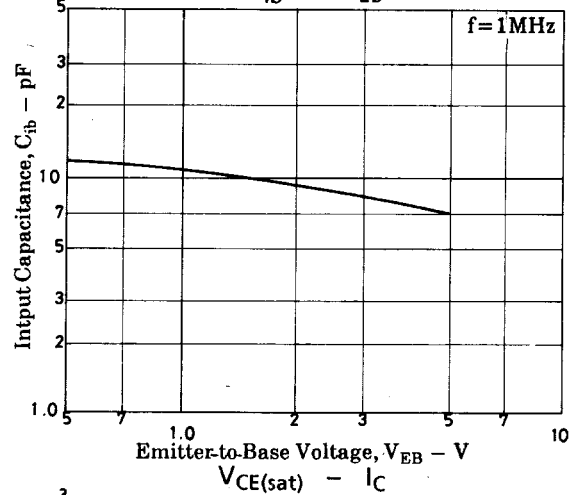
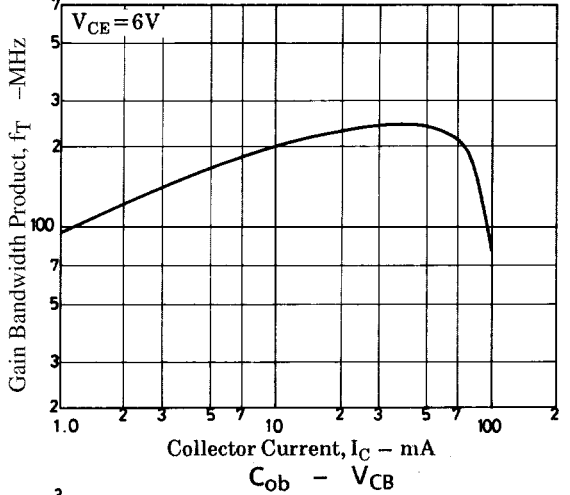
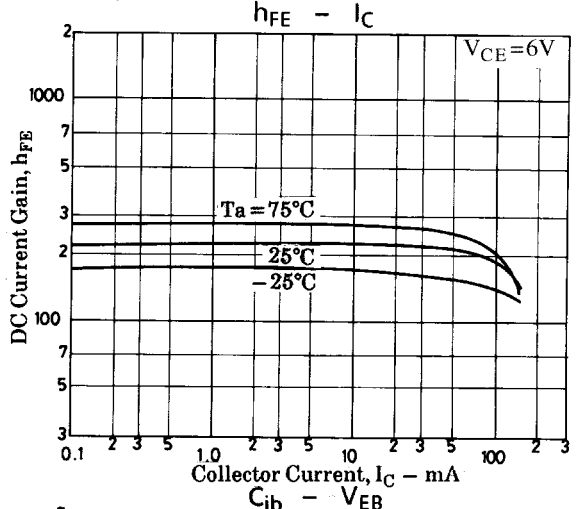
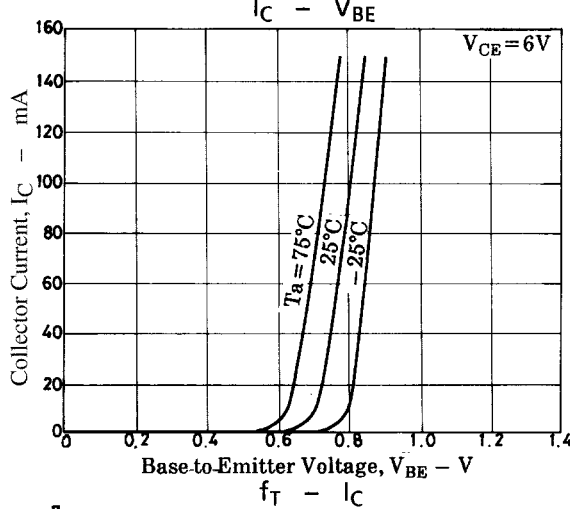
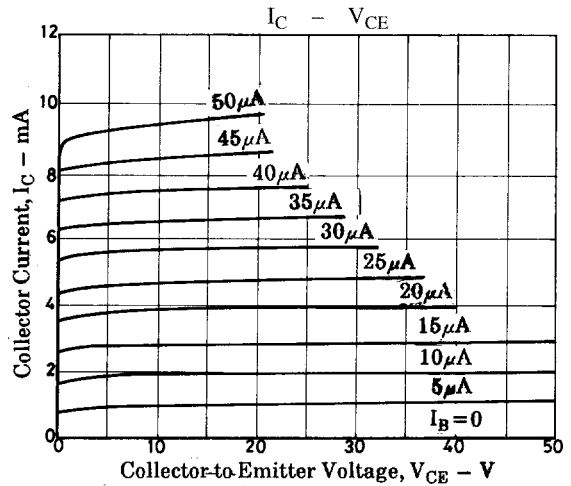
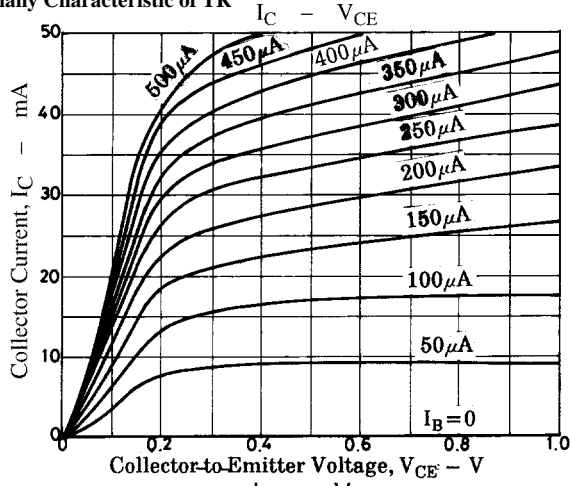

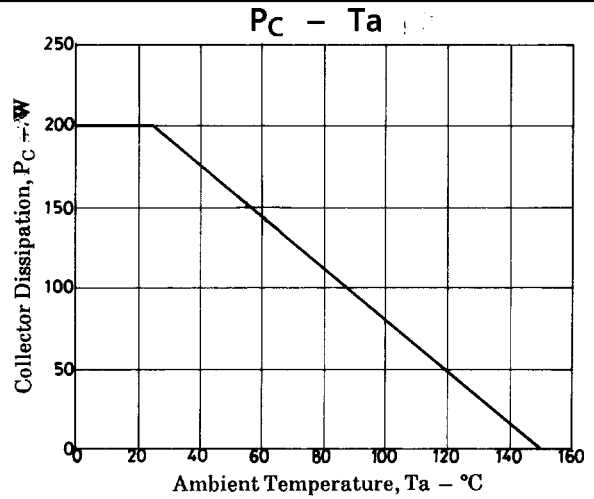
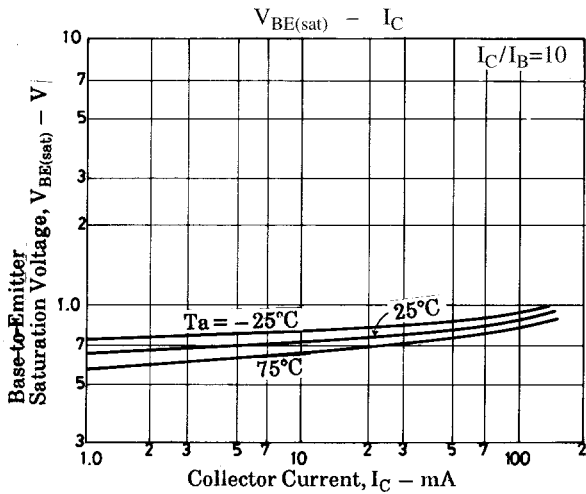

■ No products described or contained herein are intended for use in surgical implants, life-support systems, aerospace equipment, nuclear power control systems, vehicles, disaster/crime-prevention equipment and the like, the failure of which may directly or indirectly cause injury, death or property loss.

■ Anyone purchasing any products described or contained herein for an above-mentioned use shall:

- ① Accept full responsibility and indemnify and defend SANYO ELECTRIC CO., LTD., its affiliates, subsidiaries and distributors and all their officers and employees, jointly and severally, against any and all claims and litigation and all damages, cost and expenses associated with such use:
- ② Not impose any responsibility for any fault or negligence which may be cited in any such claim or litigation on SANYO ELECTRIC CO., LTD., its affiliates, subsidiaries and distributors or any of their officers and employees jointly or severally.

■ Information (including circuit diagrams and circuit parameters) herein is for example only; it is not guaranteed for volume production. SANYO believes information herein is accurate and reliable, but no guarantees are made or implied regarding its use or any infringements of intellectual property rights or other rights of third parties.

This catalog provides information as of May, 1998. Specifications and information herein are subject to change without notice.