

10A Avg.

200 Volts

SBD

FCH10U20

最大定格 Maximum Ratings

Item	Symbol	Conditions	Unit
くり返しピーク逆電圧 Repetitive Peak Reverse Voltage	V_{RRM}	200	V
平均整流電流 Average Rectified Forward Current	I_O	50Hz, 正弦全波通電抵抗負荷 50Hz Full Sine Wave Resistive Load	10 A
実効順電流 R.M.S. Forward Current	$I_F(RMS)$	11.1	A
サーージ順電流 Surge Forward Current	I_{FSM}	100 50Hz正弦全波, 1サイクル, 非くり返し 50Hz Full Sine Wave, 1cycle, Non-repetitive	A
動作接合温度範囲 Operating Junction Temperature Range	T_{jw}	-40~+150	°C
保存温度範囲 Storage Temperature Range	T_{stg}	-40~+150	°C
締付トルク Mounting torque	F_{tor}	推奨値 Recommended Value	0.5 N·m

OUTLINE DRAWING(mm)

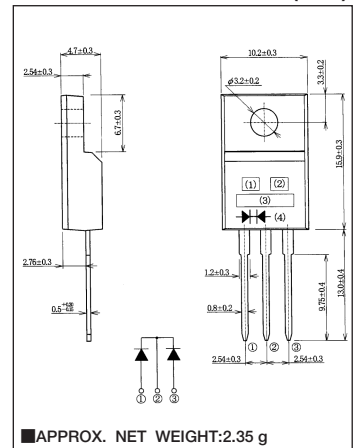

APPROX. NET WEIGHT:2.35 g

電氣的・熱的特性 Electrical/Thermal Characteristics

Item	Symbol	Conditions	Min.	Typ.	Max.	Unit
ピーク逆電流 Peak Reverse Current	I_{RM}	$T_j=25^{\circ}C, V_{RM}=V_{RRM}$, 一素子あたり Per Diode	—	—	200	μA
ピーク順電圧 Peak Forward Voltage	V_{FM}	$T_j=25^{\circ}C, I_{FM}=5A$, 一素子あたり Per Diode	—	—	0.90	V
熱抵抗 Thermal Resistance	$R_{th(j-c)}$	接合部・ケース間 Junction to Case	—	—	3	°C/W
	$R_{th(c-f)}$	ケース・フィン間 Case to Fin	—	—	1.5	°C/W

定格・特性曲線

FIG.1

順電圧特性
FORWARD CURRENT VS. VOLTAGE

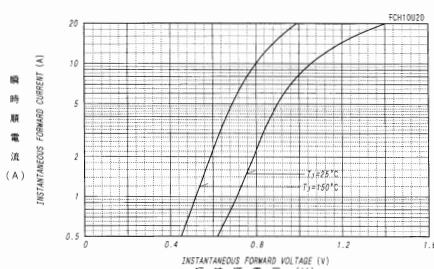

FIG.2

平均順電力損失特性
AVERAGE FORWARD POWER DISSIPATION

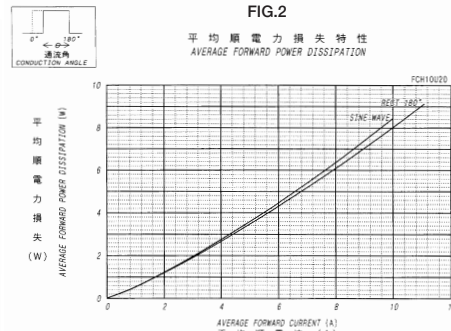

FIG.3

ピーク逆電流 - ピーク逆電圧特性
PEAK REVERSE CURRENT VS. PEAK REVERSE VOLTAGE

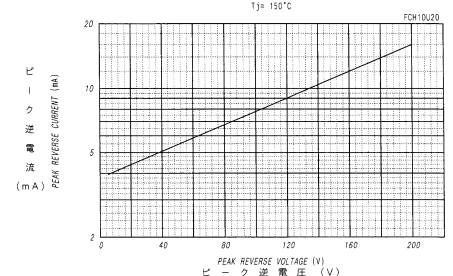

FIG.4

平均逆電力損失
AVERAGE REVERSE POWER DISSIPATION

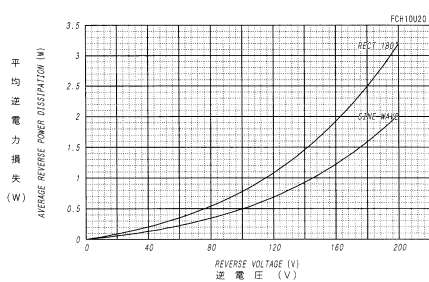

FIG.5

平均順電流 - ケース温度定格
AVERAGE FORWARD CURRENT VS. CASE TEMPERATURE

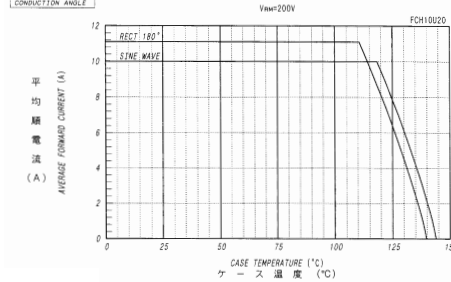

FIG.6

サーージ順電流定格
SURGE CURRENT RATINGS

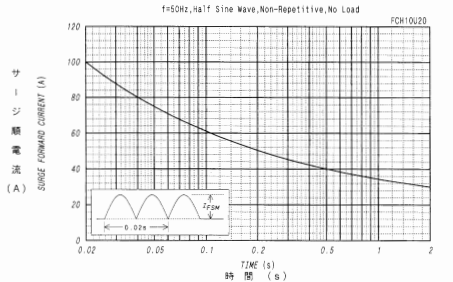

FIG.7

接合容量特性
JUNCTION CAPACITANCE VS. REVERSE VOLTAGE

