

SBD Type : FCH20A06

OUTLINE DRAWING

FEATURES

- *TO-220AB Case
- *Fully Molded
- *Dual Diodes – Cathode Common
- *Low Forward Voltage Drop
- *High Surge Capability
- *Tj=150 °C operation

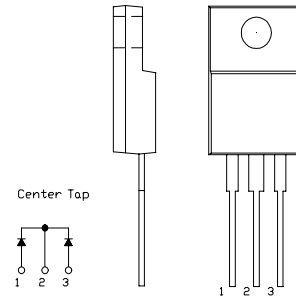

Maximum Ratings

Approx Net Weight: 1.75g

Rating	Symbol	FCH20A06		Unit
Repetitive Peak Reverse Voltage	V_{RRM}	60		V
Repetitive Peak Surge Reverse Voltage	V_{RRSM}	65(pulse width $\leq 1\mu s$ duty $\leq 1/50$)		V
Average Rectified Output Current	I_O	20	$T_c=124^\circ C$ 50 Hz Full Sine Wave Resistive Load	A
RMS Forward Current	$I_{F(RMS)}$	22.2		A
Surge Forward Current	I_{FSM}	180	50Hz Full Sine Wave ,1cycle Non-repetitive	A
Operating JunctionTemperature Range	T_{jw}	-40 to +150		$^\circ C$
Storage Temperature Range	T_{stg}	-40 to +150		$^\circ C$
Mounting torque	Ftor	recommended torque = 0.5		N·m

Electrical • Thermal Characteristics

Characteristics	Symbol	Conditions	Min.	Typ.	Max.	Unit
Peak Reverse Current	I_{RM}	$T_j= 25^\circ C, V_{RM}= V_{RRM}$ per arm	-	-	1	mA
Peak Forward Voltage	V_{FM}	$T_j= 25^\circ C, I_{FM}= 10 A$ per arm	-	-	0.68	V
Thermal Resistance	Rth(j-c)	Junction to Case	-	-	1.5	$^\circ C /W$
	Rth(c-f)	Cace to Fin	-	-	1.5	$^\circ C /W$

FCH_A_OUTLINE DRAWING (Dimensions in mm)

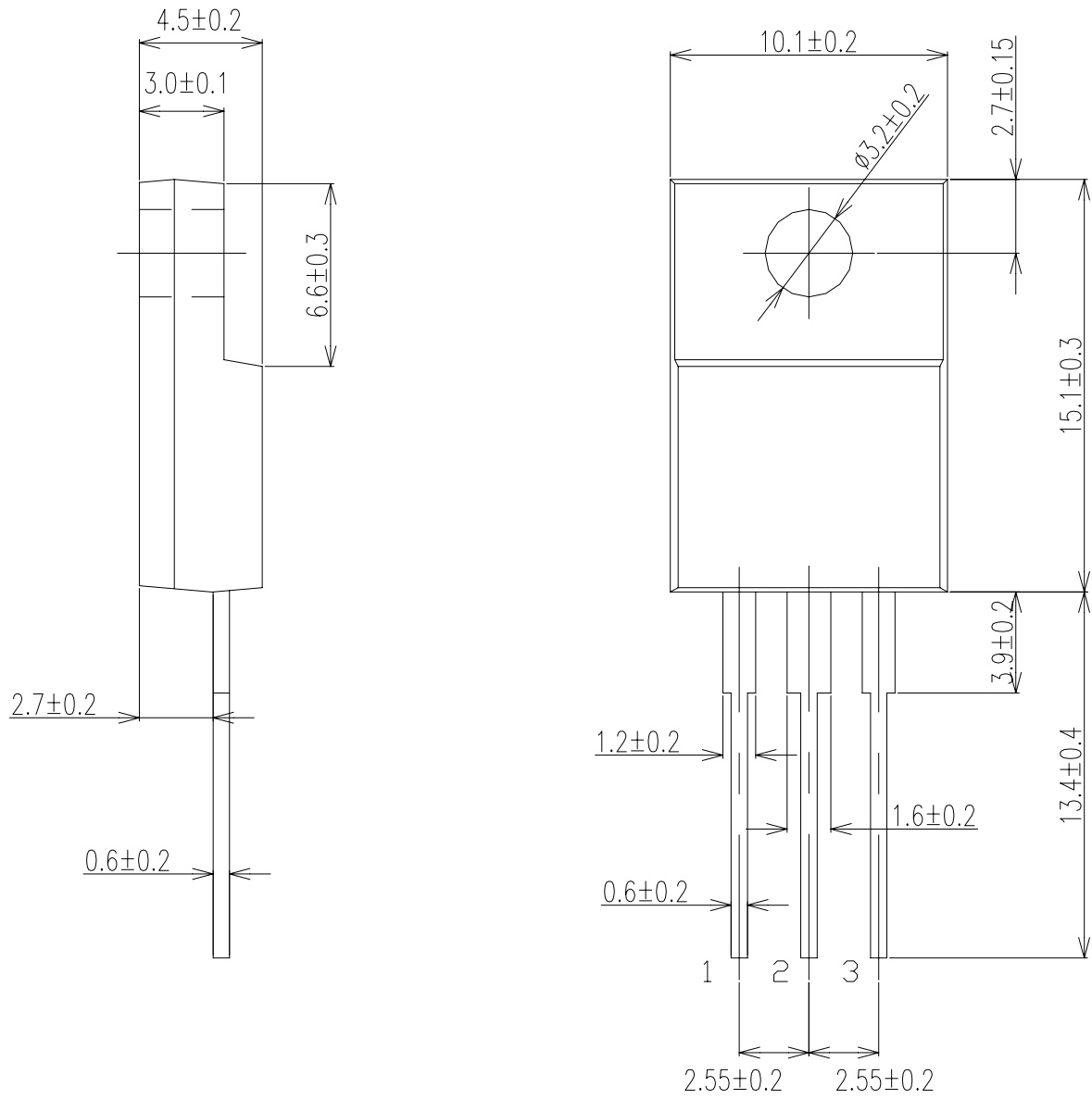

Center Tap

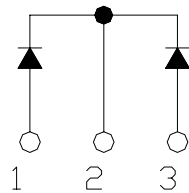

FORWARD CURRENT VS. VOLTAGE

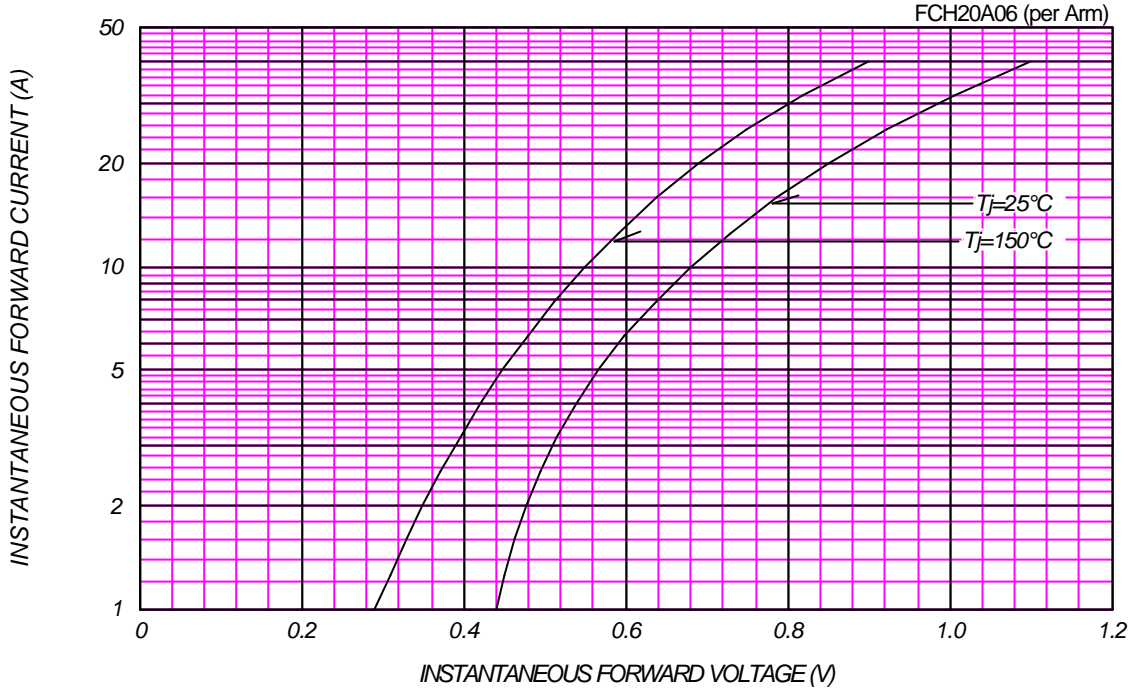

AVERAGE FORWARD POWER DISSIPATION

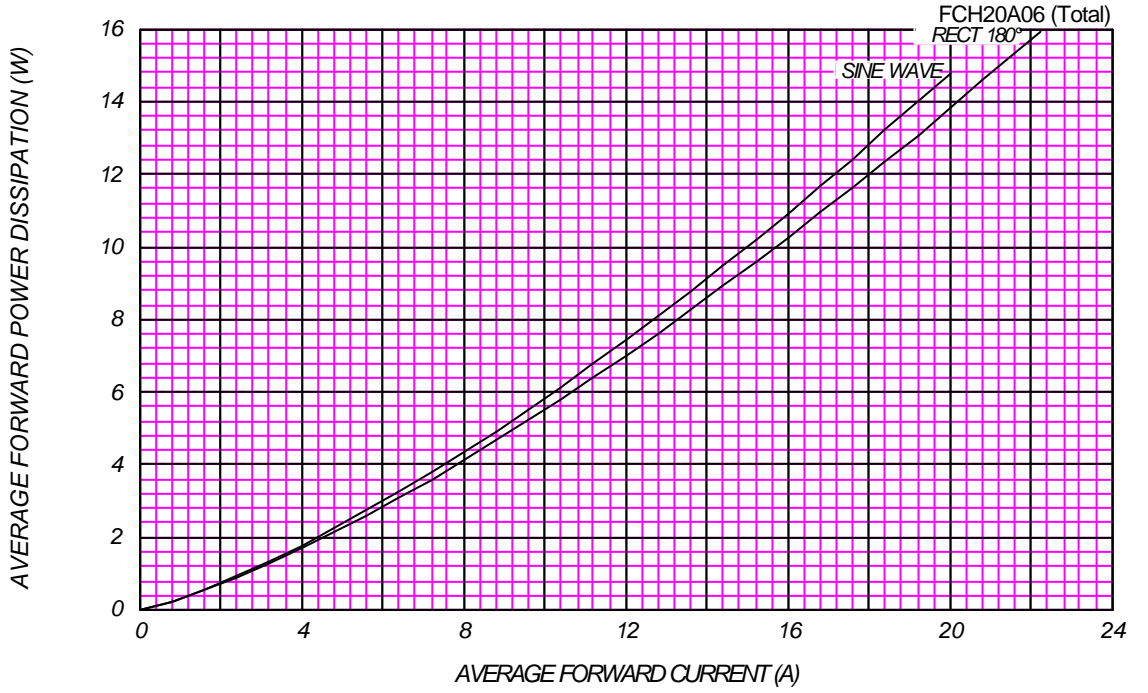

PEAK REVERSE CURRENT VS. PEAK REVERSE VOLTAGE

T_j = 150 °C

FCH20A06 (per Arm)

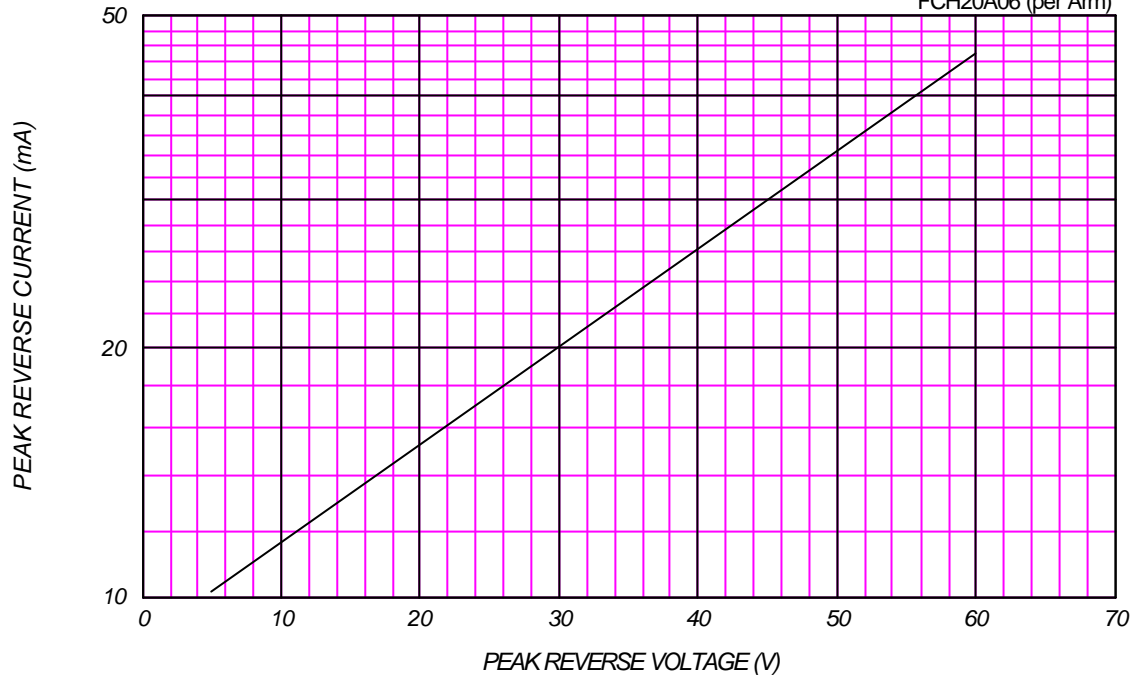

AVERAGE REVERSE POWER DISSIPATION

FCH20A06 (Total)

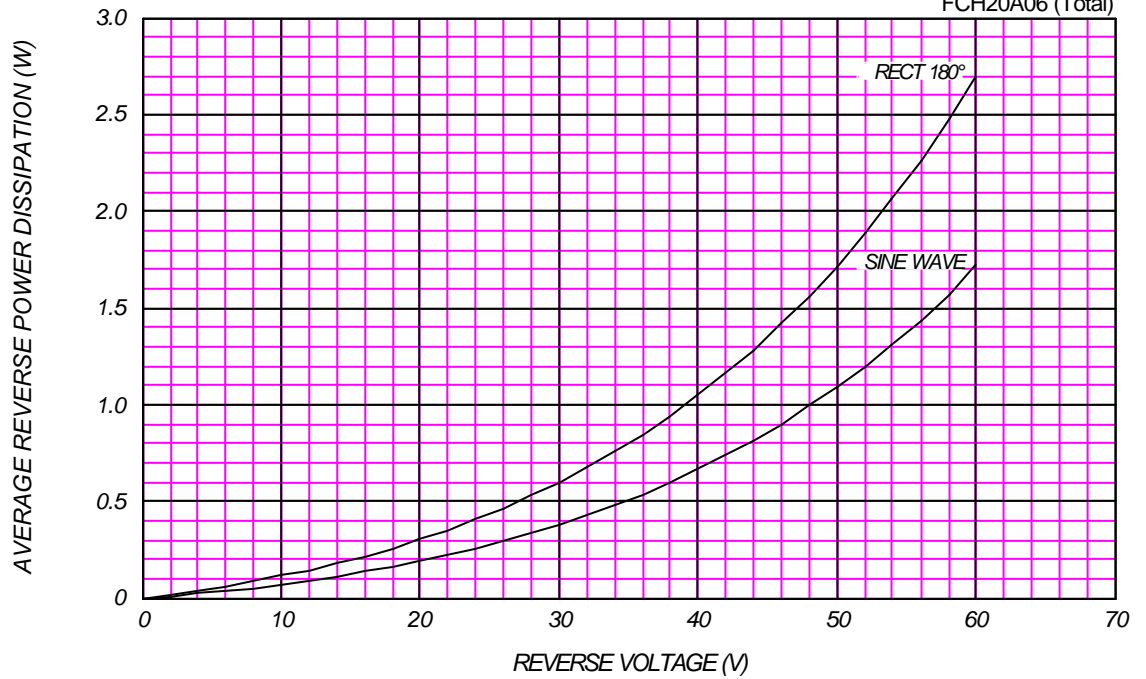



AVERAGE FORWARD CURRENT VS. CASE TEMPERATURE

$V_{RM}=60V$

FCH20A06 (Total)

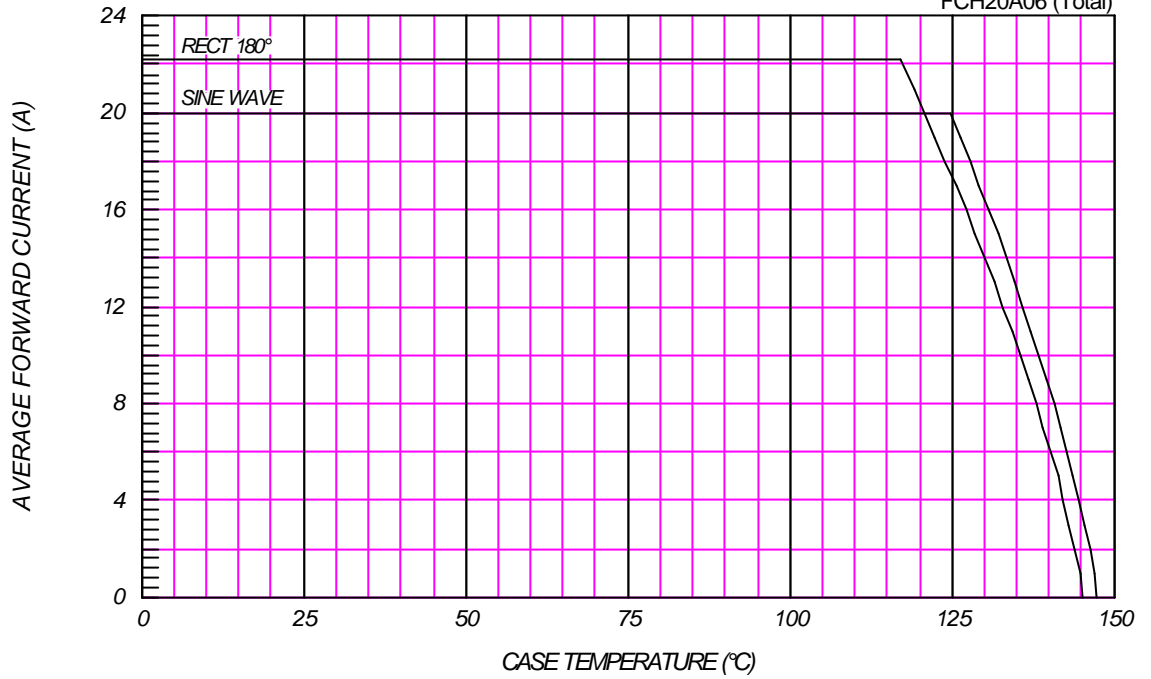

SURGE CURRENT RATINGS

f=50Hz, Sine Wave, Non-Repetitive, No Load

FCH20A06

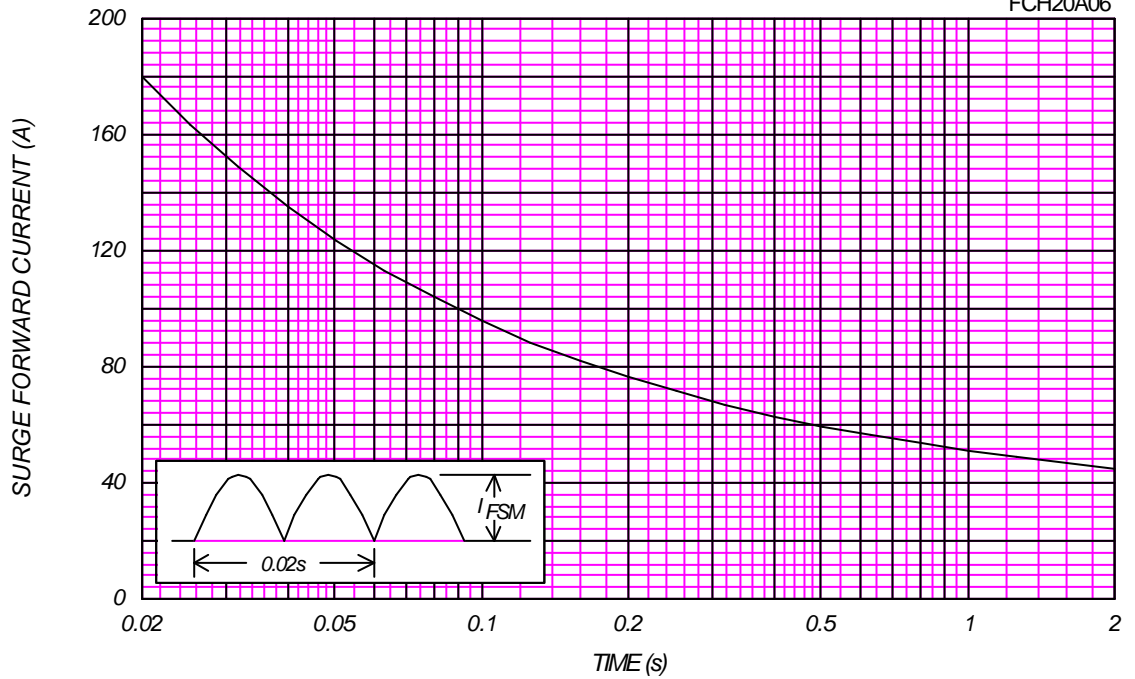

JUNCTION CAPACITANCE VS. REVERSE VOLTAGE

$T_j=25^\circ\text{C}$, $V_m=20\text{mV}_{\text{RMS}}$, $f=100\text{kHz}$, Typical Value

FCH20A06 (per Arm)

