

## Smart motor driver with embedded Hall sensor

### Features

- Motor driver with integrated Hall sensor
- Lock-shutdown protection & auto-restart function
- Precise magnetic switching thresholds
- “Soft-switch” phase-switching technique to reduce vibration and acoustic noise
- Thermal shutdown protection
- Available in SIP-4L packages
- For 12V systems

**Halogen Free**

### General Description

FD1157H is a two coil motor driver with embedded Hall sensor. It integrates the motor driver with the Hall sensor, which simplifies the PCB(printed circuit board) design and make the fabrication of small-size motors possible. Lock-shutdown and auto-restart function keeps the motor from being over-heated and restarts the motor after being locked.

“Soft-switch” phase-switching technique is used to reduce the vibration and acoustic noise.

Thermal-shutdown protection ensures the motor driver to operate under specified temperature ranges.

All the protection mechanisms mentioned above combine to provide a complete protecting scenario for the motor system, keep the motor system from possible damages and guarantee correct operations.

### Block Diagram

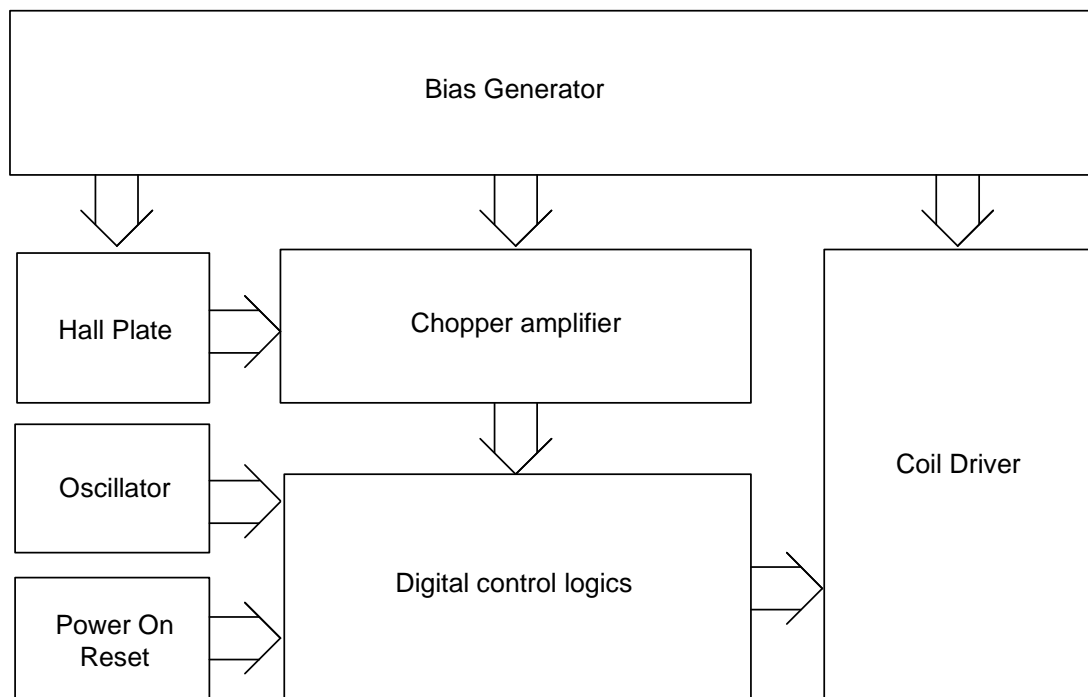

**Figure.1**

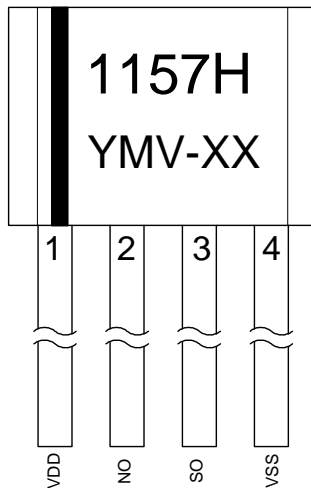
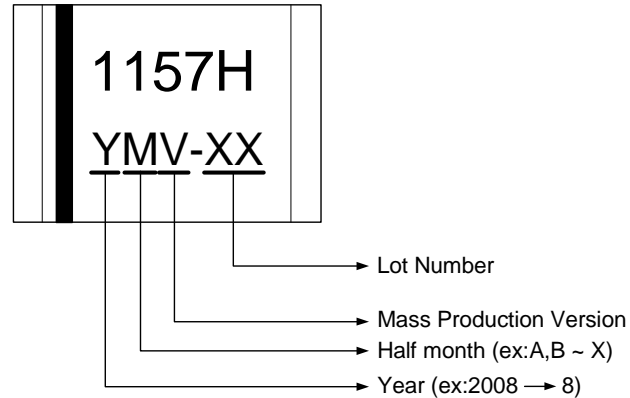
**Pin Connection**

**Figure.2**
**Marking Distinguish**

**Figure.3**
**Pin Descriptions**

Name	I/O	FD1157H	Description
VSS	G	4	Ground
SO	O	3	Driver output
NO	O	2	Driver output
VDD	P	1	Positive power supply

Legend: I=input, O=output, I/O=input/output, P=power supply, G=ground

**Functional Descriptions**

Refer to the block diagram (Figure.1), FD1157H is composed of the following building blocks:

- Bias generator

The bias generator provides precise, temperature- and process-insensitive bias references for the analog circuit blocks. These references guarantee proper operation of the IC under all conditions specified in this specification.

- Oscillator

The built-in oscillator provides the clock signal for the digital control logics

- Power-on Reset

Used to detect the power-up ramp and reset the digital circuits to achieve correct operation as soon as the power is ready.

- Chopper Amplifier

To achieve a higher magnetic sensitivity the chopper amplifier structure is adopted in this design. Use of this structure dynamically removes both the offset and flicker noise at the same time.

- Digital control logics

- Hall sensor part – generates controlling signals for the Hall sensor.
- Coil driver part – generates controlling signals for the Coil driver.

**Absolute Maximum Ratings**

Parameter	Symbol	Conditions	Values			Unit
			min.	Typ.	max.	
Operating Temperature	T <sub>OP</sub>	-	-20		105	°C
Storage Temperature	T <sub>ST</sub>	-	-40		150	°C
Output clamp Voltage	V <sub>C</sub>		25		27	V
DC Supply Voltage	V <sub>DD</sub>	-			18 <sup>(1)</sup>	V
Supply Current	I <sub>DD</sub>	-			6	mA
Continuous Current	I <sub>O(CONT)</sub>				600	mA
Hold Current	I <sub>O(HOLD)</sub>				900	mA
Peak Current	I <sub>O(PEAK)</sub>	<100μs			1200	mA
Junction temperature	T <sub>J</sub>				180	°C
Power Dissipation	P <sub>D</sub>	SIP-4L			1200	mW
Thermal Resistance	θ <sub>JC</sub>	SIP-4L		62		°C/W
Thermal Resistance	θ <sub>Ja</sub>	SIP-4L		104		°C/W
Magnetic Flux Density	B				Unlimited	Gauss
IR-Reflow Lead Temperature		10sec			260	°C

**Note 1:** V<sub>DD</sub>=18V, If V<sub>BEMF</sub> is lower than the output clamp voltage (V<sub>C</sub>).

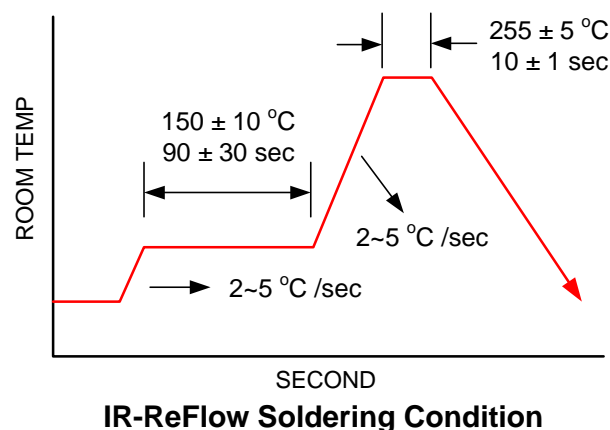
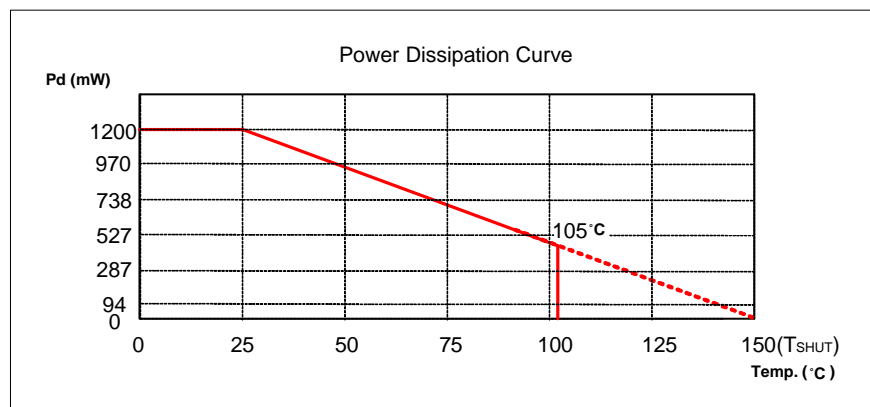

**Recommended Operating Conditions**

Parameter	Symbol	Conditions	Values			Unit
			min.	typ.	max.	
Supply Voltage	$V_{DD}$	-	3.0		16 <sup>(1)</sup>	V
Operating Temperature Range	$T_A$	-	-20		85	°C

**Note 1:**  $V_{DD}=16V$ , If  $V_{BEMF}$  is lower than the output clamp voltage ( $V_c$ ).

**Electrical Characteristics  $V_{DD}=12.0V$ ,  $T_A=25^\circ C$  (unless otherwise specified)**

Parameter	Symbol	Conditions	Values			Unit
			min.	typ.	max.	
Average Supply Current(no load)	$I_{DD}$			2.5		mA
On resistance (NO, SO pin)	$R_{DSON}$	$V_{DD}=5V$ , $T_A=25^\circ C$ , $I_{out}=300mA$		1		Ohm
Thermal Shutdown Threshold	$T_{SHUT}$		150			°C
Locked Rotor Period	$T_{ON}$			0.4		s
Locked Rotor Period	$T_{OFF}$			2.8		s

**Magnetic Characteristics**

Parameter	Symbol	Conditions	Values			Unit
			min.	typ.	max.	
Operate Points	$B_{OP}$		5	20	40	G
Release Points	$B_{RP}$		-5	-20	-40	G

**Driver output vs. Magnetic Pole**

Parameter	Test Conditions	NO	SO
North pole	$B < B_{rp}$	High	Low
South pole	$B > B_{op}$	Low	High

**Note:** The magnetic pole is applied facing the branded side of the package

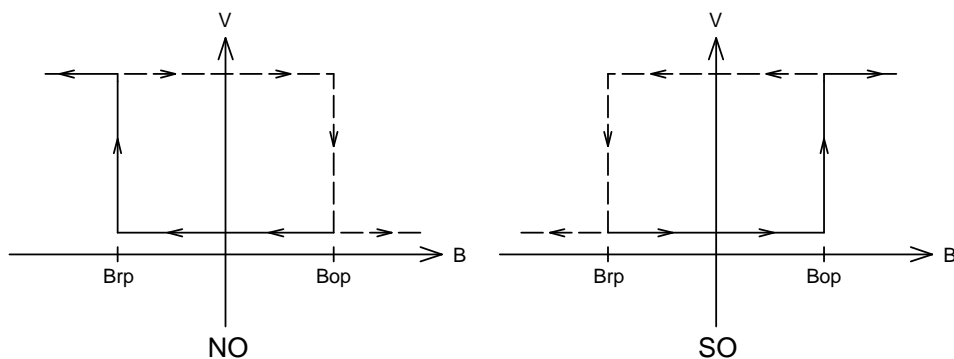
**Hysteresis Characteristics**

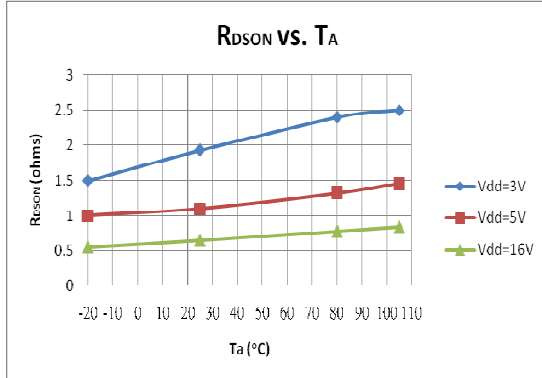
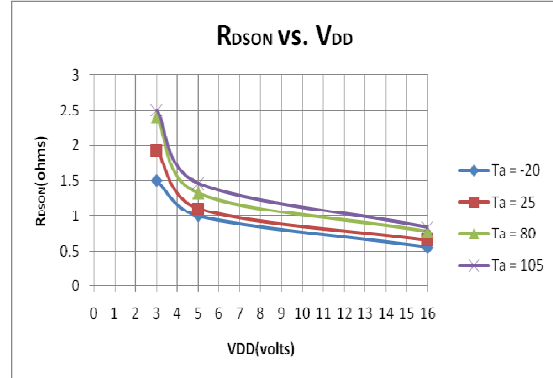
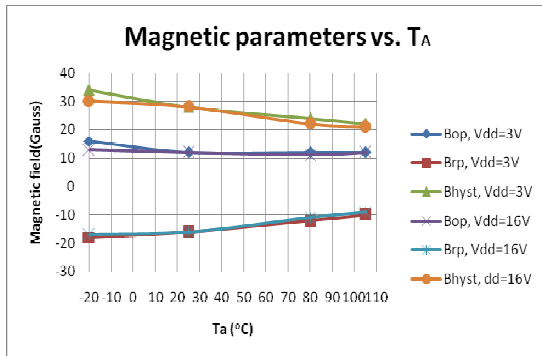
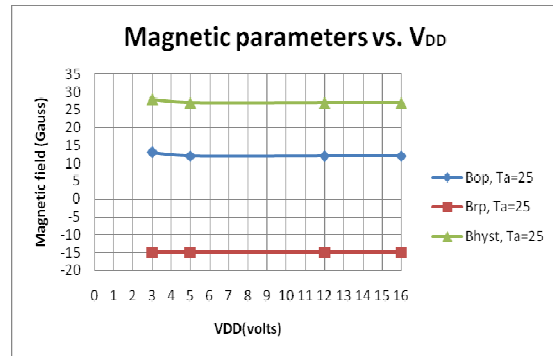
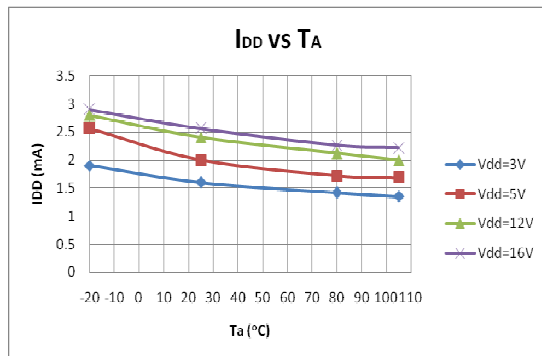
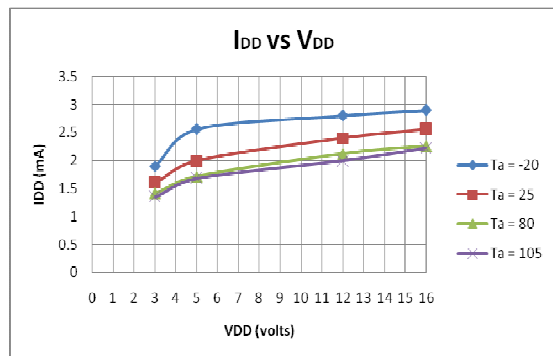
**Performance Graphs**

**Figure.4**

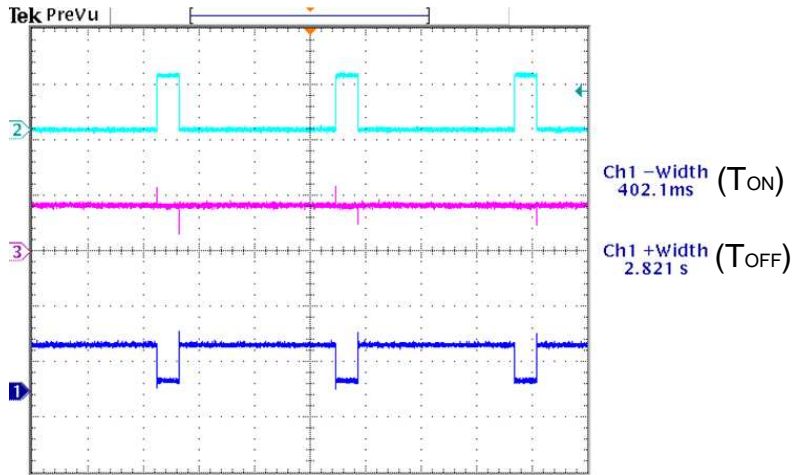
**Figure.5**

**Figure.6**

**Figure.7**

**Figure.8**

**Figure.9**

**Lock shutdown – Restart Timing Description:**



Channel2: V<sub>DD</sub> pin current waveform  
Channel3: Output (SO pin) voltage waveform  
Channel1: Output (NO pin) voltage waveform

**Note:** The North pole (B > Bop) is applied facing the branded side of the package.

**Application Circuit Reference**

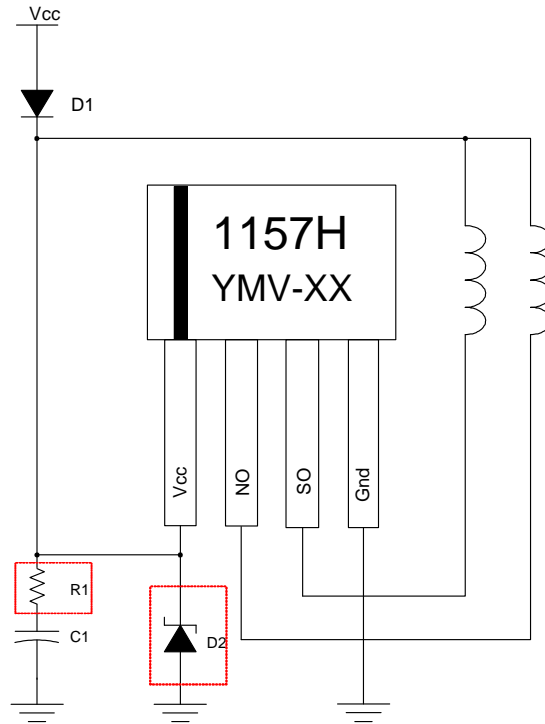
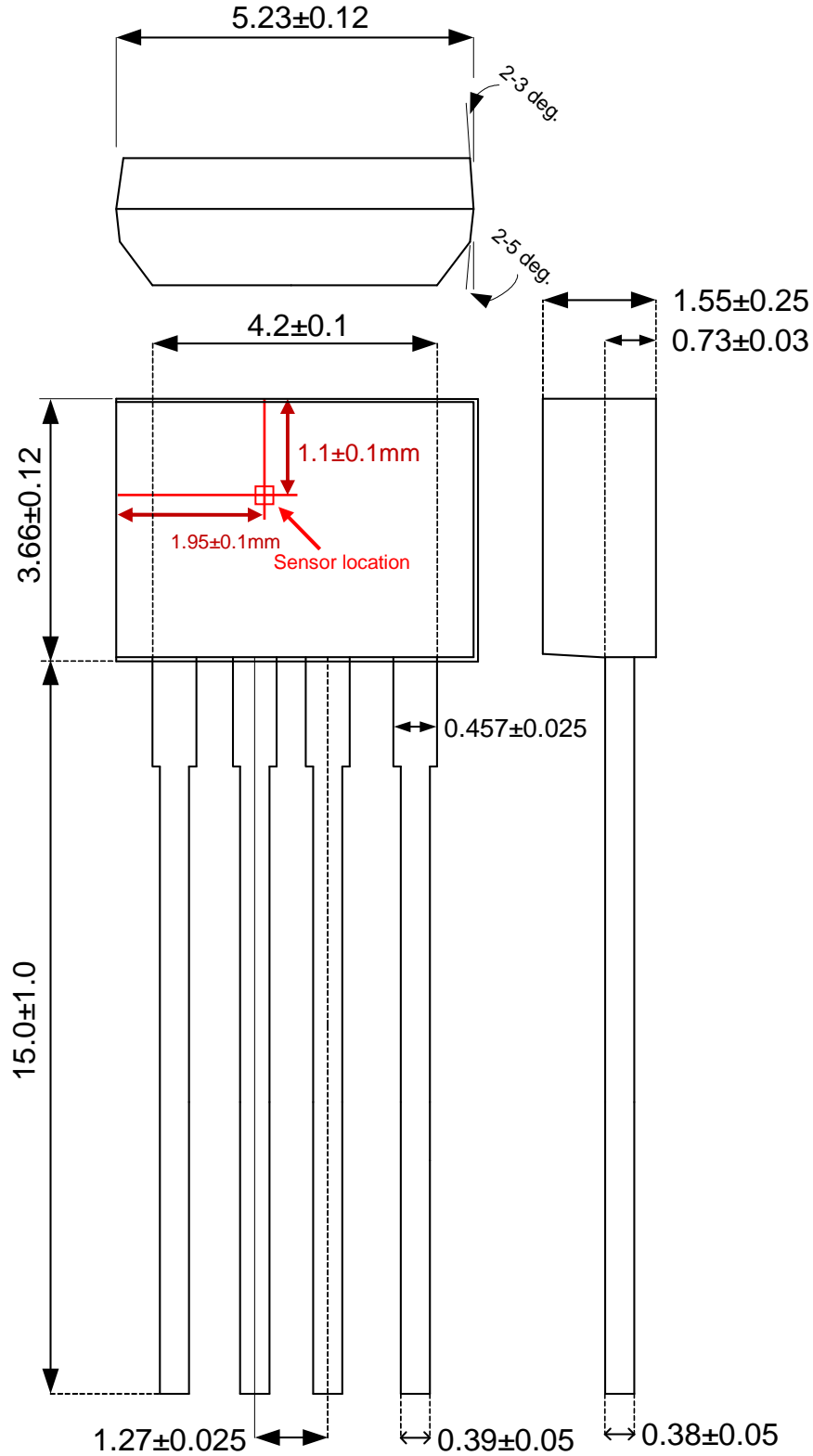

**Figure.10**

**Note:**  $C1=1\mu F$ ,  $R1=2\sim 5\text{ ohm(option)}$ ,  $D2(option)$  breakdown voltage 16V



Package Dimension (Unit: mm)  
SIP-4L(Halogen Free)







## Packing Specification

### BAG & BOX DIMANSION

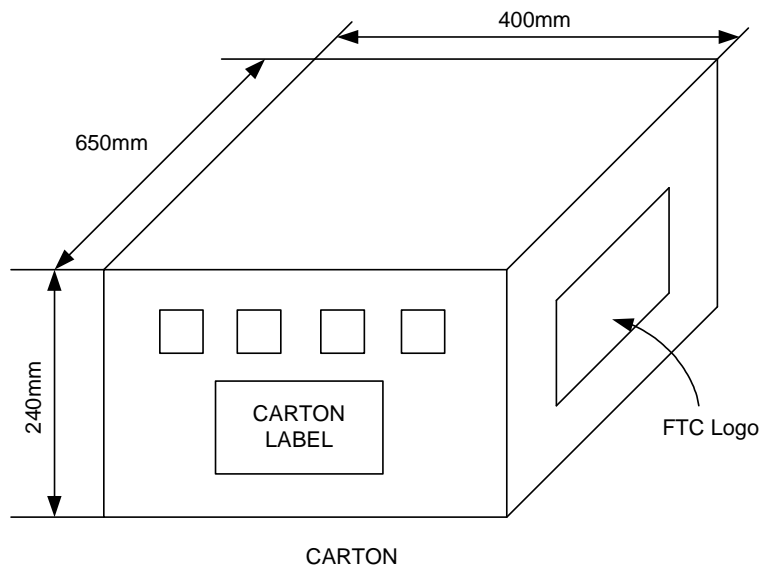
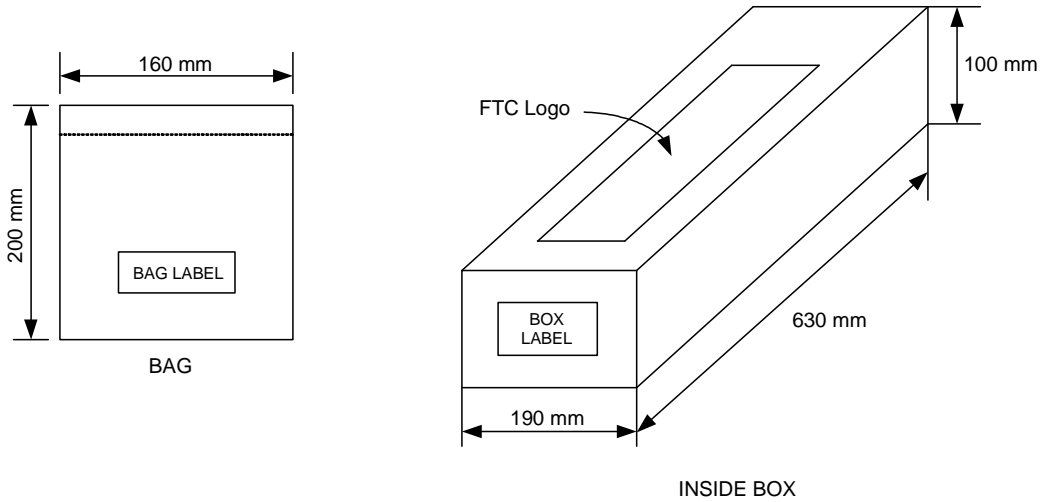

## Packing Quantity Specifications

1000 EA / 1 BAG

25 BAGS / 1 INSIDE BOX

4 INSIDE BOXES / 1 CARTON

**Order Information**

Part Number	Operating Temperature	Package	Description	Marking
FD1157H-G1	-20 °C to +85 °C	SIP-4L	±20G (B)	-