

Smart motor driver with embedded Hall sensor

Features

- Motor driver with high sensitivity Hall-effect sensor
- H-Bridge MOS driver
- Lock-shutdown protection & auto-restart function
- “Soft-switch” phase-switching technique to reduce vibration and acoustic noise
- Thermal shutdown protection(TSD)
- Available in SIP-4L package
- For 5V and 12V DC motor / FAN systems



General Description

FD1257AH is a single-phase full wave motor driver with embedded Hall-effect sensor IC. It integrates a H-bridge MOS driver, a high sensitivity hall-effect sensor, an event timer for rotor locked in SIP-4L package, which make the motors' PCBs(printed circuit boards) design easy and fabricate the high efficiency DC motors or FANs as simply as possible.

For safety, Lock-shutdown function would turn the IC's internal drivers off avoiding over-heat when the rotor is locked, and IC will try to re-start the rotor's torque after the time of these drivers' shutdown.

Thermal-shutdown protection (TSD) ensures the internal drivers of IC are operating under a safe operating temperature range.

All the protection mechanisms mentioned above combine to provide a complete protecting scenario in the motor system and avoid any possible damages and guarantee under a correct and safe operation.

Block Diagram

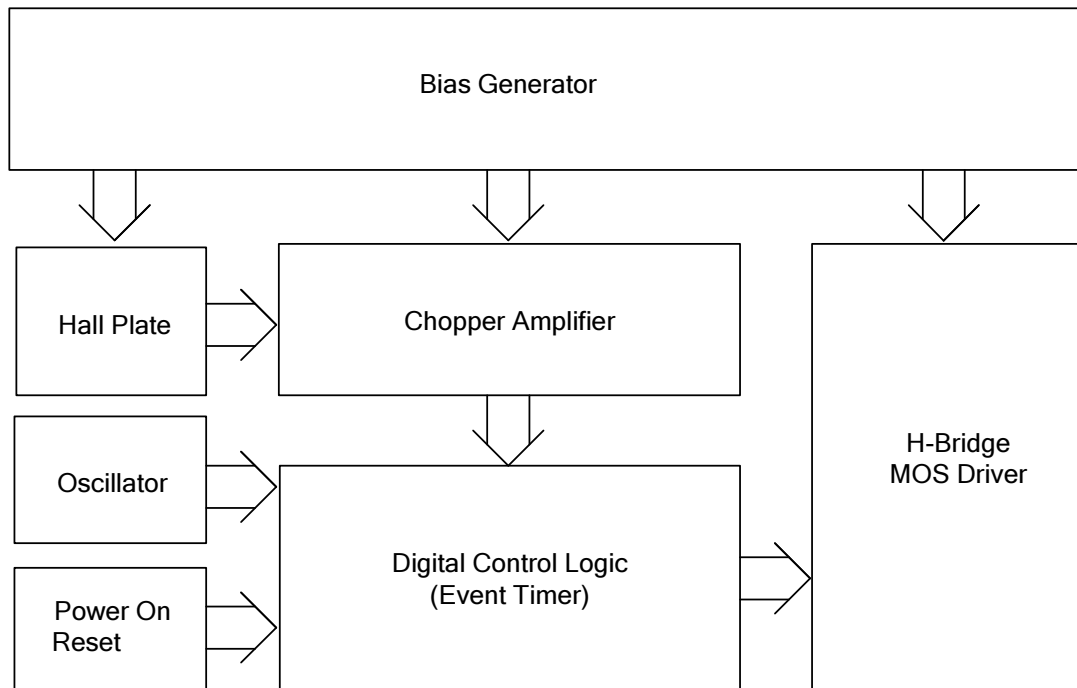
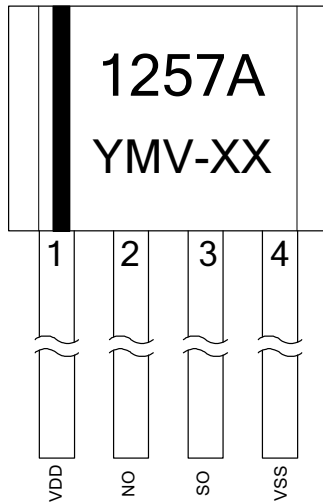
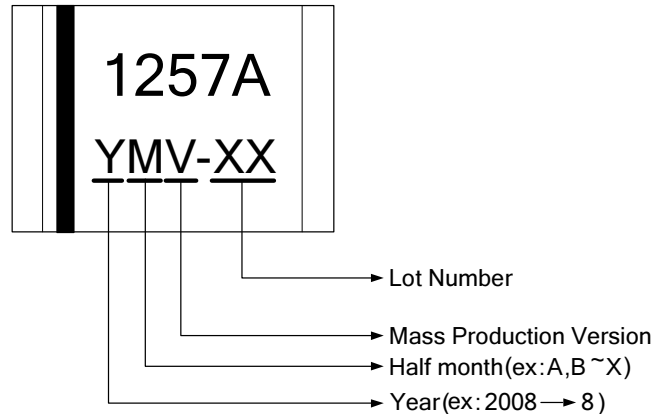

Figure.1

Pin Connection

Figure.2
Marking Distinguish

Figure.3
Pin Descriptions

Name	I/O	FD1257AH	Description
VDD	P	1	Positive Power Supply
NO	O	2	Driver Output 1
SO	O	3	Driver Output 2
VSS	G	4	Ground

Legend: I=input, O=output, I/O=input/output, P=power supply, G=ground

Functional Descriptions

Refer to the block diagram (Figure.1), FD1257AH is composed of the following building blocks:

- Bias generator

The bias generator provides precise, temperature- and process-insensitive bias references for the analog blocks. These references guarantee proper operation of the IC under all conditions specified in this specification.

- Oscillator

The built-in oscillator provides the clock signal for the digital control logic.

- Power On Reset

Used to detect the power-up ramp and reset the digital circuits to achieve correct operation as soon as the power is ready.

- Chopper Amplifier

To achieve a higher magnetic sensitivity the chopper amplifier structure is adopted in this design. Use of this structure dynamically removes both the offset and flicker noise at the same time.

- Digital Control Logic

- Hall sensor part – generates magnetic pole signals from the Hall-effect sensor.
- Driver part – generates switching signals to the H-Bridge MOS driver.
- Timer part – generates an interval of time when rotor locked event is occurred.

Absolute Maximum Ratings

Parameter	Symbol	Conditions	Values			Unit
			min.	Typ.	max.	
Operating Temperature	T_{OP}	-	-40		85	°C
Storage Temperature	T_{ST}	-	-55		150	°C
DC Supply Voltage	V_{DD}	$V_{SS} < V_{DD}$			18	V
Output Voltage (NO, SO)	V_{OUT}	$V_{DD} = 2.5V \sim 15V$			$V_{DD} + 0.3V$	V
Supply Current	I_{DD}	-			6	mA
Continuous Current	$I_{O(CONT)}$	$T_a = 25^\circ C$			450	mA
Hold Current	$I_{O(HOLD)}$	$T_a = 25^\circ C$			1000	mA
Peak Current	$I_{O(PEAK)}$	$< 100\mu s, T_a = 25^\circ C$			1200	mA
Junction temperature	T_J				180	°C
Power Dissipation	P_D	SIP-4L			1350	mW
Thermal Resistance	θ_{JC}	SIP-4L		55		°C/W
Thermal Resistance	θ_{JA}	SIP-4L		92.6		°C/W
Magnetic Flux Density	B				Unlimited	Gauss
IR-Reflow Lead Temperature	T_P	10sec			260	°C

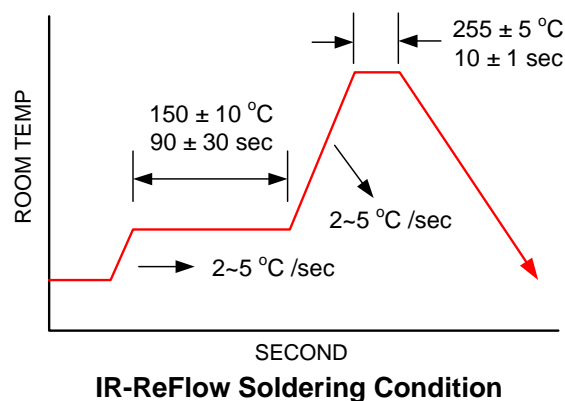
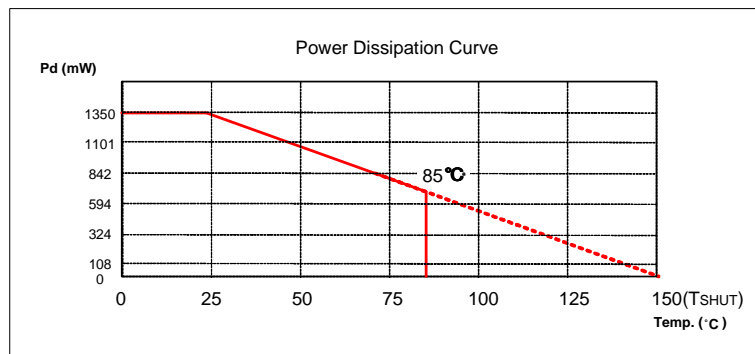

Recommended Operating Conditions

Parameter	Symbol	Conditions	Values			Unit
			min.	typ.	max.	
Supply Voltage	V_{DD}	-	2.5		17	V
Operating Temperature Range	T_a	-	-40		85	°C

Electrical Characteristics $T_a=25^\circ\text{C}$ (unless otherwise specified)

Parameter	Symbol	Conditions	Values			Unit
			min.	typ.	max.	
Average Supply Current(no load)	I_{DD}	$V_{DD} = 17\text{V}$		3.5		mA
On resistance ($R_{PMOS}+R_{NMOS}$)	$R_{DS(ON)}$	$V_{DD} = 2.5\text{V}$	4.5	5.0	5.5	Ω
		$V_{DD} = 17\text{V}$		2.5		
Thermal Shutdown Threshold	T_{SHUT}		150			°C
Locked Rotor Period	T_{ON}			0.4		s
Locked Rotor Period	T_{OFF}			4.1		s

Magnetic Characteristics

Parameter	Symbol	Conditions	Values			Unit
			min.	typ.	max.	
Operate Points	B_{OP}		5	25	50	G
Release Points	B_{RP}		-5	-25	-50	G
Hysteresis	B_{HYS}		10	50	100	G

Driver output vs. Magnetic Pole

Parameter	Test Conditions	NO	SO
North pole	$B < B_{rp}$	High	Low
South pole	$B > B_{op}$	Low	High

Note: The magnetic pole is applied facing the branded side of the package

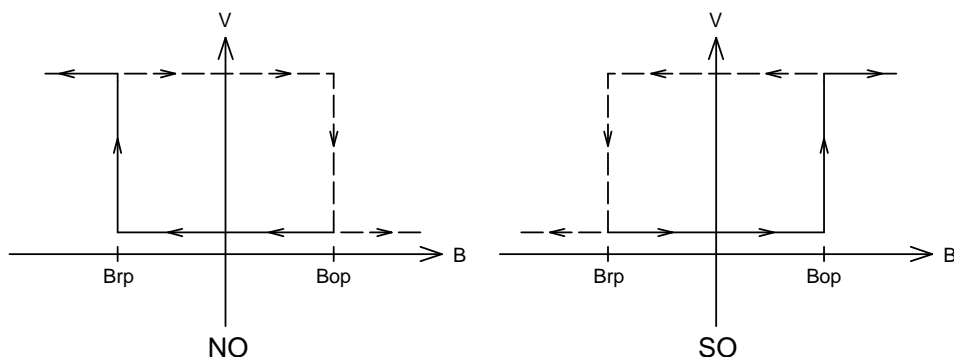
Hysteresis Characteristics

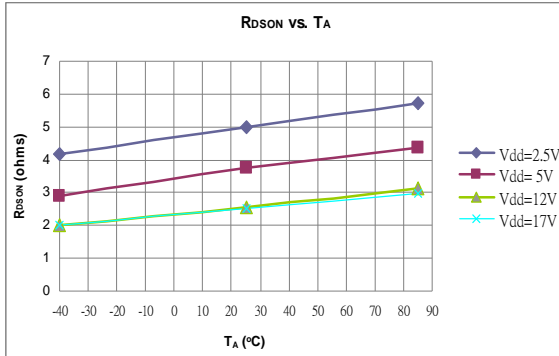
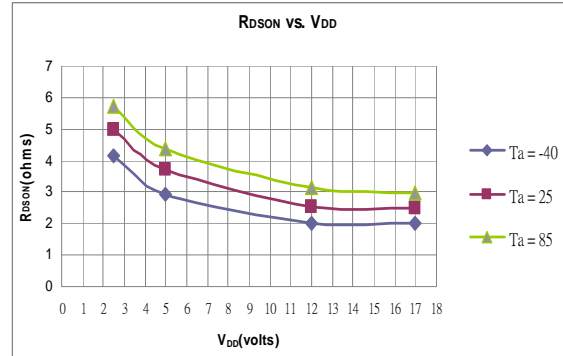
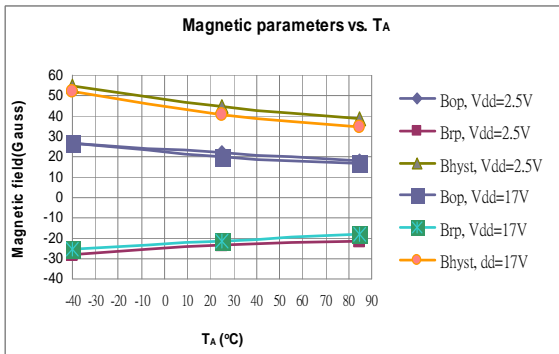
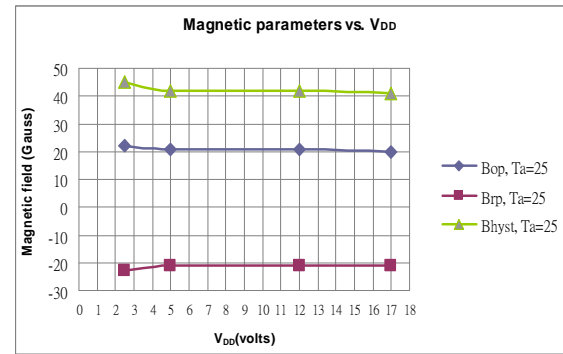
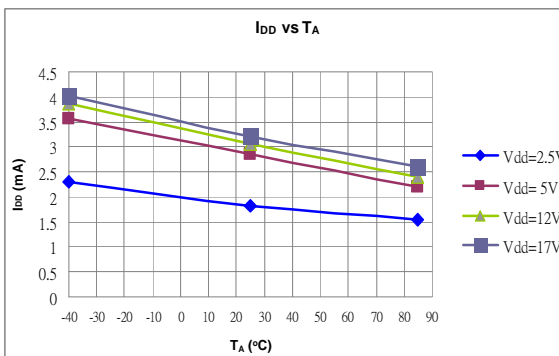
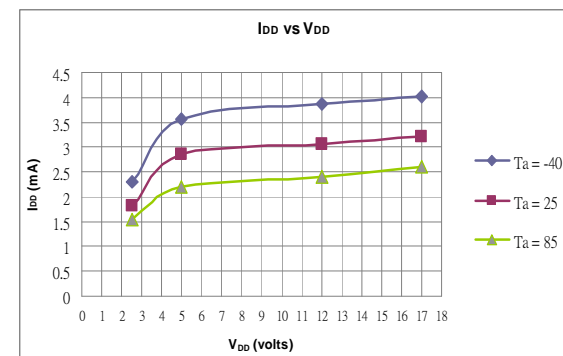
Performance Graphs

Figure.4

Figure.5

Figure.6

Figure.7

Figure.8

Figure.9



Application Circuit Reference

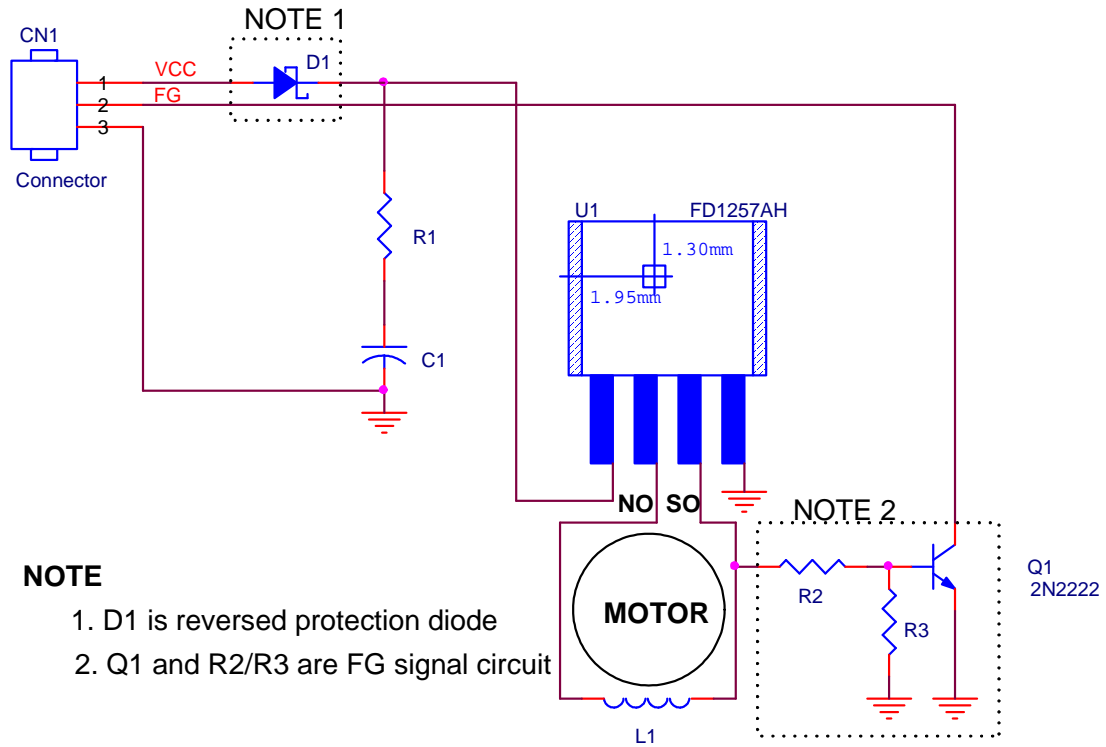

Figure.10 FD1257AH Typical Application Circuits

Note:

- 1). Must use least $C1=1\mu F$ (electrolytic) capacitor & $R1=0\sim 10$ Ohm for the decoupling between V_{DD} and V_{SS} and place the capacitor as close to the IC as possible.
- 2). D1 is a low forward diode for IC reversed supply voltage protection.



FD1257AH Output Waveforms Description

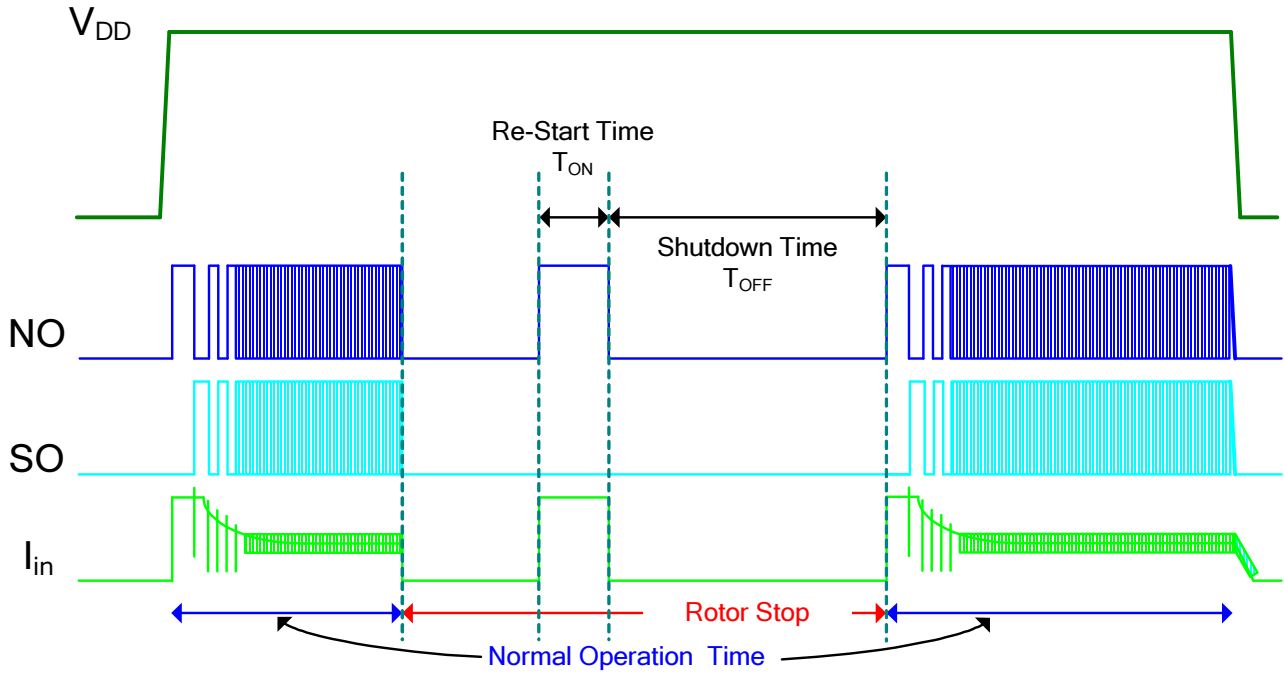
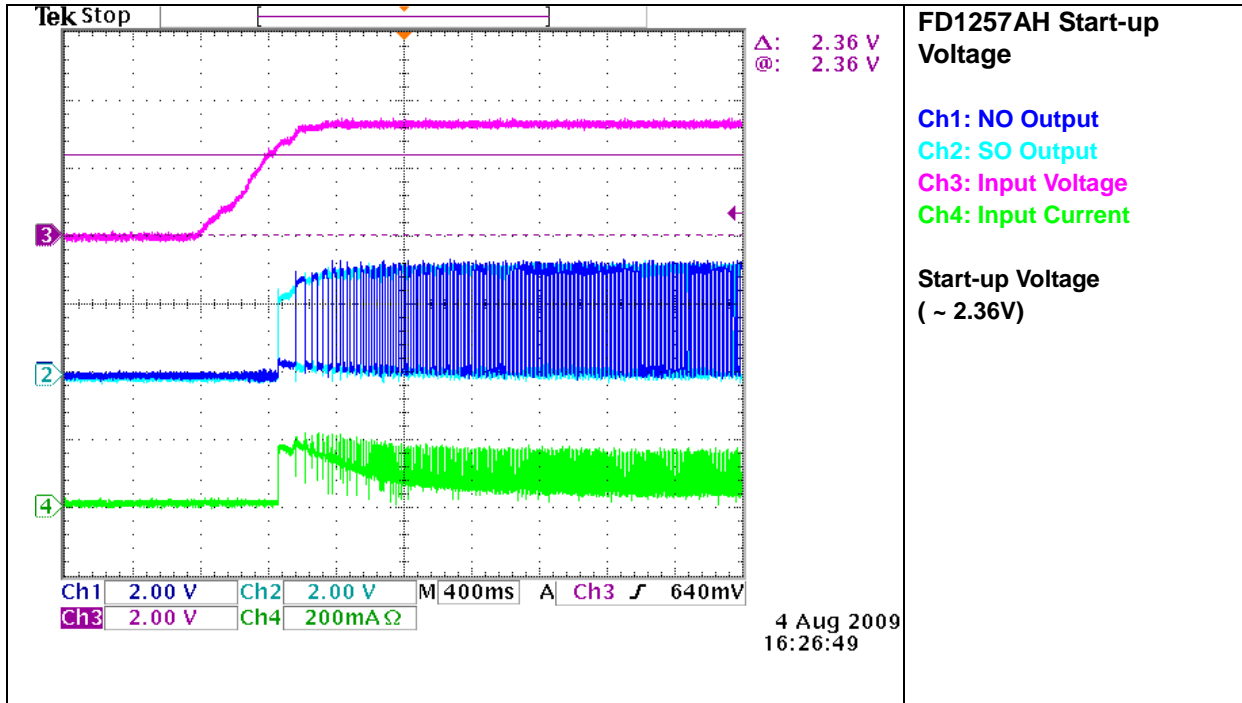
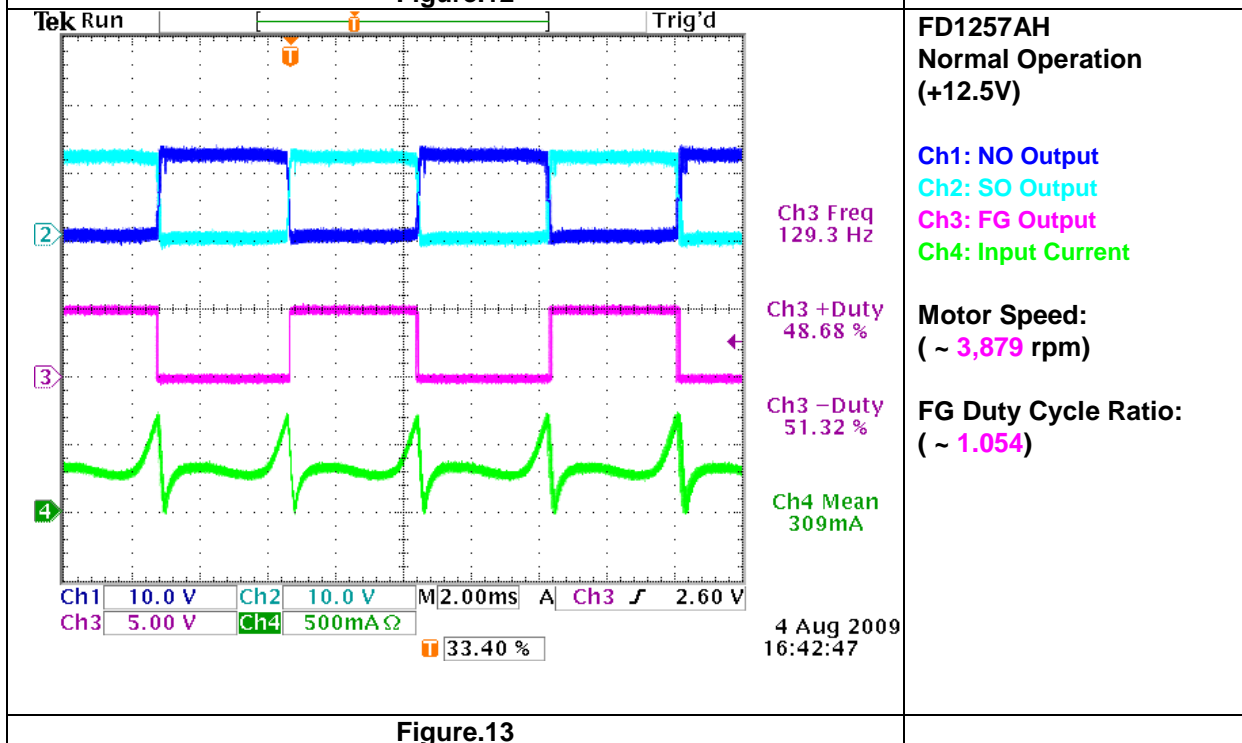
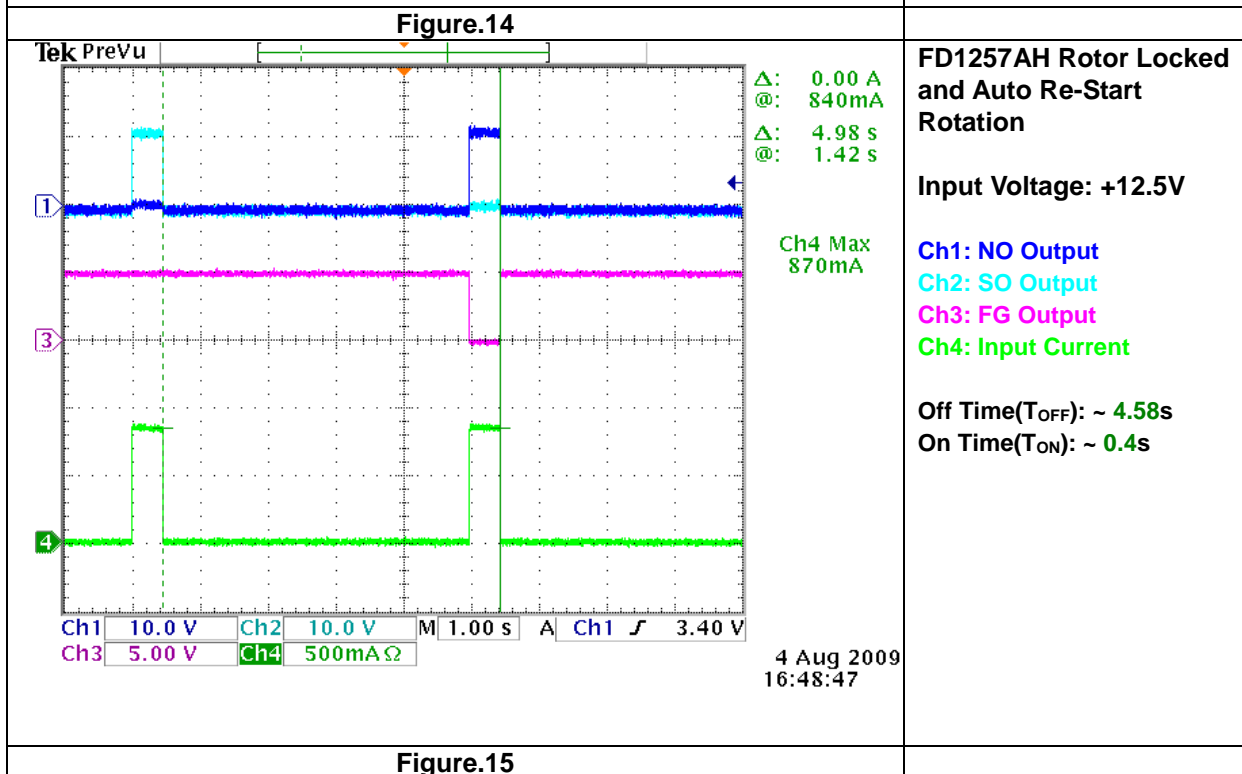
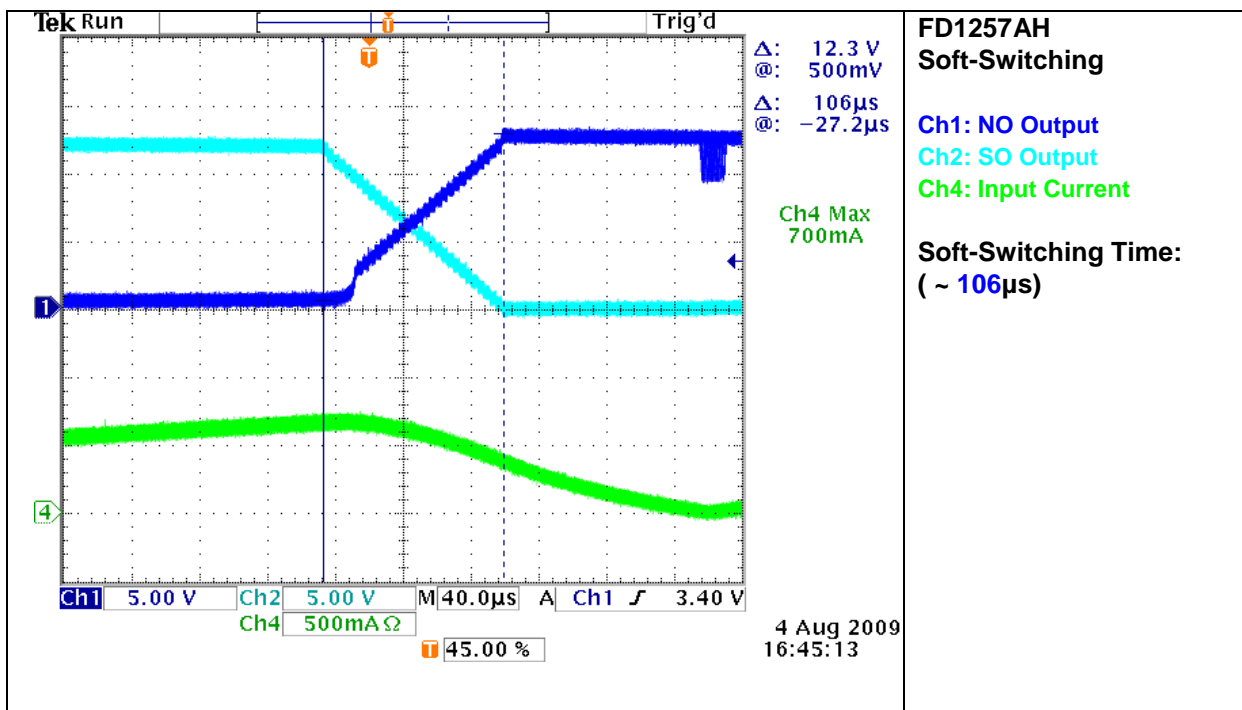
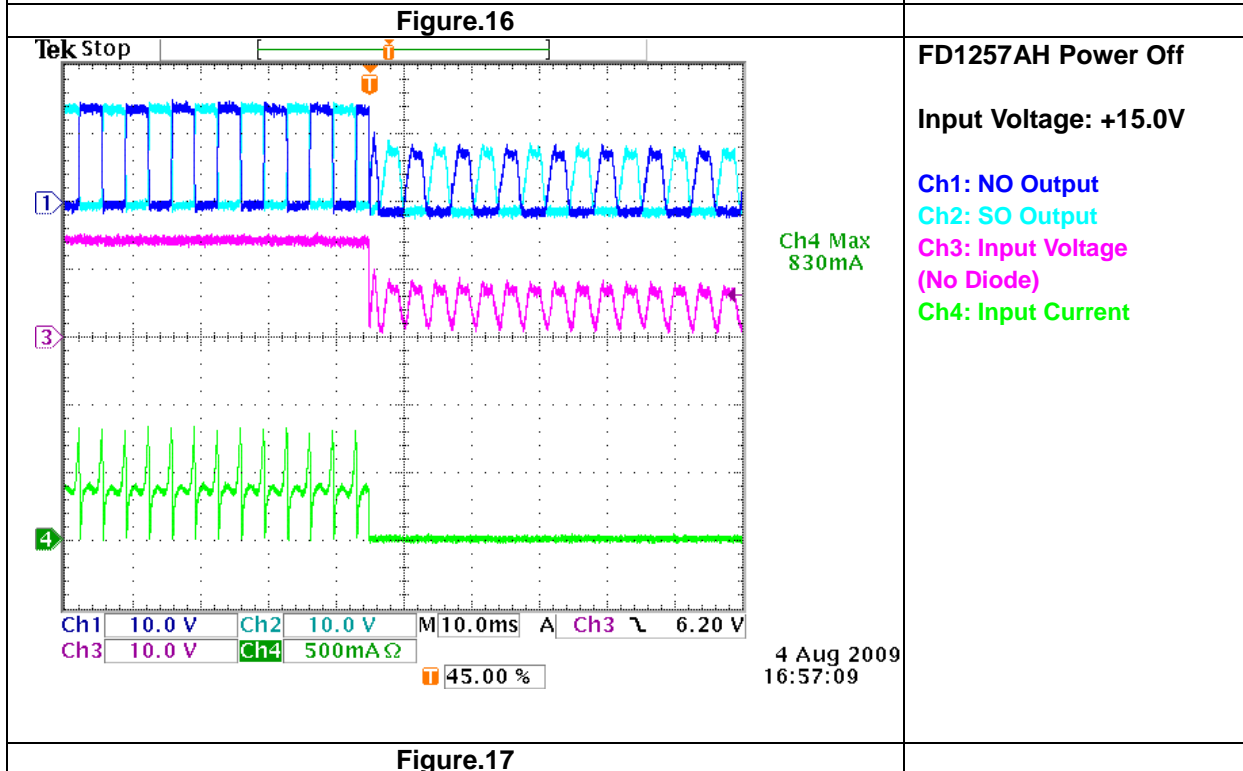
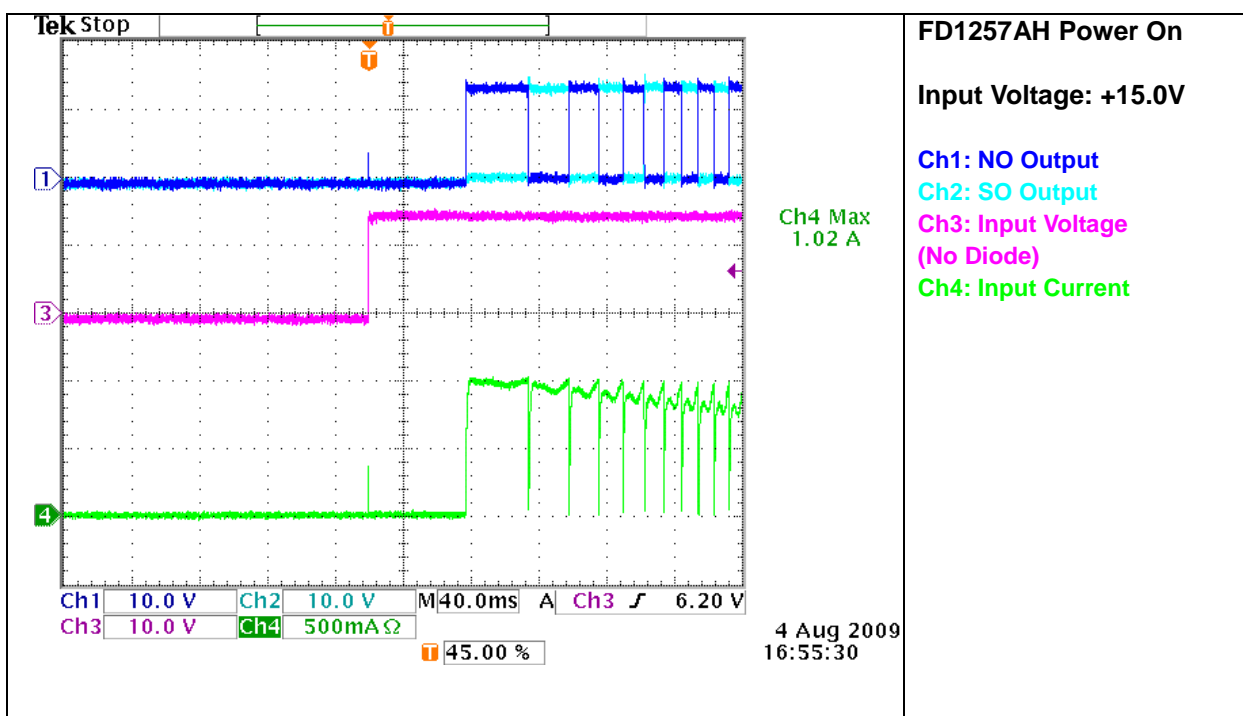

Figure.11

FD1257AH Output Waveforms Measurement

Figure.12

Figure.13





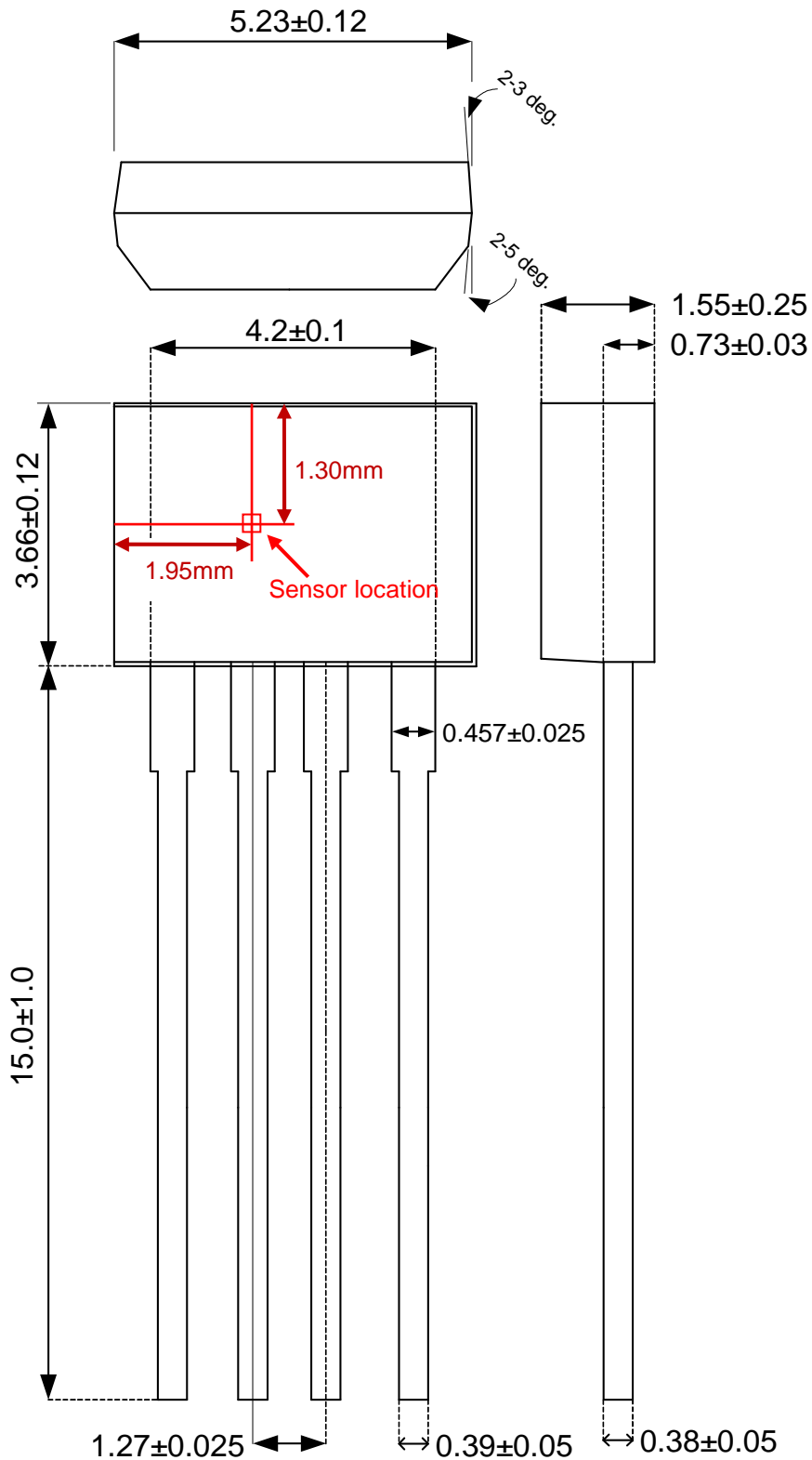

Package Dimension (Unit: mm)
SIP-4L(Halogen Free)

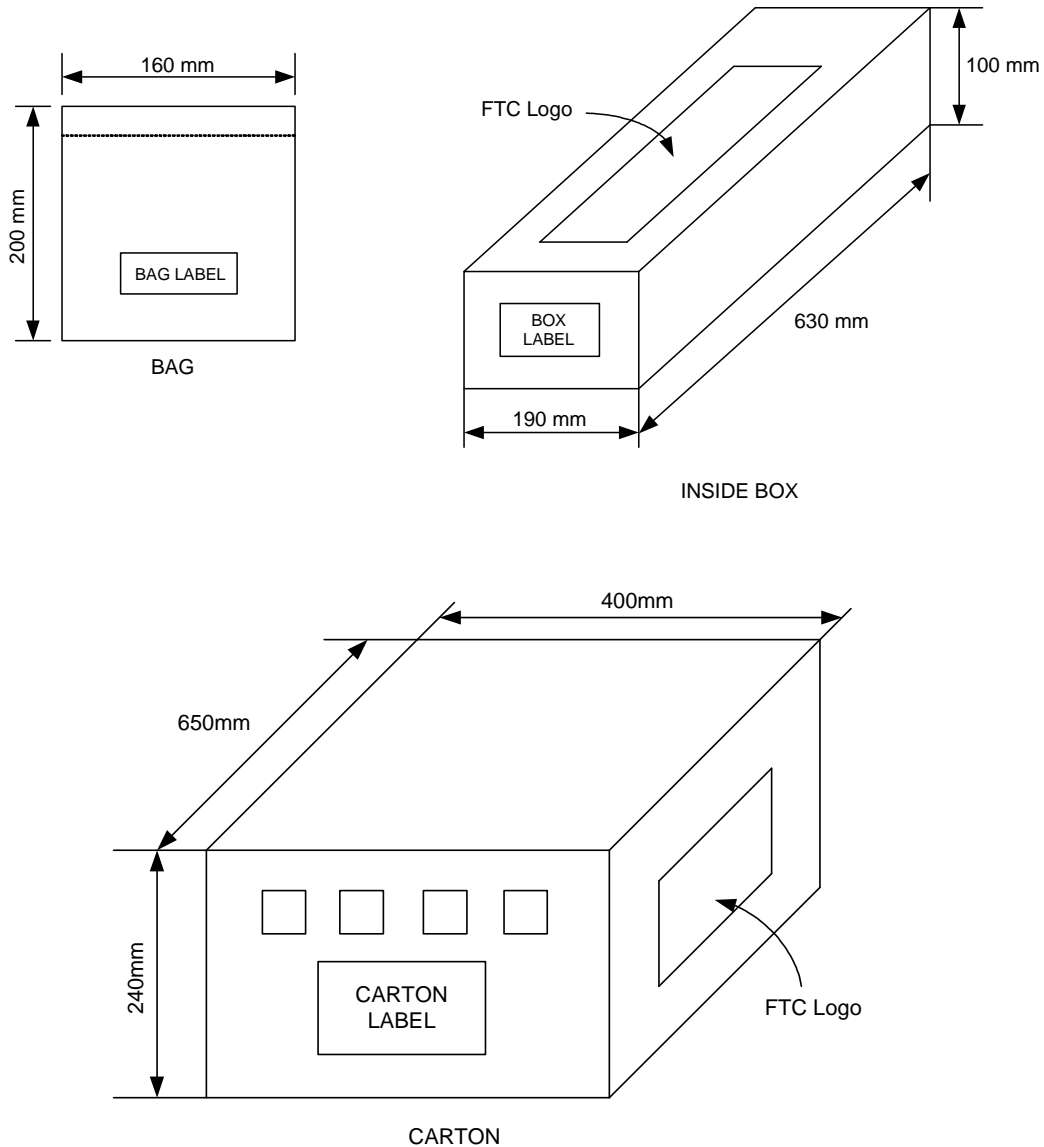

Packing Specification
BAG & BOX DIMANSION

Packing Quantity Specifications

1000 EA / 1 BAG

20 BAGS / 1 INSIDE BOX

4 INSIDE BOXES / 1 CARTON

Order Information

Part Number	Operating Temperature	Package	Description	MOQ	MSL
FD1257AH-G1	-40 °C to +85 °C	SIP-4L	±50G (B)	1,000 EA / BAG	3