

FDA2712

N-Channel UltraFET Trench MOSFET

250V, 64A, 34mΩ

Features

- $R_{DS(on)} = 29.2m\Omega @ V_{GS} = 10V, I_D = 40A$
- Fast switching speed
- Low gate charge
- High performance trench technology for extremely low $R_{DS(on)}$
- High power and current handling capability
- RoHS compliant

Description

This N-Channel MOSFET is produced using Fairchild Semiconductor's advanced PowerTrench process that has been especially tailored to minimize the on-state resistance and yet maintain superior switching performance.

Applications

- PDP application

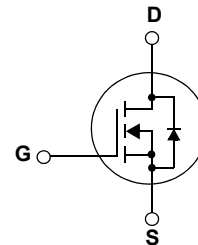
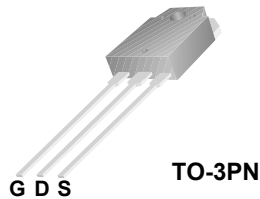

MOSFET Maximum Ratings

Symbol	Parameter	Ratings	Units
V_{DSS}	Drain to Source Voltage	250	V
V_{GSS}	Gate to Source Voltage	±30	V
I_D	Drain Current	-Continuous ($T_C = 25^\circ C$)	64
		-Continuous ($T_C = 100^\circ C$)	44
I_{DM}	Drain Current	- Pulsed (Note 1)	240
E_{AS}	Single Pulsed Avalanche Energy	(Note 2)	245
dv/dt	Peak Diode Recovery dv/dt	(Note 3)	4.5
P_D	Power Dissipation	($T_C = 25^\circ C$)	357
		- Derate above $25^\circ C$	2.85
T_J, T_{STG}	Operating and Storage Temperature Range	-55 to +150	$^\circ C$
T_L	Maximum Lead Temperature for Soldering Purpose, 1/8" from Case for 5 Seconds	300	$^\circ C$

Thermal Characteristics

Symbol	Parameter	Ratings	Units
$R_{\theta JC}$	Thermal Resistance, Junction to Case	0.35	$^\circ C/W$
$R_{\theta JA}$	Thermal Resistance, Junction to Ambient	40	

Package Marking and Ordering Information $T_C = 25^\circ\text{C}$ unless otherwise noted

Device Marking	Device	Package	Reel Size	Tape Width	Quantity
FDA2712	FDA2712	TO-3PN	N/A	N/A	30

Electrical Characteristics

Symbol	Parameter	Test Conditions	Min.	Typ.	Max.	Units
--------	-----------	-----------------	------	------	------	-------

Off Characteristics

BV_{DSS}	Drain to Source Breakdown Voltage	$I_D = 250\mu\text{A}$, $V_{GS} = 0\text{V}$, $T_J = 25^\circ\text{C}$	250	-	-	V
$\Delta BV_{DSS} / \Delta T_J$	Breakdown Voltage Temperature Coefficient	$I_D = 250\mu\text{A}$, Referenced to 25°C	-	0.2	-	$\text{V}/^\circ\text{C}$
I_{DSS}	Zero Gate Voltage Drain Current	$V_{DS} = 250\text{V}$ $V_{GS} = 0\text{V}$ $T_J = 125^\circ\text{C}$	-	-	1	μA
I_{GSS}	Gate to Body Leakage Current	$V_{GS} = \pm 20\text{V}$, $V_{DS} = 0\text{V}$	-	-	± 100	nA

On Characteristics

$V_{GS(th)}$	Gate Threshold Voltage	$V_{GS} = V_{DS}$, $I_D = 250\mu\text{A}$	3.0	3.9	5.0	V
$R_{DS(on)}$	Static Drain to Source On Resistance	$V_{GS} = 10\text{V}$, $I_D = 40\text{A}$	-	29.2	34	m Ω
g_{FS}	Forward Transconductance	$V_{DS} = 10\text{V}$, $I_D = 40\text{A}$ (Note 4)	-	43	-	S

Dynamic Characteristics

C_{iss}	Input Capacitance	$V_{DS} = 25\text{V}$, $V_{GS} = 0\text{V}$ $f = 1\text{MHz}$	-	7650	10175	pF
C_{oss}	Output Capacitance		-	550	735	pF
C_{rss}	Reverse Transfer Capacitance		-	105	155	pF
Q_g	Total Gate Charge at 10V	$V_{DS} = 125\text{V}$, $I_D = 80\text{A}$ $V_{GS} = 10\text{V}$ (Note 4, 5)	-	99	129	nC
Q_{gs}	Gate to Source Gate Charge		-	46	-	nC
Q_{gd}	Gate to Drain "Miller" Charge		-	21	-	nC

Switching Characteristics

$t_{d(on)}$	Turn-On Delay Time	$V_{DD} = 125\text{V}$, $I_D = 80\text{A}$ $V_{GS} = 10\text{V}$, $R_{GEN} = 25\Omega$ (Note 4, 5)	-	128	266	ns
t_r	Turn-On Rise Time		-	371	751	ns
$t_{d(off)}$	Turn-Off Delay Time		-	143	295	ns
t_f	Turn-Off Fall Time		-	210	429	ns

Drain-Source Diode Characteristics

I_S	Maximum Continuous Drain to Source Diode Forward Current	-	-	80	A	
I_{SM}	Maximum Pulsed Drain to Source Diode Forward Current	-	-	240	A	
V_{SD}	Drain to Source Diode Forward Voltage	$V_{GS} = 0\text{V}$, $I_{SD} = 80\text{A}$	-	-	1.2	V
t_{rr}	Reverse Recovery Time	$V_{GS} = 0\text{V}$, $I_{SD} = 80\text{A}$	-	175	-	ns
Q_{rr}	Reverse Recovery Charge	$di_F/dt = 100\text{A}/\mu\text{s}$ (Note 4)	-	1.17	-	μC

Notes:

1. Repetitive Rating: Pulse width limited by maximum junction temperature
2. $L = 1\text{mH}$, $I_{AS} = 22.2\text{A}$, $V_{DD} = 50\text{V}$, $R_G = 25\Omega$, Starting $T_J = 25^\circ\text{C}$
3. $I_{SD} \leq 80\text{A}$, $di/dt \leq 200\text{A}/\mu\text{s}$, $V_{DD} \leq BV_{DSS}$, Starting $T_J = 25^\circ\text{C}$
4. Pulse Test: Pulse width $\leq 300\mu\text{s}$, Duty Cycle $\leq 2\%$
5. Essentially Independent of Operating Temperature Typical Characteristics

Typical Performance Characteristics

Figure 1. On-Region Characteristics

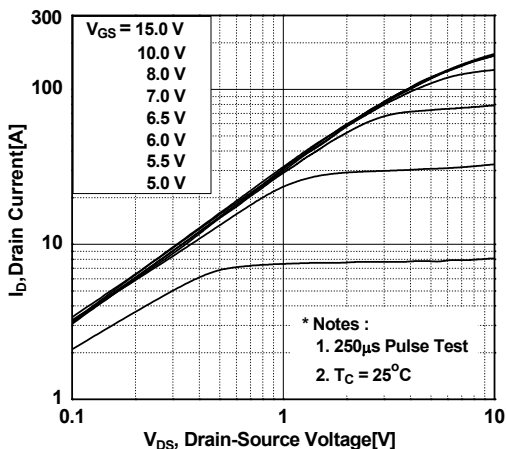

Figure 2. Transfer Characteristics

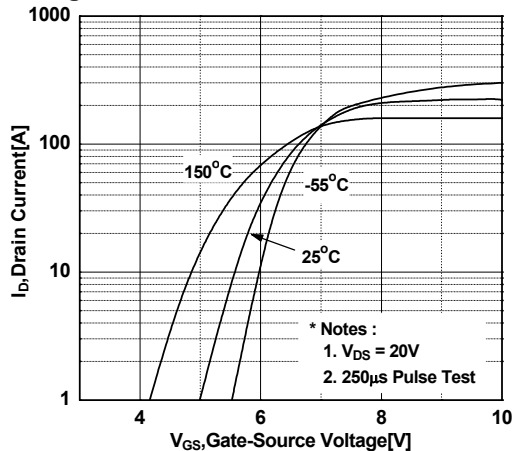

Figure 3. On-Resistance Variation vs. Drain Current and Gate Voltage

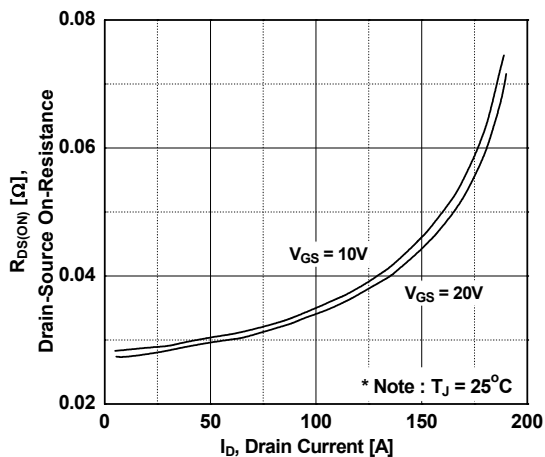

Figure 4. Body Diode Forward Voltage Variation vs. Source Current and Temperature

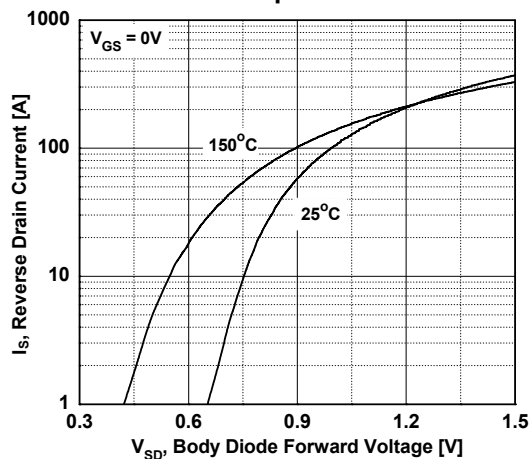

Figure 5. Capacitance Characteristics

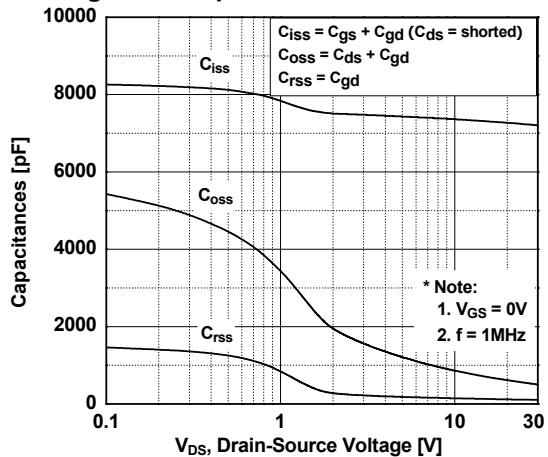
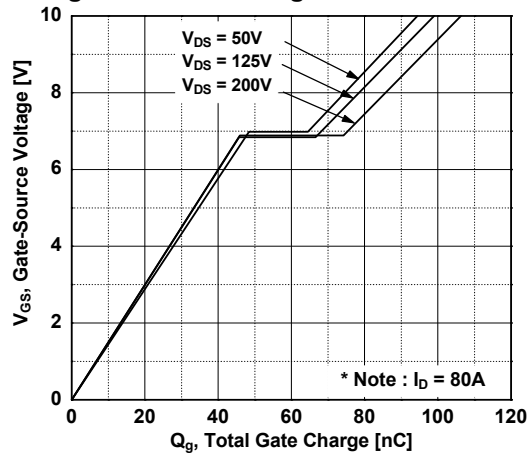

Figure 6. Gate Charge Characteristics



Typical Performance Characteristics (Continued)

Figure 7. Breakdown Voltage Variation vs. Temperature

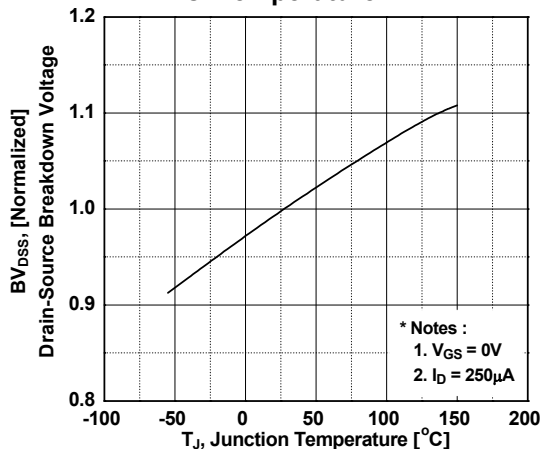

Figure 8. On-Resistance Variation vs. Temperature

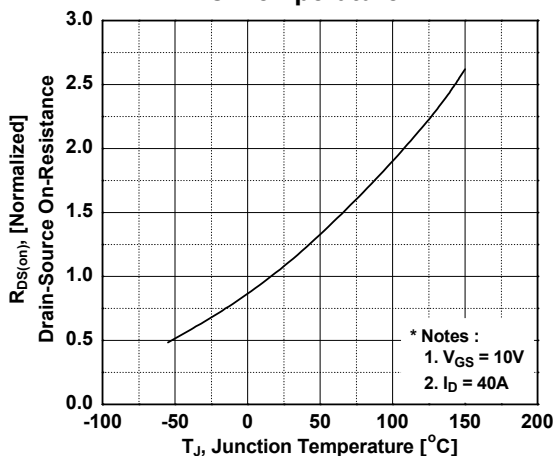

Figure 9. Maximum Safe Operating Area

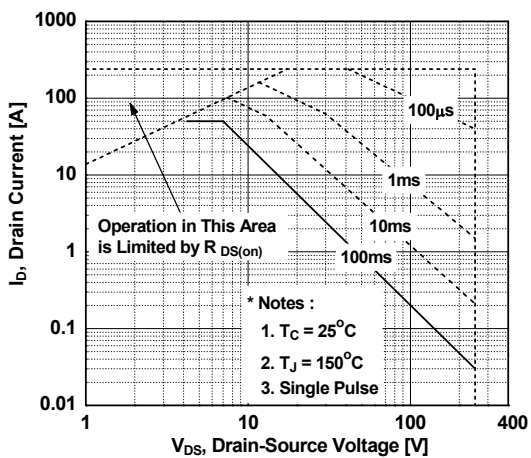

Figure 10. Maximum Drain Current vs. Case Temperature

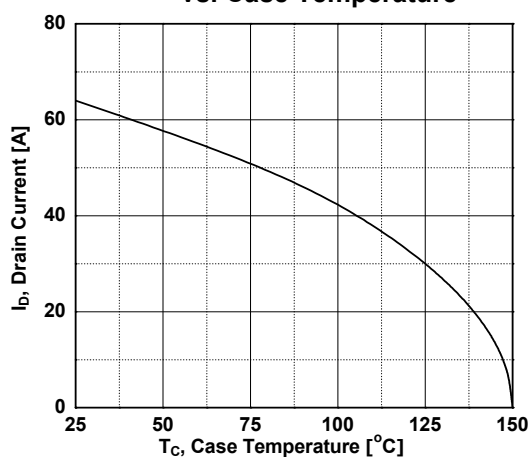
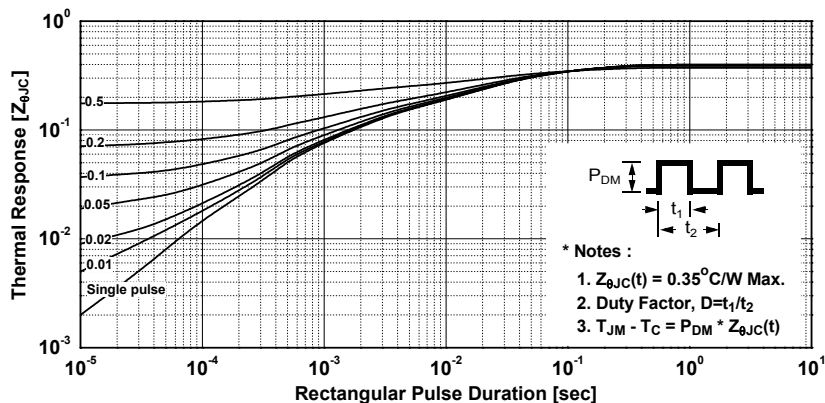
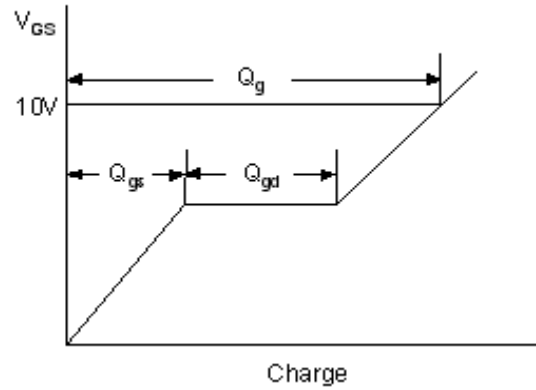
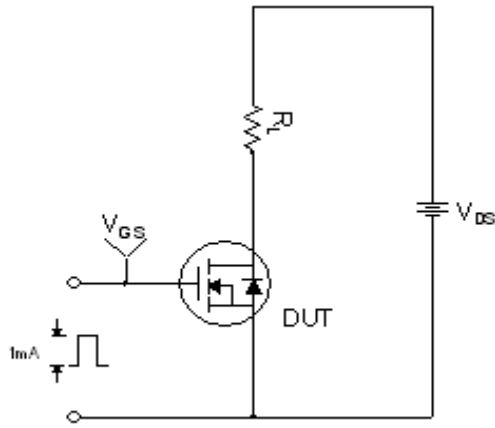

Figure 11. Transient Thermal Response Curve



Gate Charge Test Circuit & Waveform



Resistive Switching Test Circuit & Waveforms

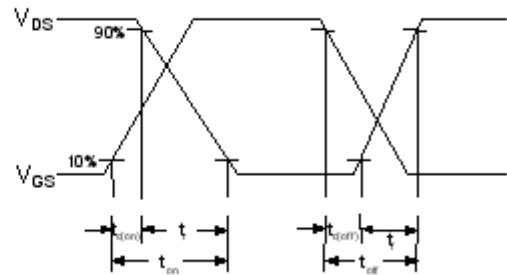
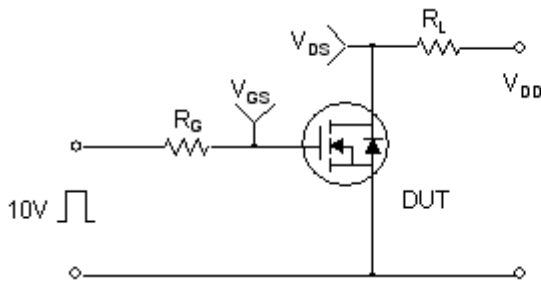

Unclamped Inductive Switching Test Circuit & Waveforms

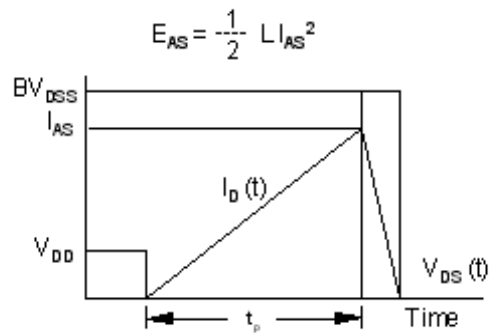
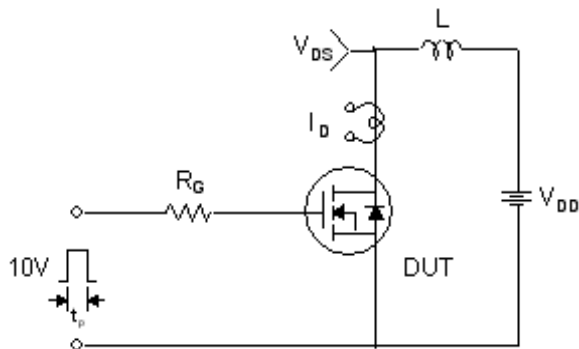

Peak Diode Recovery dv/dt Test Circuit & Waveforms

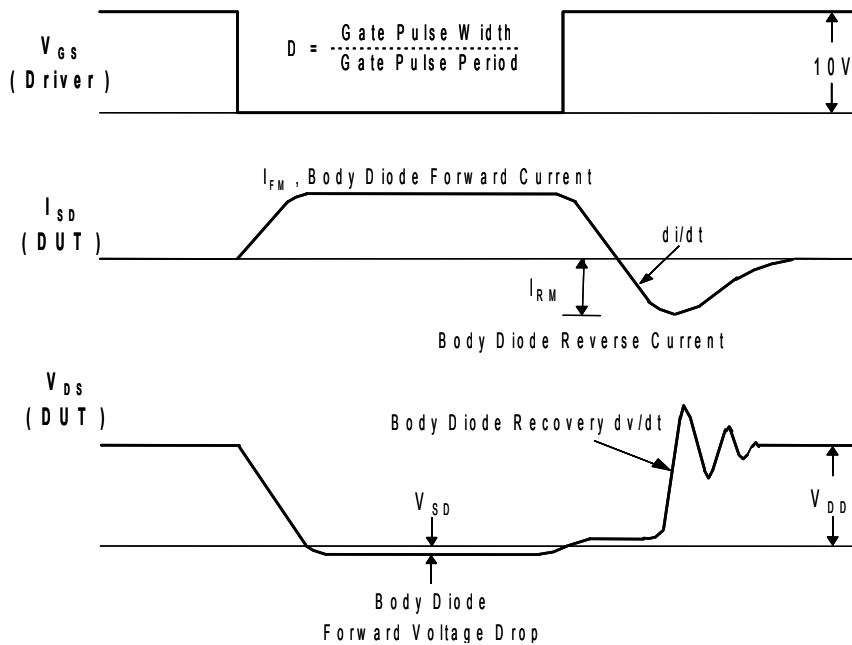
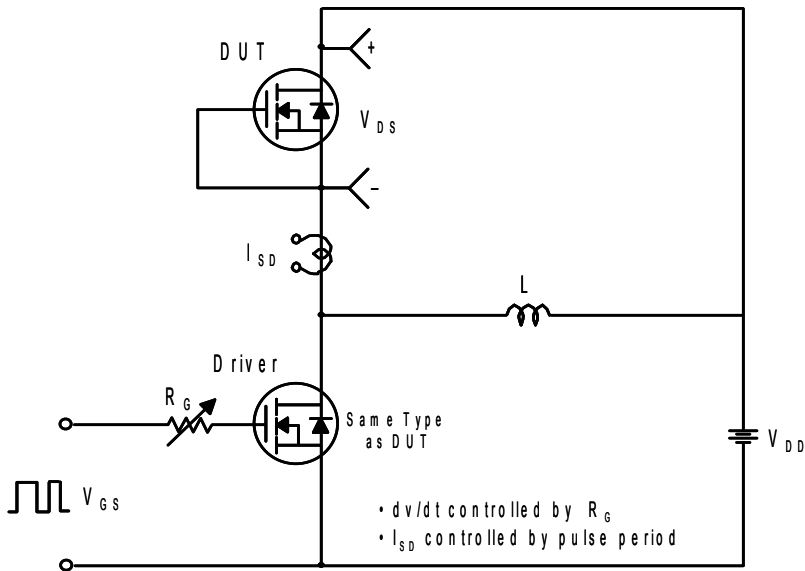

Mechanical Dimensions

TO-3PN

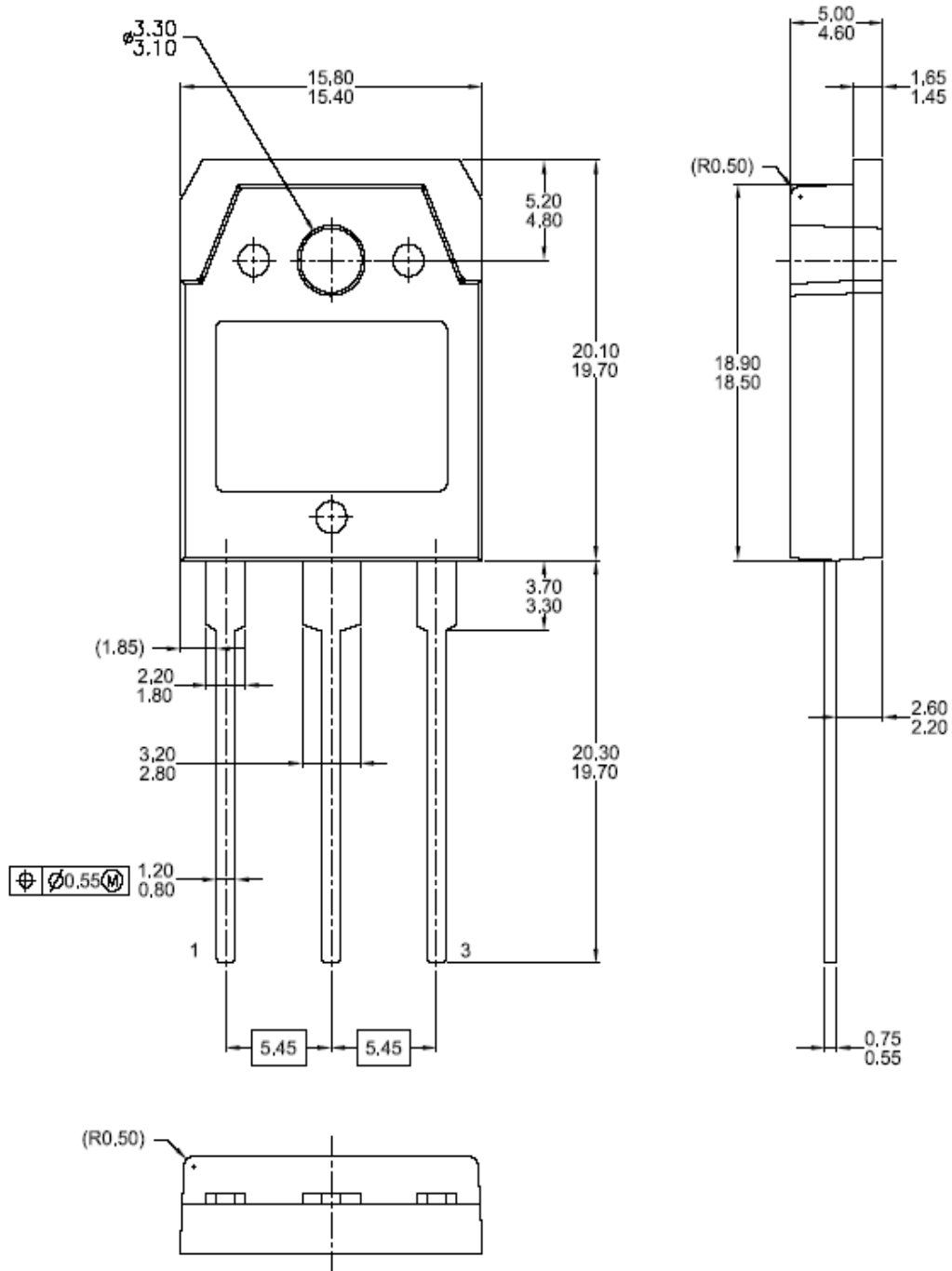

FDA2712 N-Channel UltraFET Trench MOSFET



TRADEMARKS

The following are registered and unregistered trademarks Fairchild Semiconductor owns or is authorized to use and is not intended to be an exhaustive list of all such trademarks.

- | | | | |
|--|--------------------------------|---|-----------------------------|
| ACEx [®] | HiSeC [™] | PowerSaver [™] | TinyBoost [™] |
| Across the board. Around the world. [™] | <i>i-Lo</i> [™] | PowerTrench [®] | TinyBuck [™] |
| ActiveArray [™] | ImpliedDisconnect [™] | Programmable Active Droop [™] | TinyLogic [®] |
| Bottomless [™] | IntelliMAX [™] | QFET [®] | TINYOPTO [™] |
| Build it Now [™] | ISOPLANAR [™] | QS [™] | TinyPower [™] |
| CoolFET [™] | MICROCOUPLER [™] | QT Optoelectronics [™] | TinyWire [™] |
| CROSSVOLT [™] | MicroPak [™] | Quiet Series [™] | TruTranslation [™] |
| CTL [™] | MICROWIRE [™] | RapidConfigure [™] | μSerDes [™] |
| Current Transfer Logic [™] | Motion-SPM [™] | RapidConnect [™] | UHC [®] |
| DOME [™] | MSX [™] | ScalarPump [™] | UniFET [™] |
| E ² CMOS [™] | MSXPro [™] | SMART START [™] | VCX [™] |
| EcoSPARK [®] | OCX [™] | SPM [®] | Wire [™] |
| EnSigna [™] | OCXPro [™] | STEALTH [™] | |
| FACT Quiet Series [™] | OPTOLOGIC [®] | SuperFET [™] | |
| FACT [®] | OPTOPLANAR [®] | SuperSOT [™] -3 | |
| FAST [®] | PACMAN [™] | SuperSOT [™] -6 | |
| FASTr [™] | PDP-SPM [™] | SuperSOT [™] -8 | |
| FPS [™] | POP [™] | SyncFET [™] | |
| FRFET [®] | Power220 [®] | TCM [™] | |
| GlobalOptoisolator [™] | Power247 [®] | The Power Franchise [®] | |
| GTO [™] | PowerEdge [™] |  | |

DISCLAIMER

FAIRCHILD SEMICONDUCTOR RESERVES THE RIGHT TO MAKE CHANGES WITHOUT FURTHER NOTICE TO ANY PRODUCTS HEREIN TO IMPROVE RELIABILITY, FUNCTION OR DESIGN. FAIRCHILD DOES NOT ASSUME ANY LIABILITY ARISING OUT OF THE APPLICATION OR USE OF ANY PRODUCT OR CIRCUIT DESCRIBED HEREIN; NEITHER DOES IT CONVEY ANY LICENSE UNDER ITS PATENT RIGHTS, NOR THE RIGHTS OF OTHERS. THESE SPECIFICATIONS DO NOT EXPAND THE TERMS OF FAIRCHILD'S WORLDWIDE TERMS AND CONDITIONS, SPECIFICALLY THE WARRANTY THEREIN, WHICH COVERS THESE PRODUCTS.

LIFE SUPPORT POLICY

FAIRCHILD'S PRODUCTS ARE NOT AUTHORIZED FOR USE AS CRITICAL COMPONENTS IN LIFE SUPPORT DEVICES OR SYSTEMS WITHOUT THE EXPRESS WRITTEN APPROVAL OF FAIRCHILD SEMICONDUCTOR CORPORATION.

As used herein:

- | | |
|---|---|
| <p>1. Life support devices or systems are devices or systems which, (a) are intended for surgical implant into the body or (b) support or sustain life, and (c) whose failure to perform when properly used in accordance with instructions for use provided in the labeling, can be reasonably expected to result in a significant injury of the user.</p> | <p>2. A critical component in any component of a life support, device, or system whose failure to perform can be reasonably expected to cause the failure of the life support device or system, or to affect its safety or effectiveness.</p> |
|---|---|

PRODUCT STATUS DEFINITIONS

Definition of Terms

Datasheet Identification	Product Status	Definition
Advance Information	Formative or In Design	This datasheet contains the design specifications for product development. Specifications may change in any manner without notice.
Preliminary	First Production	This datasheet contains preliminary data; supplementary data will be published at a later date. Fairchild Semiconductor reserves the right to make changes at any time without notice to improve design.
No Identification Needed	Full Production	This datasheet contains final specifications. Fairchild Semiconductor reserves the right to make changes at any time without notice to improve design.
Obsolete	Not In Production	This datasheet contains specifications on a product that has been discontinued by Fairchild Semiconductor. The datasheet is printed for reference information only.

Rev. I25