

FDC855N

Single N-Channel, Logic Level, PowerTrench® MOSFET 30V, 6.1A, 27mΩ

Features

- Max $r_{DS(on)}$ = 27mΩ at $V_{GS} = 10V$, $I_D = 6.1A$
- Max $r_{DS(on)}$ = 36mΩ at $V_{GS} = 4.5V$, $I_D = 5.3A$
- SuperSOT™ -6 package: small footprint (72% smaller than standard SO-8; low profile (1mm thick).
- RoHS Compliant



General Description

This N-Channel Logic Level MOSFET is an efficient solution for low voltage and battery powered applications. Utilizing Fairchild Semiconductor's advanced PowerTrench® process, this device possesses minimized on-state resistance to optimize the power consumption. They are ideal for applications where in-line power loss is critical.

Application

- Power Management in Notebook, Hard Disk Drive

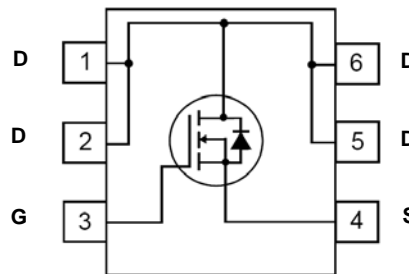
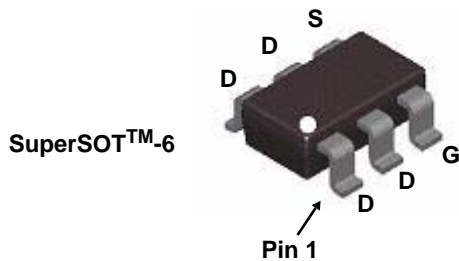

MOSFET Maximum Ratings $T_A = 25^\circ\text{C}$ unless otherwise noted

Symbol	Parameter	Ratings	Units
V_{DS}	Drain to Source Voltage	30	V
V_{GS}	Gate to Source Voltage	± 20	V
I_D	Drain Current -Continuous $T_A = 25^\circ\text{C}$ (Note 1a)	6.1	A
	-Pulsed	20	
P_D	Power Dissipation (Steady State) (Note 1a)	1.6	W
	Power Dissipation (Steady State) (Note 1b)	0.8	
T_J, T_{STG}	Operating and Storage Junction Temperature Range	-55 to +150	$^\circ\text{C}$

Thermal Characteristics

$R_{\theta JC}$	Thermal Resistance, Junction to Case (Note 1)	30	$^\circ\text{C/W}$
$R_{\theta JA}$	Thermal Resistance, Junction to Ambient (Note 1a)	78	

Package Marking and Ordering Information

Device Marking	Device	Package	Reel Size	Tape Width	Quantity
.855	FDC855N	SuperSOT-6	7"	8 mm	3000 units

Electrical Characteristics $T_J = 25^\circ\text{C}$ unless otherwise noted

Symbol	Parameter	Test Conditions	Min	Typ	Max	Units
BV_{DSS}	Drain to Source Breakdown Voltage	$I_D = 250\mu\text{A}, V_{GS} = 0\text{V}$	30			V
$\frac{\Delta BV_{DSS}}{\Delta T_J}$	Breakdown Voltage Temperature Coefficient	$I_D = 250\mu\text{A}$, referenced to 25°C		24		mV/ $^\circ\text{C}$
I_{DSS}	Zero Gate Voltage Drain Current	$V_{GS} = 0\text{V}, V_{DS} = 24\text{V}$, $T_C = 125^\circ\text{C}$			1 250	μA
I_{GSS}	Gate to Source Leakage Current	$V_{GS} = \pm 20\text{V}, V_{DS} = 0\text{V}$			± 100	nA

On Characteristics

$V_{GS(th)}$	Gate to Source Threshold Voltage	$V_{GS} = V_{DS}, I_D = 250\mu\text{A}$	1.0	2.0	3.0	V
$\frac{\Delta V_{GS(th)}}{\Delta T_J}$	Gate to Source Threshold Voltage Temperature Coefficient	$I_D = 250\mu\text{A}$, referenced to 25°C		-6		mV/ $^\circ\text{C}$
$r_{DS(on)}$	Static Drain to Source On Resistance	$V_{GS} = 10\text{V}, I_D = 6.1\text{A}$		20.7	27.0	m Ω
		$V_{GS} = 4.5\text{V}, I_D = 5.3\text{A}$		28.2	36.0	
		$V_{GS} = 10\text{V}, I_D = 6.1\text{A}, T_J = 125^\circ\text{C}$		30.1	39.3	
g_{FS}	Forward Transconductance	$V_{DD} = 10\text{V}, I_D = 6.1\text{A}$		20		S

Dynamic Characteristics

C_{iss}	Input Capacitance	$V_{DS} = 15\text{V}, V_{GS} = 0\text{V}$, $f = 1\text{MHz}$		493	655	pF
C_{oss}	Output Capacitance			108	145	pF
C_{rss}	Reverse Transfer Capacitance			62	95	pF
R_g	Gate Resistance	$f = 1\text{MHz}$		1.0		Ω

Switching Characteristics

$t_{d(on)}$	Turn-On Delay Time	$V_{DD} = 15\text{V}, I_D = 6.1\text{A}$, $V_{GS} = 10\text{V}, R_{GEN} = 6\Omega$		6	12	ns
t_r	Rise Time			2	10	ns
$t_{d(off)}$	Turn-Off Delay Time			14	23	ns
t_f	Fall Time			2	10	ns
Q_g	Total Gate Charge at 10V		$V_{GS} = 0\text{V to } 10\text{V}$	$V_{DD} = 15\text{V}$, $I_D = 6.1\text{A}$	9.2	13
Q_g	Total Gate Charge at 5V	$V_{GS} = 0\text{V to } 5\text{V}$	4.9		7.0	nC
Q_{gs}	Gate to Source Charge		1.7			nC
Q_{gd}	Gate to Drain "Miller" Charge		3.1			nC

Drain-Source Diode Characteristics

V_{SD}	Source to Drain Diode Forward Voltage	$V_{GS} = 0\text{V}, I_S = 1.3\text{A}$ (Note 2)		0.80	1.2	V
t_{rr}	Reverse Recovery Time	$I_F = 6.1\text{A}, di/dt = 100\text{A}/\mu\text{s}$		17	31	ns
Q_{rr}	Reverse Recovery Charge			6	12	nC

Notes:

1: $R_{\theta JA}$ is the sum of the junction-to-case and case-to-ambient thermal resistance where the case thermal reference is defined as the solder mounting surface of the drain pins. $R_{\theta JC}$ is guaranteed by design while $R_{\theta CA}$ is determined by the user's board design.



a. 78°C/W when mounted on a 1 in^2 pad of 2 oz copper.



b. 156°C/W when mounted on a minimum pad of 2 oz copper.

2: Pulse Test: Pulse Width < 300 μs , Duty Cycle < 2.0%.

Typical Characteristics $T_J = 25^\circ\text{C}$ unless otherwise noted

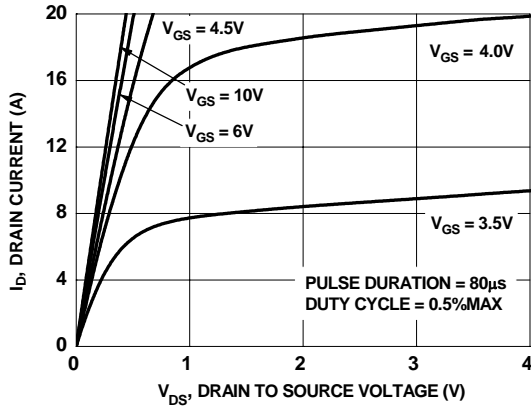

Figure 1. On-Region Characteristics

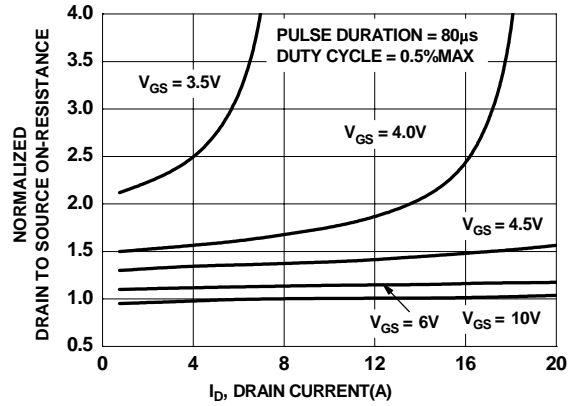

Figure 2. Normalized On-Resistance vs Drain Current and Gate Voltage

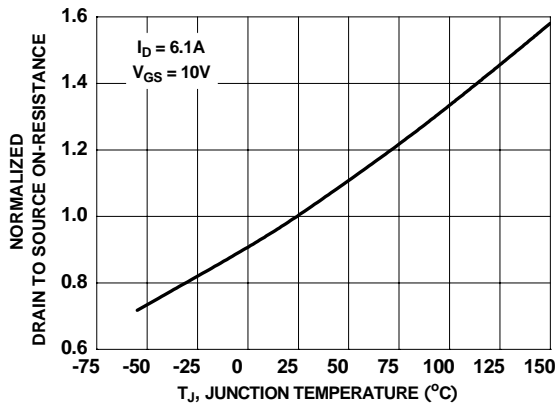

Figure 3. Normalized On-Resistance vs Junction Temperature

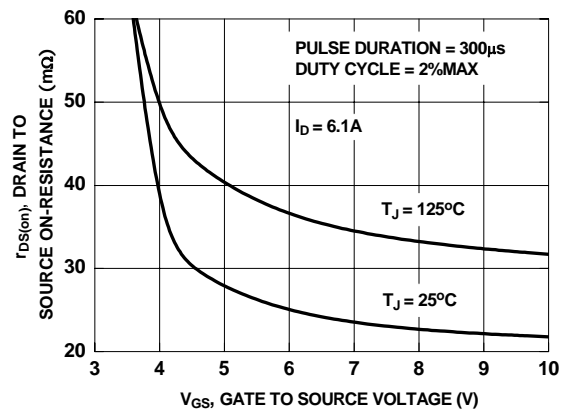

Figure 4. On-Resistance vs Gate to Source Voltage

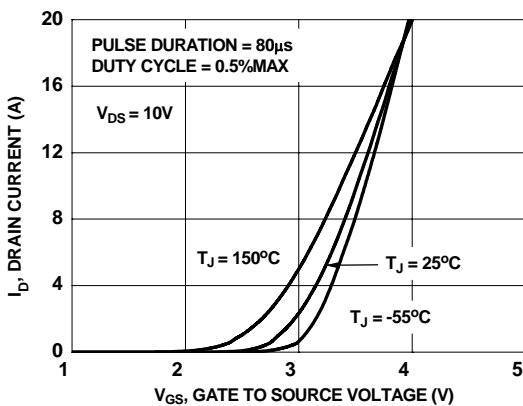

Figure 5. Transfer Characteristics

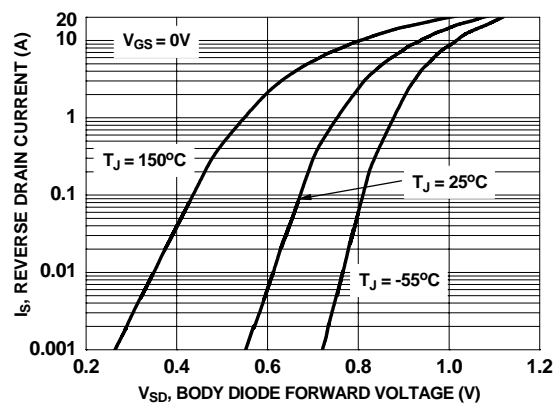

Figure 6. Source to Drain Diode Forward Voltage vs Source Current

Typical Characteristics $T_J = 25^\circ\text{C}$ unless otherwise noted

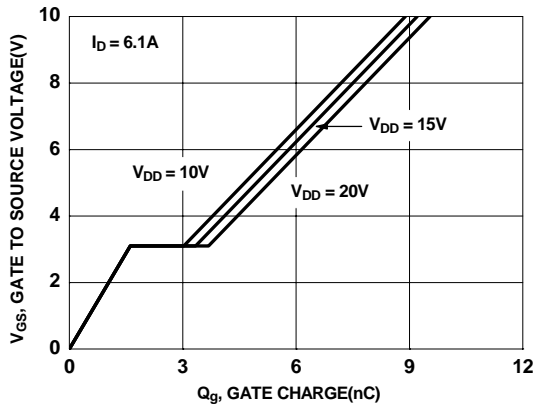

Figure 7. Gate Charge Characteristics

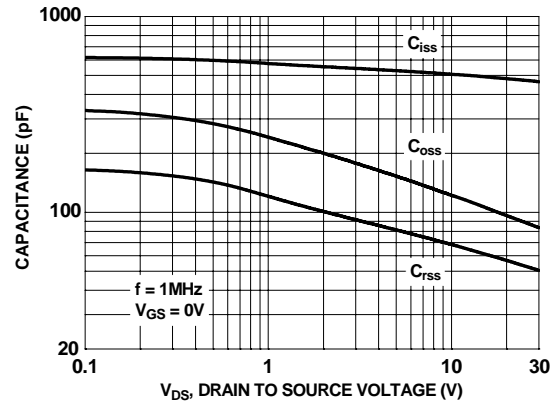

Figure 8. Capacitance vs Drain to Source Voltage

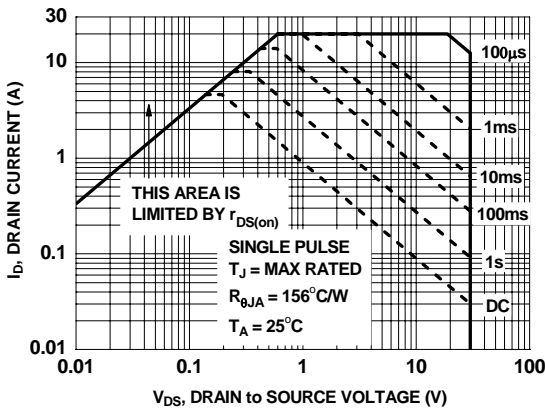

Figure 9. Forward Bias Safe Operating Area

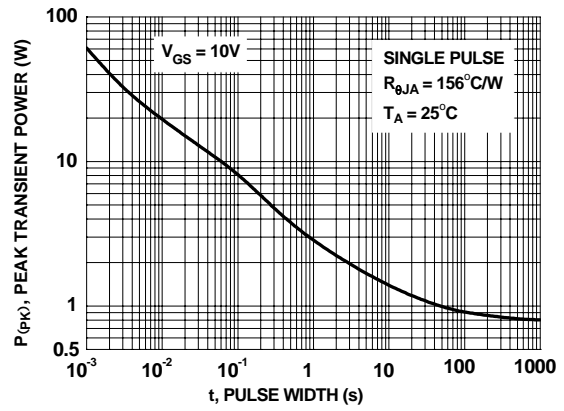

Figure 10. Single Pulse Maximum Power Dissipation

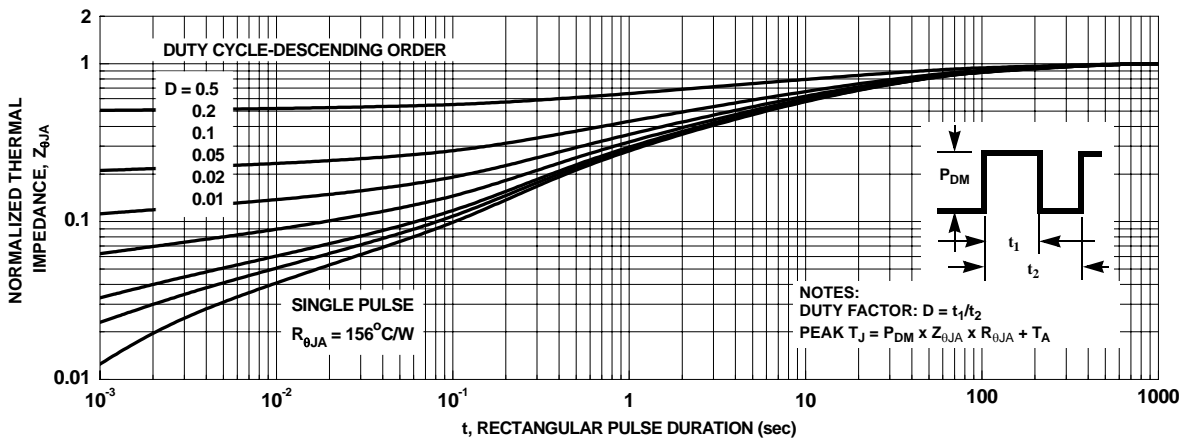
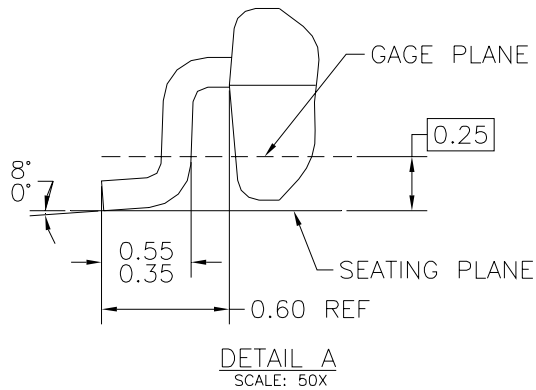
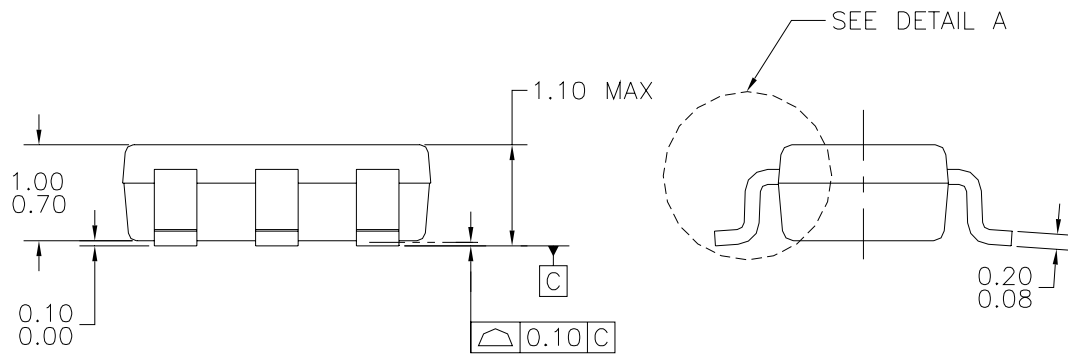
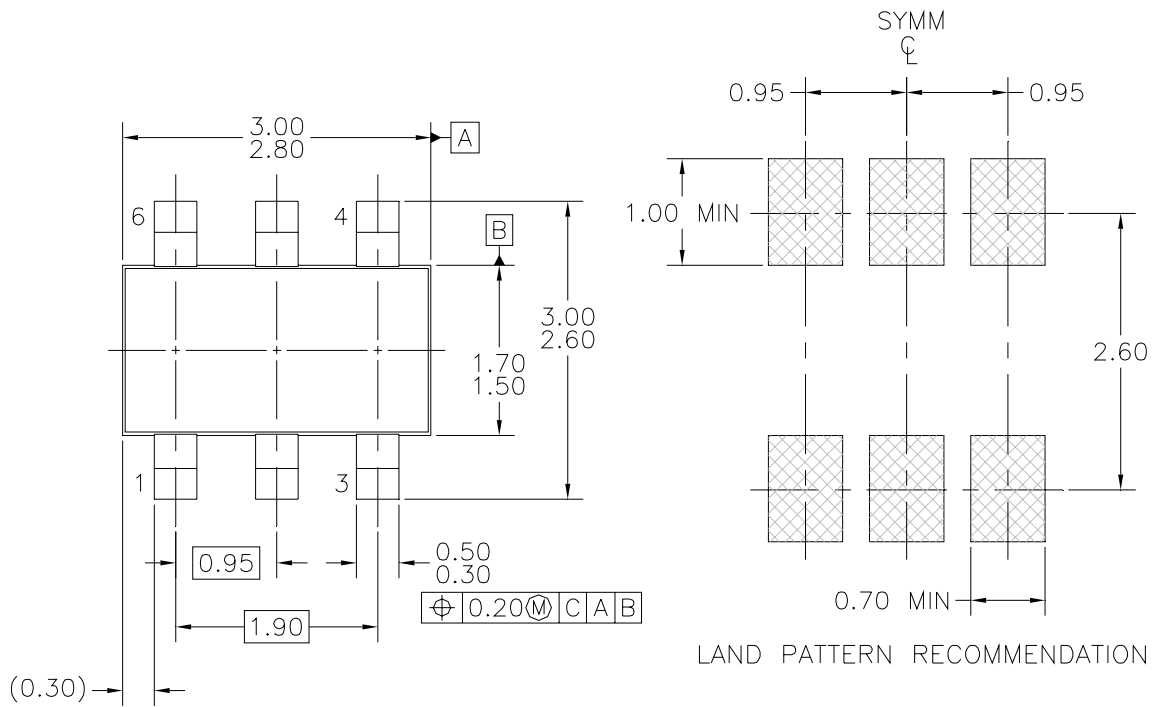

Figure 11. Transient Thermal Response Curve

Dimensional Outline and Pad Layout



NOTES: UNLESS OTHERWISE SPECIFIED

- A) THIS PACKAGE CONFORMS TO JEDEC MO-193. VAR. AA, ISSUE C, DATED JANUARY 2000.
- B) ALL DIMENSIONS ARE IN MILLIMETERS.

MA06AREVD



TRADEMARKS

The following includes registered and unregistered trademarks and service marks, owned by Fairchild Semiconductor and/or its global subsidiaries, and is not intended to be an exhaustive list of all such trademarks.

- | | | | |
|--------------------------|-------------------------------------|----------------------------|----------------------|
| ACEx® | FPS™ | PDP-SPM™ | SupreMOS™ |
| Build it Now™ | FRFET® | Power220® | SyncFET™ |
| CorePLUS™ | Global Power Resource SM | POWEREDGE® | SYSTEM GENERAL® |
| CROSSVOLT™ | Green FPS™ | Power-SPM™ | The Power Franchise® |
| CTL™ | Green FPS™ e-Series™ | PowerTrench® | the power franchise |
| Current Transfer Logic™ | GTO™ | Programmable Active Droop™ | TinyBoost™ |
| EcoSPARK® | <i>i-Lo</i> ™ | QFET® | TinyBuck™ |
| EZSWITCH™ * | IntelliMAX™ | QS™ | TinyLogic® |
| EZ | ISOPLANAR™ | QT Optoelectronics™ | TINYOPTO™ |
| F | MegaBuck™ | Quiet Series™ | TinyPower™ |
| Fairchild® | MICROCOUPLER™ | RapidConfigure™ | TinyPWM™ |
| Fairchild Semiconductor® | MicroFET™ | SMART START™ | TinyWire™ |
| FACT Quiet Series™ | MicroPak™ | SPM® | µSerDes™ |
| FACT® | MillerDrive™ | STEALTH™ | UHC® |
| FAST® | Motion-SPM™ | SuperFET™ | Ultra FRFET™ |
| FastvCore™ | OPTOLOGIC® | SuperSOT™-3 | UniFET™ |
| FlashWriter® * | OPTOPLANAR® | SuperSOT™-6 | VCX™ |
| | | SuperSOT™-8 | |

* EZSWITCH™ and FlashWriter® are trademarks of System General Corporation, used under license by Fairchild Semiconductor.

DISCLAIMER

FAIRCHILD SEMICONDUCTOR RESERVES THE RIGHT TO MAKE CHANGES WITHOUT NOTICE TO ANY PRODUCTS HEREIN TO IMPROVE RELIABILITY, FUNCTION, OR DESIGN. FAIRCHILD DOES NOT ASSUME ANY LIABILITY ARISING OUT OF THE APPLICATION OR USE OF ANY PRODUCT OR CIRCUIT DESCRIBED HEREIN; NEITHER DOES IT CONVEY ANY LICENSE UNDER ITS PATENT RIGHTS, NOR THE RIGHTS OF OTHERS. THESE SPECIFICATIONS DO NOT EXPAND THE TERMS OF FAIRCHILD'S WORLDWIDE TERMS AND CONDITIONS, SPECIFICALLY THE WARRANTY THEREIN, WHICH COVERS THESE PRODUCTS.

LIFE SUPPORT POLICY

FAIRCHILD'S PRODUCTS ARE NOT AUTHORIZED FOR USE AS CRITICAL COMPONENTS IN LIFE SUPPORT DEVICES OR SYSTEMS WITHOUT THE EXPRESS WRITTEN APPROVAL OF FAIRCHILD SEMICONDUCTOR CORPORATION.

As used herein:

- Life support devices or systems are devices or systems which, (a) are intended for surgical implant into the body or (b) support or sustain life, and (c) whose failure to perform when properly used in accordance with instructions for use provided in the labeling, can be reasonably expected to result in a significant injury to the user.
- A critical component in any component of a life support, device or system whose failure to perform can be reasonably expected to cause the failure of the life support device or system, or to affect its safety or effectiveness.

PRODUCT STATUS DEFINITIONS

Definition of Terms

Datasheet Identification	Product Status	Definition
Advance Information	Formative or In Design	This datasheet contains the design specifications for product development. Specifications may change in any manner without notice.
Preliminary	First Production	This datasheet contains preliminary data; supplementary data will be published at a later date. Fairchild Semiconductor reserves the right to make changes at any time without notice to improve design.
No Identification Needed	Full Production	This datasheet contains final specifications. Fairchild Semiconductor reserves the right to make changes at any time without notice to improve design.
Obsolete	Not In Production	This datasheet contains specifications on a product that has been discontinued by Fairchild Semiconductor. The datasheet is printed for reference information only.