

MOSFET – N-Channel, POWERTRENCH[®], SyncFET[™]

25 V, 40 A, 2 mΩ

FDMC7570S

General Description

The FDMC7570S has been designed to minimize losses in power conversion application. Advancements in both silicon and package technologies have been combined to offer the lowest $R_{DS(on)}$ while maintaining excellent switching performance. This device has the added benefit of an efficient monolithic Schottky body diode.

Features

- Max $R_{DS(on)}$ = 2 mΩ at $V_{GS} = 10\text{ V}$, $I_D = 27\text{ A}$
- Max $R_{DS(on)}$ = 2.9 mΩ at $V_{GS} = 4.5\text{ V}$, $I_D = 21.5\text{ A}$
- Advanced Package and Combination for Low $R_{DS(on)}$ and High Efficiency
- SyncFET Schottky Body Diode
- 100% UIL Tested
- These Devices are Pb-Free and are RoHS Compliant

Applications

- Synchronous Rectifier for DC/DC Converters
- Notebook Vcore/GPU Low Side Switch
- Networking Point of Load Low Side Switch
- Telecom Secondary Side Rectification

MAXIMUM RATINGS ($T_A = 25^\circ\text{C}$ unless otherwise noted)

Parameter	Symbol	Rating	Unit
Drain to Source Voltage	V_{DS}	25	V
Gate to Source Voltage (Note 4)	V_{GS}	±20	V
Drain Current	I_D		A
– Continuous (Package limited) $T_C = 25^\circ\text{C}$		40	
– Continuous (Silicon limited) $T_C = 25^\circ\text{C}$		132	
– Continuous $T_A = 25^\circ\text{C}$ (Note 1a)		27	
– Pulsed		120	
Single Pulse Avalanche Energy (Note 3)	E_{AS}	144	mJ
Power Dissipation $T_C = 25^\circ\text{C}$	P_D	59	W
Power Dissipation $T_A = 25^\circ\text{C}$ (Note 1a)		2.3	
Operating and Storage Junction Temperature Range	T_J, T_{STG}	–55 to +150	°C

Stresses exceeding those listed in the Maximum Ratings table may damage the device. If any of these limits are exceeded, device functionality should not be assumed, damage may occur and reliability may be affected.

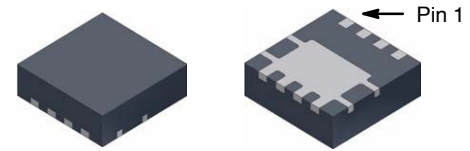

Power 33
PQFN8
CASE 483AK

PIN ASSIGNMENT

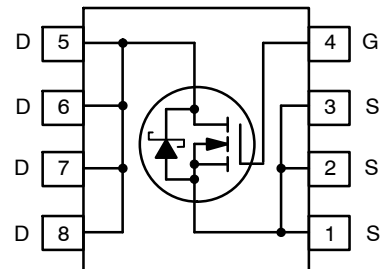

MARKING DIAGRAM

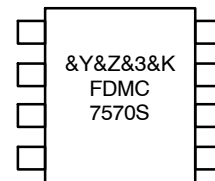

&Y = onsemi Logo
&Z = Assembly Plant Code
&3 = 3-Digit Data Code
&K = 2-Digit Lot Traceability Code
FDMC7570S = Specific Device Code

ORDERING INFORMATION

Device	Package	Shipping [†]
FDMC7570S	PQFN8 (Pb-Free)	3,000 / Tape & Reel

[†]For information on tape and reel specifications, including part orientation and tape sizes, please refer to our Tape and Reel Packaging Specification Brochure, BRD8011/D.

FDMC7570S

THERMAL CHARACTERISTICS

Rating	Symbol	Value	Unit
Thermal Resistance, Junction to Case	$R_{\theta JC}$	2.1	$^{\circ}C/W$
Thermal Resistance, Junction to Ambient (Note 1a)	$R_{\theta JA}$	53	

ELECTRICAL CHARACTERISTICS ($T_J = 25^{\circ}C$ unless otherwise specified)

Parameter	Test Conditions	Symbol	Min	Typ	Max	Unit
OFF CHARACTERISTIC						
Drain to Source Breakdown Voltage	$I_D = 1 \text{ mA}, V_{GS} = 0 \text{ V}$	BV_{DSS}	25			V
Breakdown Voltage Temperature Coefficient	$I_D = 10 \text{ mA}$, referenced to $25^{\circ}C$	$\Delta BV_{DSS} / \Delta T_J$		21		$mV/^{\circ}C$
Zero Gate Voltage Drain Current	$V_{DS} = 20 \text{ V}, V_{GS} = 0 \text{ V}$	I_{DSS}			500	μA
Gate to Source Leakage Current, Forward	$V_{GS} = 20 \text{ V}, V_{DS} = 0 \text{ V}$	I_{GSS}			100	nA

ON CHARACTERISTICS

Gate to Source Threshold Voltage	$V_{GS} = V_{DS}, I_D = 1 \text{ mA}$	$V_{GS(th)}$	1.2	1.7	3	V
Gate to Source Threshold Voltage Temperature Coefficient	$I_D = 10 \text{ mA}$, referenced to $25^{\circ}C$	$\Delta V_{GS(th)} / \Delta T_J$		-4		$mV/^{\circ}C$
Static Drain to Source On Resistance	$V_{GS} = 10 \text{ V}, I_D = 27 \text{ A}$	$R_{DS(on)}$		1.6	2	m Ω
	$V_{GS} = 4.5 \text{ V}, I_D = 21.5 \text{ A}$			2.4	2.9	
	$V_{GS} = 10 \text{ V}, I_D = 27 \text{ A}, T_J = 125^{\circ}C$			2.2	2.8	
Forward Transconductance	$V_{DS} = 5 \text{ V}, I_D = 27 \text{ A}$	g_{FS}		154		S

DYNAMIC CHARACTERISTICS

Input Capacitance	$V_{DS} = 13 \text{ V}, V_{GS} = 0 \text{ V}, f = 1 \text{ MHz}$	C_{iss}		3315	4410	pF
Output Capacitance		C_{oss}		1010	1345	pF
Reverse Transfer Capacitance		C_{rss}		168	255	pF
Gate Resistance		R_g		1.2	2.1	Ω

SWITCHING CHARACTERISTICS

Turn-On Delay Time	$V_{DD} = 13 \text{ V}, I_D = 27 \text{ A}, V_{GS} = 10 \text{ V}, R_{GEN} = 6 \Omega$	$t_{d(on)}$		14	26	ns
Rise Time		t_r		6.8	14	ns
Turn-Off Delay Time		$t_{d(off)}$		34	55	ns
Fall Time		t_f		4.5	10	ns
Total Gate Charge	$V_{GS} = 0 \text{ V to } 10 \text{ V}, V_{DD} = 13 \text{ V}$	$Q_{g(TOT)}$		49	68	nC
Total Gate Charge	$V_{GS} = 0 \text{ V to } 4.5 \text{ V}, V_{DD} = 13 \text{ V}$	$Q_{g(TOT)}$		22	31	nC
Gate to Source Gate Charge	$I_D = 27 \text{ A}$	Q_{gs}		10.8		nC
Gate to Drain "Miller" Charge		Q_{gd}		5.5		nC

DRAIN-SOURCE DIODE CHARACTERISTICS

Source to Drain Diode Forward Voltage	$V_{GS} = 0 \text{ V}, I_S = 27 \text{ A}$ (Note 2)	V_{SD}		0.78	1.2	V
	$V_{GS} = 0 \text{ V}, I_S = 2 \text{ A}$ (Note 2)			0.43	0.8	
Reverse Recovery Time	$I_F = 27 \text{ A}, di/dt = 300 \text{ A}/\mu s$	t_{rr}		30	48	ns
Reverse Recovery Charge		Q_{rr}		29	46	nC

Product parametric performance is indicated in the Electrical Characteristics for the listed test conditions, unless otherwise noted. Product performance may not be indicated by the Electrical Characteristics if operated under different conditions.

FDMC7570S

NOTES:

1. $R_{\theta JA}$ is determined with the device mounted on a 1 in² pad 2 oz copper pad on a 1.5 × 1.5 in. board of FR-4 material. $R_{\theta JC}$ is guaranteed by design while $R_{\theta CA}$ is determined by the user's board design.

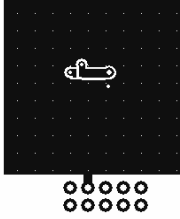

a) 53°C/W when mounted on a 1 in² pad of 2 oz copper.



b) 125°C/W when mounted on a minimum pad of 2 oz copper.

2. Pulse Test: Pulse Width < 300 μs, Duty cycle < 2.0%.
3. E_{AS} of 144 mJ is based on starting $T_J = 25^\circ\text{C}$, $L = 1$ mH, $I_{AS} = 17$ A, $V_{DD} = 23$ V, $V_{GS} = 10$ V. 100% test at $L = 0.3$ mH, $I_{AS} = 25$ A.
4. As an N-ch device, the negative V_{GS} rating is for lower duty cycle pulse occurrence only. No continuous rating is implied.

TYPICAL CHARACTERISTICS

($T_J = 25^\circ\text{C}$ unless otherwise noted)

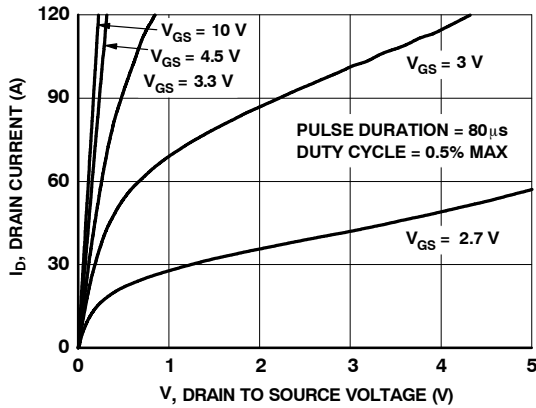

Figure 1. On-Region Characteristics

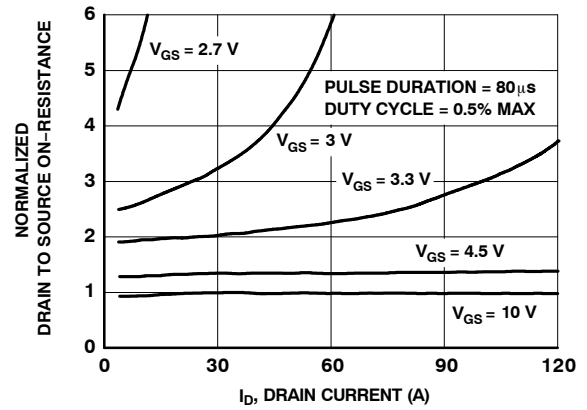

Figure 2. Normalized On-Resistance vs. Drain Current and Gate Voltage

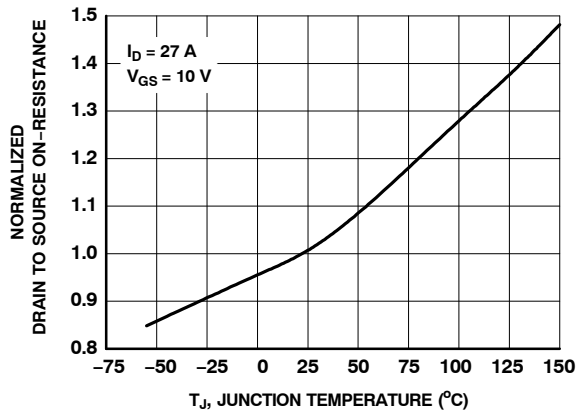

Figure 3. Normalized On-Resistance vs. Junction Temperature

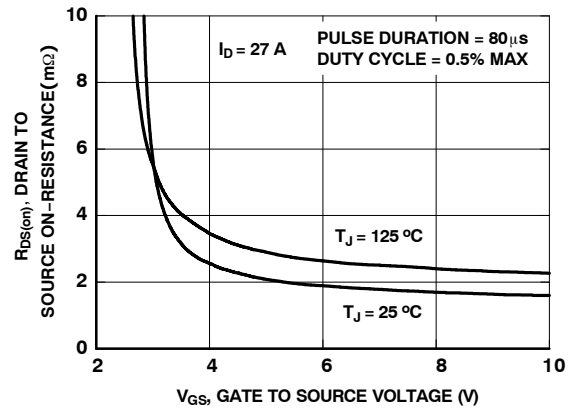

Figure 4. On-Resistance vs. Gate to Source Voltage

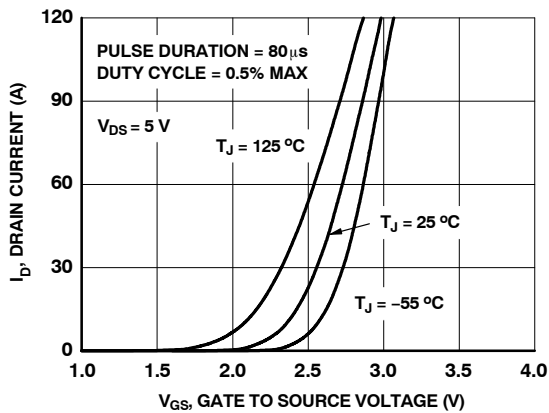

Figure 5. Transfer Characteristics

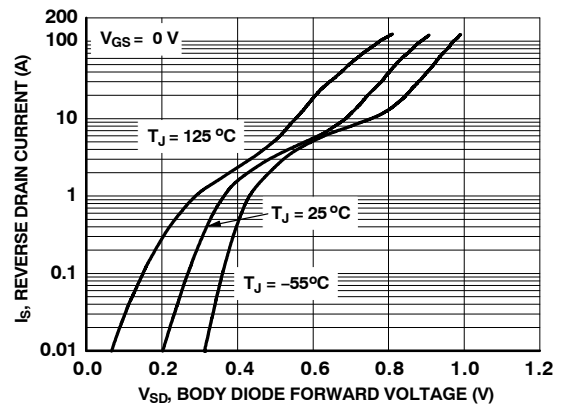

Figure 6. Source to Drain Diode Forward Voltage vs Source Current

FDMC7570S

TYPICAL CHARACTERISTICS (continued)

($T_J = 25^\circ\text{C}$ unless otherwise noted)

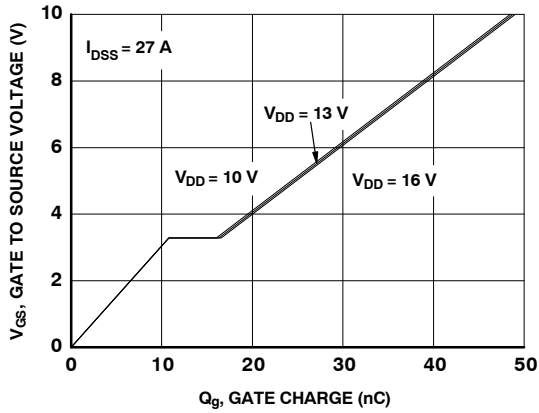

Figure 7. Gate Charge Characteristics

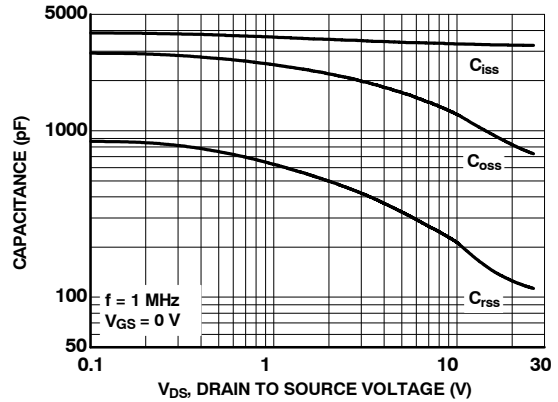

Figure 8. Capacitance vs Drain to Source Voltage

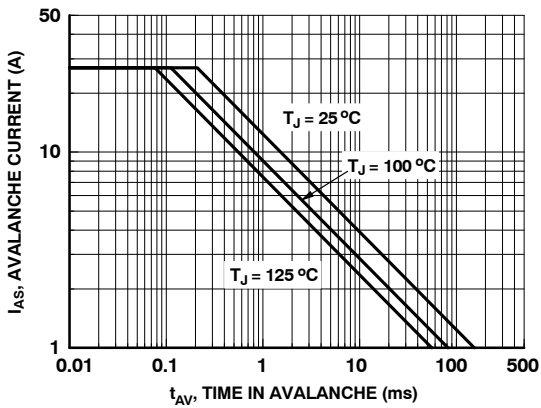

Figure 9. Unclamped Inductive Switching Capability

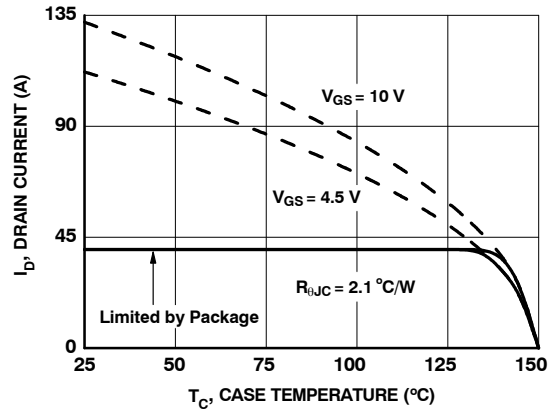

Figure 10. Maximum Continuous Drain Current vs Case Temperature

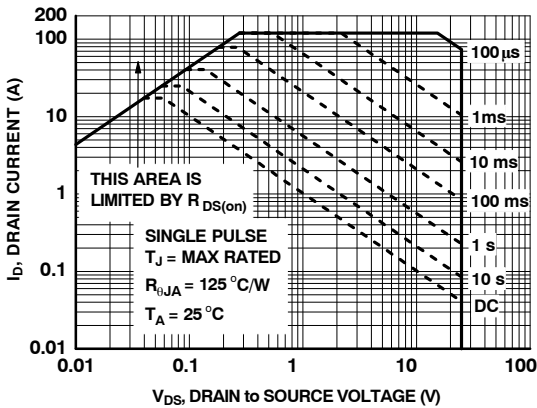

Figure 11. Forward Bias Safe Operating Area

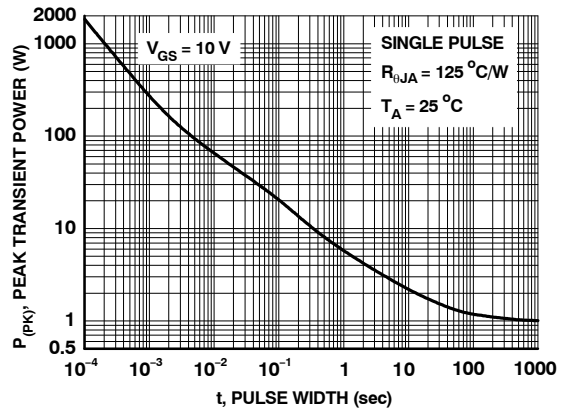

Figure 12. Single Pulse Maximum Power Dissipation

FDMC7570S

TYPICAL CHARACTERISTICS (continued)

($T_J = 25^\circ\text{C}$ unless otherwise noted)

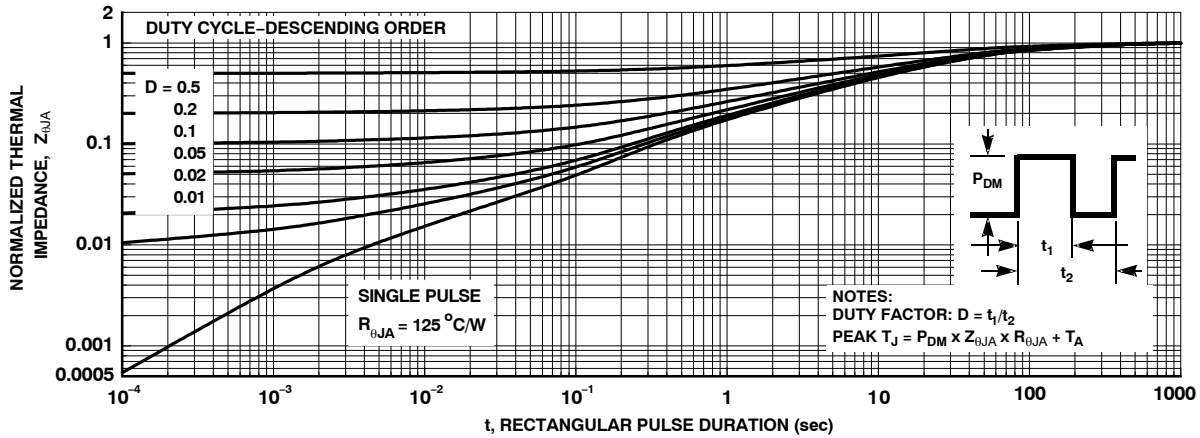

Figure 13. Junction-to-Ambient Transient Thermal Response Curve

SyncFET SCHOTTKY BODY DIODE CHARACTERISTICS

onsemi's SyncFET process embeds a Schottky diode in parallel with POWERTRENCH MOSFET. This diode exhibits similar characteristics to a discrete external Schottky diode in parallel with a MOSFET. Figure 14 shows the reverse recovery characteristic of the FDMC7570S.

Schottky barrier diodes exhibit significant leakage at high temperature and high reverse voltage. This will increase the power in the device.

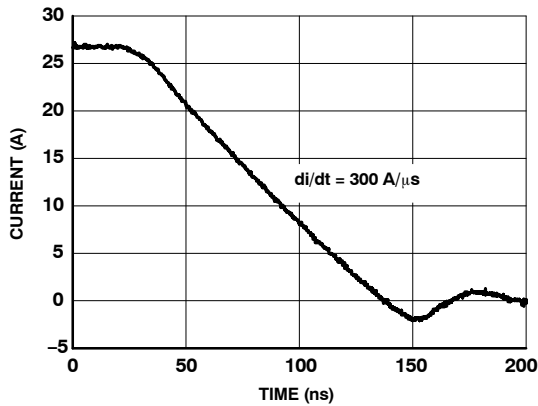

Figure 14. FDMC7570S SyncFET Body Diode Reverse Recovery Characteristic

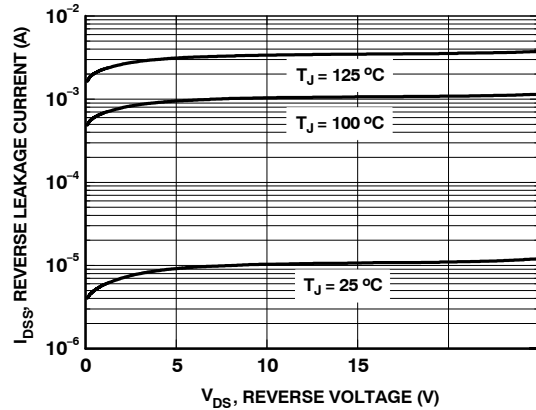
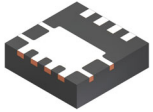

Figure 15. SyncFET Body Diode Reverse Leakage vs. Drain-Source Voltage

POWERTRENCH is a registered trademark and SyncFET is a trademark of Semiconductor Components Industries, LLC dba "onsemi" or its affiliates and/or subsidiaries in the United States and/or other countries.

MECHANICAL CASE OUTLINE

PACKAGE DIMENSIONS



PQFN8 3.3X3.3, 0.65P
CASE 483AK
ISSUE B

DATE 12 OCT 2021

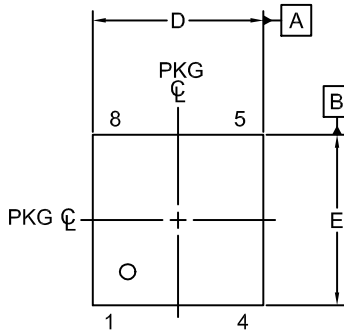

TOP VIEW

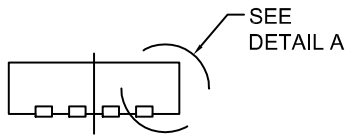

FRONT VIEW

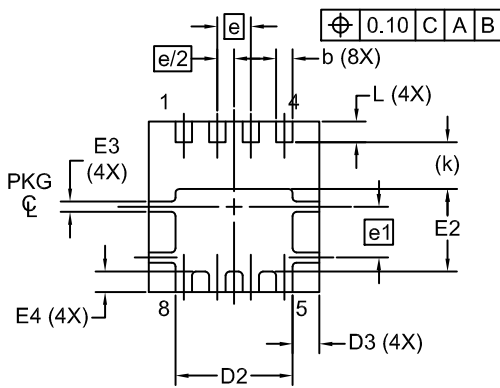

BOTTOM VIEW

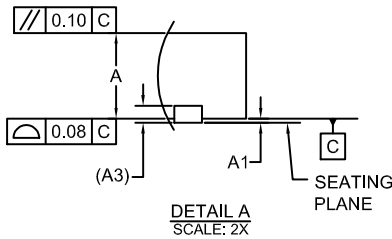

DETAIL A
SCALE: 2X

NOTES:

1. DIMENSIONING AND TOLERANCING PER ASME Y14.5M, 2009.
2. CONTROLLING DIMENSION: MILLIMETERS
3. COPLANARITY APPLIES TO THE EXPOSED PADS AS WELL AS THE TERMINALS.
4. DIMENSIONS D1 AND E1 DO NOT INCLUDE MOLD FLASH, PROTRUSIONS, OR GATE BURRS.
5. SEATING PLANE IS DEFINED BY THE TERMINALS. "A1" IS DEFINED AS THE DISTANCE FROM THE SEATING PLANE TO THE LOWEST POINT ON THE PACKAGE BODY.
6. IT IS RECOMMENDED TO HAVE NO TRACES OR VIAS WITHIN THE KEEP OUT AREA.

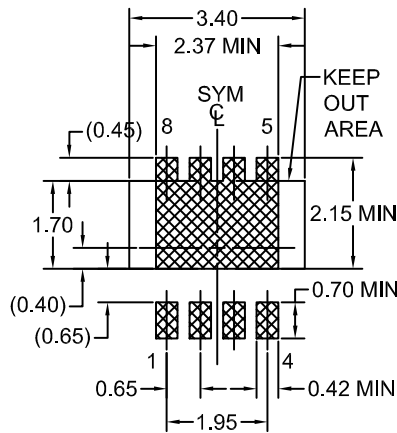

LAND PATTERN
RECOMMENDATION

*FOR ADDITIONAL INFORMATION ON OUR PB-FREE STRATEGY AND SOLDERING DETAILS, PLEASE DOWNLOAD THE ON SEMICONDUCTOR SOLDERING AND MOUNTING TECHNIQUES REFERENCE MANUAL, SOLDERM/D.

DIM	MILLIMETERS		
	MIN.	NOM.	MAX.
A	0.90	1.00	1.10
A1	0.00	-	0.05
A3	0.20 REF		
b	0.27	0.32	0.37
D	3.20	3.30	3.40
D2	2.17	2.27	2.37
D3	0.42	0.52	0.62
E	3.20	3.30	3.40
E2	1.50	1.60	1.70
E3	0.10	0.20	0.30
E4	0.29	0.39	0.49
e	0.65 BSC		
e/2	0.325 BSC		
e1	0.98 BSC		
k	0.91 REF		
L	0.30	0.40	0.50

DOCUMENT NUMBER:	98AON13660G	Electronic versions are uncontrolled except when accessed directly from the Document Repository. Printed versions are uncontrolled except when stamped "CONTROLLED COPY" in red.
DESCRIPTION:	PQFN8 3.3X3.3, 0.65P	PAGE 1 OF 1

onsemi and ONSEMI are trademarks of Semiconductor Components Industries, LLC dba onsemi or its subsidiaries in the United States and/or other countries. onsemi reserves the right to make changes without further notice to any products herein. onsemi makes no warranty, representation or guarantee regarding the suitability of its products for any particular purpose, nor does onsemi assume any liability arising out of the application or use of any product or circuit, and specifically disclaims any and all liability, including without limitation special, consequential or incidental damages. onsemi does not convey any license under its patent rights nor the rights of others.

onsemi, **Onsemi**, and other names, marks, and brands are registered and/or common law trademarks of Semiconductor Components Industries, LLC dba "**onsemi**" or its affiliates and/or subsidiaries in the United States and/or other countries. **onsemi** owns the rights to a number of patents, trademarks, copyrights, trade secrets, and other intellectual property. A listing of **onsemi**'s product/patent coverage may be accessed at www.onsemi.com/site/pdf/Patent-Marking.pdf. **onsemi** reserves the right to make changes at any time to any products or information herein, without notice. The information herein is provided "as-is" and **onsemi** makes no warranty, representation or guarantee regarding the accuracy of the information, product features, availability, functionality, or suitability of its products for any particular purpose, nor does **onsemi** assume any liability arising out of the application or use of any product or circuit, and specifically disclaims any and all liability, including without limitation special, consequential or incidental damages. Buyer is responsible for its products and applications using **onsemi** products, including compliance with all laws, regulations and safety requirements or standards, regardless of any support or applications information provided by **onsemi**. "Typical" parameters which may be provided in **onsemi** data sheets and/or specifications can and do vary in different applications and actual performance may vary over time. All operating parameters, including "Typicals" must be validated for each customer application by customer's technical experts. **onsemi** does not convey any license under any of its intellectual property rights nor the rights of others. **onsemi** products are not designed, intended, or authorized for use as a critical component in life support systems or any FDA Class 3 medical devices or medical devices with a same or similar classification in a foreign jurisdiction or any devices intended for implantation in the human body. Should Buyer purchase or use **onsemi** products for any such unintended or unauthorized application, Buyer shall indemnify and hold **onsemi** and its officers, employees, subsidiaries, affiliates, and distributors harmless against all claims, costs, damages, and expenses, and reasonable attorney fees arising out of, directly or indirectly, any claim of personal injury or death associated with such unintended or unauthorized use, even if such claim alleges that **onsemi** was negligent regarding the design or manufacture of the part. **onsemi** is an Equal Opportunity/Affirmative Action Employer. This literature is subject to all applicable copyright laws and is not for resale in any manner.

ADDITIONAL INFORMATION

TECHNICAL PUBLICATIONS:

Technical Library: www.onsemi.com/design/resources/technical-documentation
onsemi Website: www.onsemi.com

ONLINE SUPPORT: www.onsemi.com/support

For additional information, please contact your local Sales Representative at www.onsemi.com/support/sales