

# MOSFET – N-Channel, POWERTRENCH<sup>®</sup>, SyncFET™

30 V, 22 A, 4.3 mΩ

## FDMS0310AS

### General Description

The FDMS0310AS has been designed to minimize losses in power conversion application. Advancements in both silicon and package technologies have been combined to offer the lowest  $R_{DS(on)}$  while maintaining excellent switching performance. This device has the added benefit of an efficient monolithic Schottky body diode.

### Features

- Max  $R_{DS(on)}$  = 4.3 mΩ at  $V_{GS} = 10\text{ V}$ ,  $I_D = 19\text{ A}$
- Max  $R_{DS(on)}$  = 5.2 mΩ at  $V_{GS} = 4.5\text{ V}$ ,  $I_D = 17\text{ A}$
- Advanced Package and Silicon Combination for Low  $R_{DS(on)}$  and High Efficiency
- SyncFET Schottky Body Diode
- MSL1 Robust Package Design
- 100% UIL Tested
- Pb-Free, Halide Free and RoHS Compliant

### Applications

- Synchronous Rectifier for DC/DC Converters
- Notebook Vcore/GPU Low Side Switch
- Networking Point of Load Low Side Switch
- Telecom Secondary Side Rectification

### MAXIMUM RATINGS ( $T_A = 25^\circ\text{C}$ unless otherwise noted)

Symbol	Parameter	Value	Unit
$V_{DS}$	Drain to Source Voltage	30	V
$V_{GS}$	Gate to Source Voltage (Note 4)	±20	V
$I_D$	Drain Current:		A
	– Continuous (Package limited) $T_C = 25^\circ\text{C}$	22	
	– Continuous (Silicon limited) $T_C = 25^\circ\text{C}$	80	
	– Continuous $T_A = 25^\circ\text{C}$ (Note 1a)	19	
	– Pulsed	100	
$E_{AS}$	Single Pulse Avalanche Energy (Note 3)	33	mJ
$P_D$	Power Dissipation:		W
	$T_C = 25^\circ\text{C}$	41	
	$T_A = 25^\circ\text{C}$ (Note 1a)	2.5	
$T_J, T_{STG}$	Operating and Storage Junction Temperature Range	–55 to +150	$^\circ\text{C}$

Stresses exceeding those listed in the Maximum Ratings table may damage the device. If any of these limits are exceeded, device functionality should not be assumed, damage may occur and reliability may be affected.

$V_{DS}$	$R_{DS(on)}$ MAX	$I_D$ MAX
30 V	4.3 mΩ @ 10 V	22 A
	5.2 mΩ @ 4.5 V	

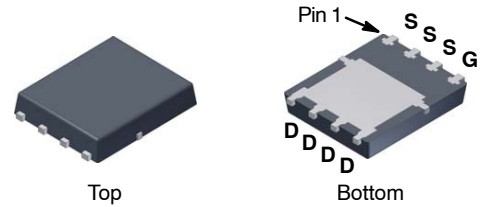

PQFN8 5 × 6, 1.27P  
(Power 56)  
CASE 483AE

### ELECTRICAL CONNECTION

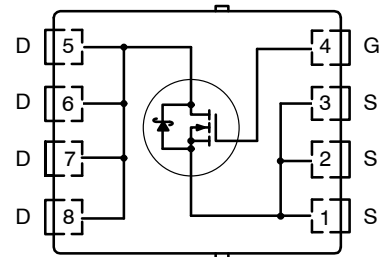

N-CHANNEL MOSFET

### MARKING DIAGRAM

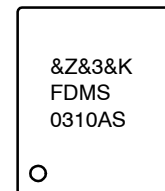

- &Z = Assembly Plant Code
- &3 = 3-Digit Date Code (Year and Week)
- &K = 2-Digit Lot Run Code
- FDMS0310AS = Specific Device Code

### ORDERING INFORMATION

Device	Package	Shipping†
FDMS0310AS	PQFN8 5X6, 1.27P (Pb-Free, Halide Free)	3000 / Tape & Reel

†For information on tape and reel specifications, including part orientation and tape sizes, please refer to our Tape and Reel Packaging Specification Brochure, [BRD8011/D](#).

# FDMS0310AS

## THERMAL CHARACTERISTICS

Symbol	Parameter	Value	Unit
$R_{\theta JC}$	Thermal Resistance, Junction to Case	3.0	°C/W
$R_{\theta JA}$	Thermal Resistance, Junction to Ambient (Note 1a)	50	

## ELECTRICAL CHARACTERISTICS ( $T_J = 25^\circ\text{C}$ unless otherwise noted)

Symbol	Parameter	Test Condition	Min	Typ	Max	Unit
--------	-----------	----------------	-----	-----	-----	------

### OFF CHARACTERISTICS

$BV_{DSS}$	Drain to Source Breakdown Voltage	$I_D = 1\text{ mA}, V_{GS} = 0\text{ V}$	30	–	–	V
$BV_{DSST}$	Drain to Source Breakdown Voltage Transient	$V_{GS} = 0\text{ V}, \text{Transient} = 100\text{ ns}$	33	–	–	V
$\frac{\Delta BV_{DSS}}{\Delta T_J}$	Breakdown Voltage Temperature Coefficient	$I_D = 10\text{ mA}, \text{Referenced to } 25^\circ\text{C}$	–	23	–	mV/°C
$I_{DSS}$	Zero Gate Voltage Drain Current	$V_{DS} = 24\text{ V}, V_{GS} = 0\text{ V}$	–	–	500	μA
$I_{GSS}$	Gate to Source Leakage Current, Forward	$V_{GS} = 20\text{ V}, V_{DS} = 0\text{ V}$	–	–	100	nA

### ON CHARACTERISTICS (Note 2)

$V_{GS(th)}$	Gate to Source Threshold Voltage	$V_{GS} = V_{DS}, I_D = 1\text{ mA}$	1.2	1.5	3.0	V
$\frac{\Delta V_{GS(th)}}{\Delta T_J}$	Gate to Source Threshold Voltage Temperature Coefficient	$I_D = 10\text{ mA}, \text{Referenced to } 25^\circ\text{C}$	–	–4	–	mV/°C
$R_{DS(on)}$	Static Drain to Source On Resistance	$V_{GS} = 10\text{ V}, I_D = 19\text{ A}$	–	3.6	4.3	mΩ
		$V_{GS} = 4.5\text{ V}, I_D = 17\text{ A}$	–	4.5	5.2	
		$V_{GS} = 10\text{ V}, I_D = 19\text{ A}, T_J = 125^\circ\text{C}$	–	4.8	6.0	
$g_{FS}$	Forward Transconductance	$V_{DS} = 5\text{ V}, I_D = 19\text{ A}$	–	103	–	S

### DYNAMIC CHARACTERISTICS

$C_{iss}$	Input Capacitance	$V_{DS} = 15\text{ V}, V_{GS} = 0\text{ V}, f = 1\text{ MHz}$	–	1715	2280	pF
$C_{oss}$	Output Capacitance		–	655	870	pF
$C_{rss}$	Reverse Transfer Capacitance		–	75	110	pF
$R_g$	Gate Resistance		–	0.7	2.5	Ω

### SWITCHING CHARACTERISTICS

$t_{d(on)}$	Turn-On Delay Time	$V_{DD} = 15\text{ V}, I_D = 19\text{ A}, V_{GS} = 10\text{ V}, R_{GEN} = 6\text{ }\Omega$	–	9.0	18	ns
$t_r$	Rise Time		–	3.9	10	ns
$t_{d(off)}$	Turn-Off Delay Time		–	25	40	ns
$t_f$	Fall Time		–	3.2	10	ns
$Q_g$	Total Gate Charge	$V_{GS} = 0\text{ V to } 10\text{ V}, V_{DD} = 15\text{ V}, I_D = 19\text{ A}$	–	27	37	nC
		$V_{GS} = 0\text{ V to } 4.5\text{ V}, V_{DD} = 15\text{ V}, I_D = 19\text{ A}$	–	13	19	nC
$Q_{gs}$	Gate to Source Charge	$V_{DD} = 15\text{ V}, I_D = 19\text{ A}$	–	4.2	–	nC
$Q_{gd}$	Gate to Drain "Miller" Charge	$V_{DD} = 15\text{ V}, I_D = 19\text{ A}$	–	3.7	–	nC

# FDMS0310AS

## ELECTRICAL CHARACTERISTICS ( $T_J = 25^\circ\text{C}$ unless otherwise noted) (continued)

Symbol	Parameter	Test Condition	Min	Typ	Max	Unit
<b>DRAIN-SOURCE DIODE CHARACTERISTICS</b>						
$V_{SD}$	Source to Drain Diode Forward Voltage	$V_{GS} = 0\text{ V}, I_S = 2\text{ A}$ (Note 2)	–	0.6	0.8	V
		$V_{GS} = 0\text{ V}, I_S = 19\text{ A}$ (Note 2)	–	0.8	1.2	
$t_{rr}$	Reverse Recovery Time	$I_F = 19\text{ A}, di/dt = 300\text{ A}/\mu\text{s}$	–	24	38	ns
$Q_{rr}$	Reverse Recovery Charge		–	24	38	nC

Product parametric performance is indicated in the Electrical Characteristics for the listed test conditions, unless otherwise noted. Product performance may not be indicated by the Electrical Characteristics if operated under different conditions.

**NOTES:**

- $R_{\theta JA}$  is determined with the device mounted on a 1 in<sup>2</sup> pad 2 oz copper pad on a 1.5 x 1.5 in. board of FR-4 material.  $R_{\theta JC}$  is guaranteed by design while  $R_{\theta CA}$  is determined by the user's board design.

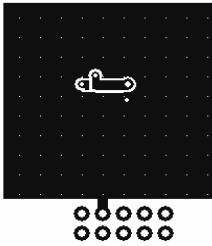

a) 50°C/W when mounted on a 1 in<sup>2</sup> pad of 2 oz copper.

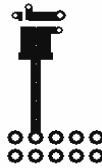

b) 125°C/W when mounted on a minimum pad of 2 oz copper.

- Pulse Test: Pulse Width < 300  $\mu\text{s}$ , Duty cycle < 2.0%.
- $E_{AS}$  of 33 mJ is based on starting  $T_J = 25^\circ\text{C}$ ,  $L = 0.3\text{ mH}$ ,  $I_{AS} = 15\text{ A}$ ,  $V_{DD} = 27\text{ V}$ ,  $V_{GS} = 10\text{ V}$ .
- As an N-ch device, the negative  $V_{GS}$  rating is for low duty cycle pulse occurrence only. No continuous rating is implied.

TYPICAL CHARACTERISTICS

( $T_J = 25^\circ\text{C}$  unless otherwise noted)

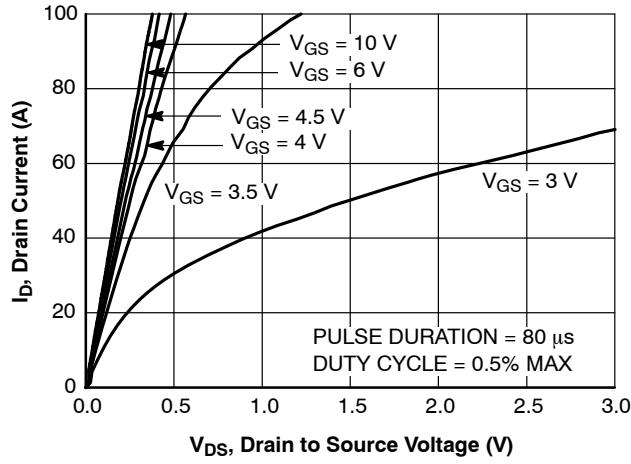

Figure 1. On Region Characteristics

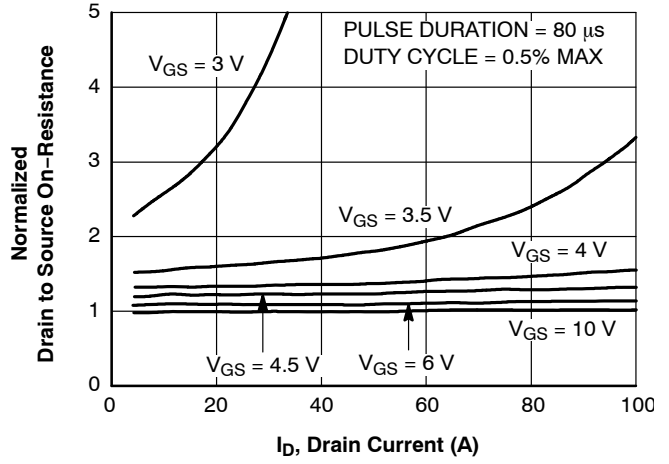

Figure 2. Normalized On-Resistance vs. Drain Current and Gate Voltage

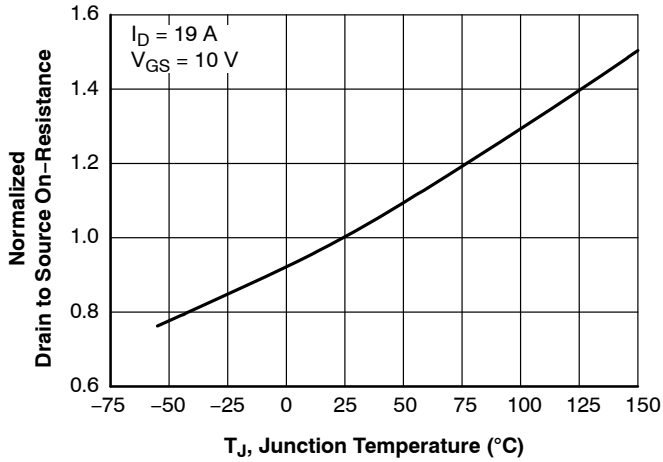

Figure 3. Normalized On-Resistance vs. Junction Temperature

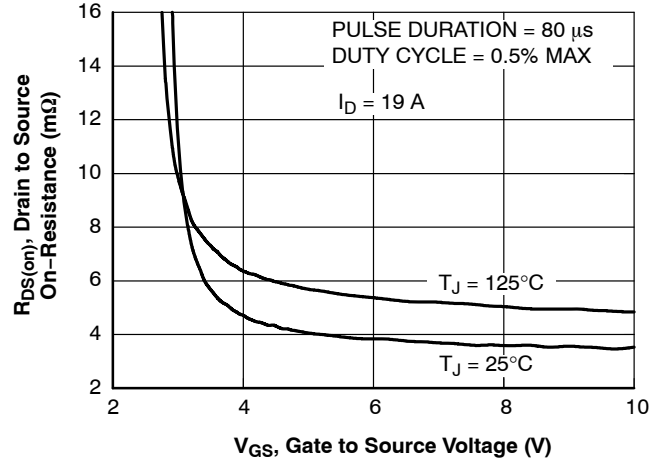

Figure 4. On-Resistance vs. Gate to Source Voltage

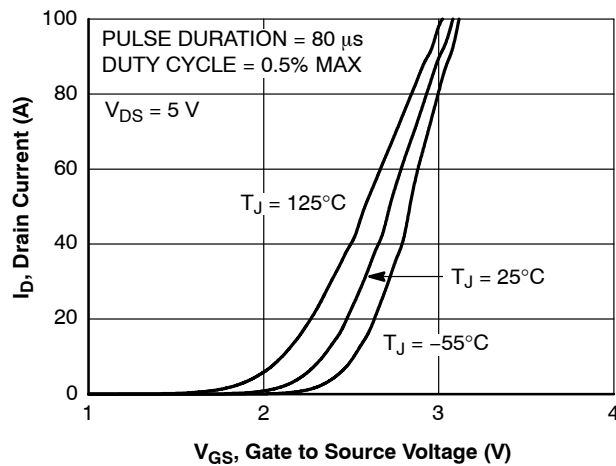

Figure 5. Transfer Characteristics

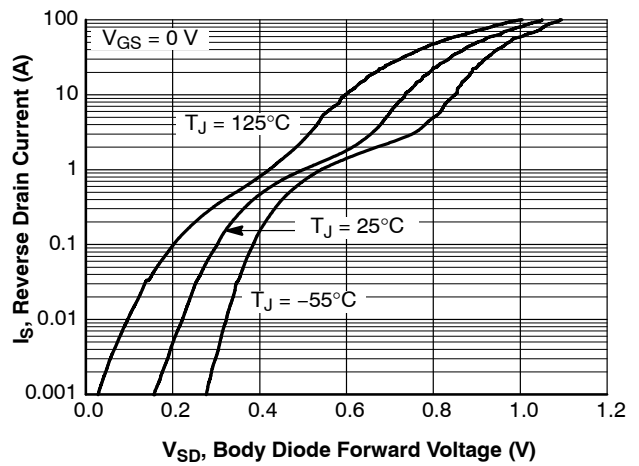

Figure 6. Source to Drain Diode Forward Voltage vs. Source Current

# FDMS0310AS

## TYPICAL CHARACTERISTICS (continued)

( $T_J = 25^\circ\text{C}$  unless otherwise noted)

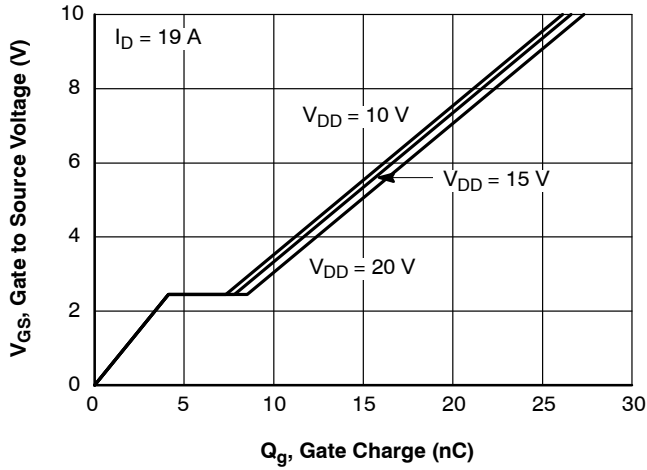

Figure 7. Gate Charge Characteristics

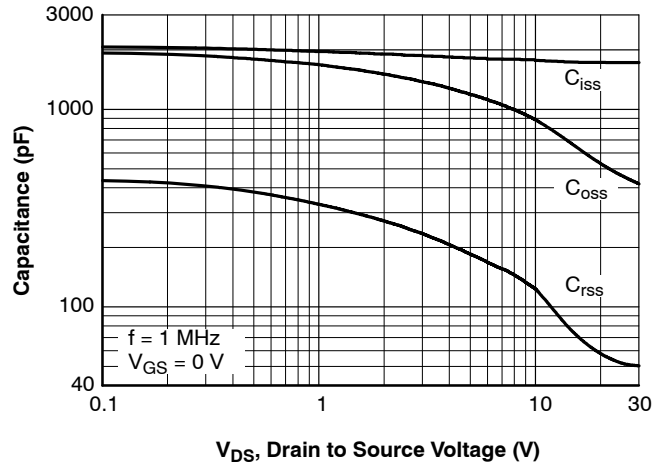

Figure 8. Capacitance vs. Drain to Source Voltage

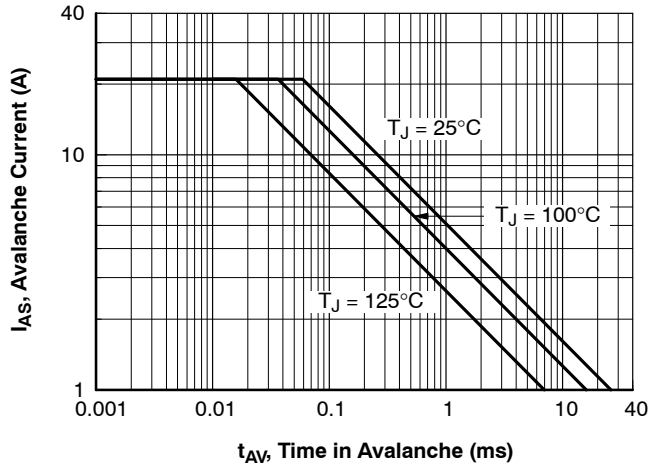

Figure 9. Unclamped Inductive Switching Capability

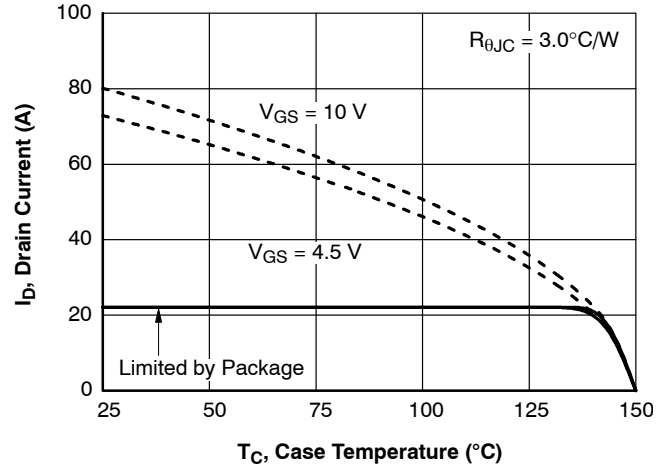

Figure 10. Maximum Continuous Drain Current vs. Case Temperature

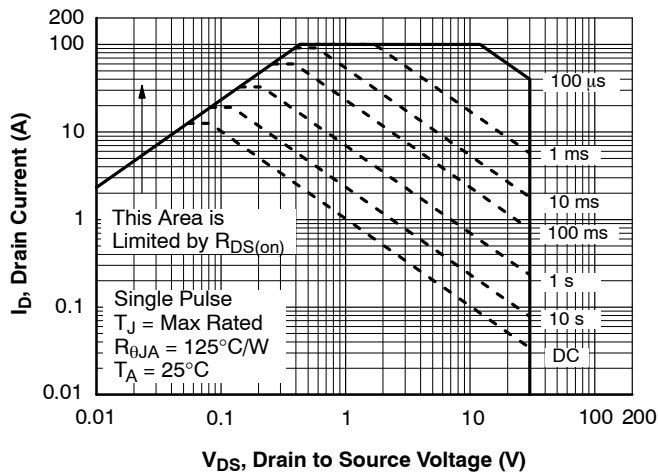

Figure 11. Forward Bias Safe Operating Area

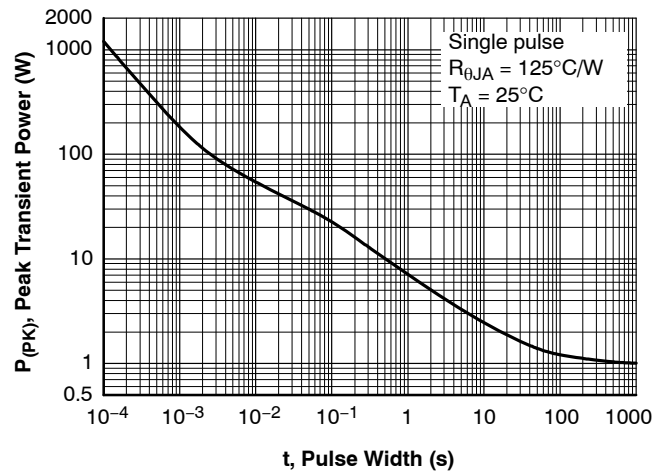

Figure 12. Single Pulse Maximum Power Dissipation

# FDMS0310AS

## TYPICAL CHARACTERISTICS (continued)

( $T_J = 25^\circ\text{C}$  unless otherwise noted)

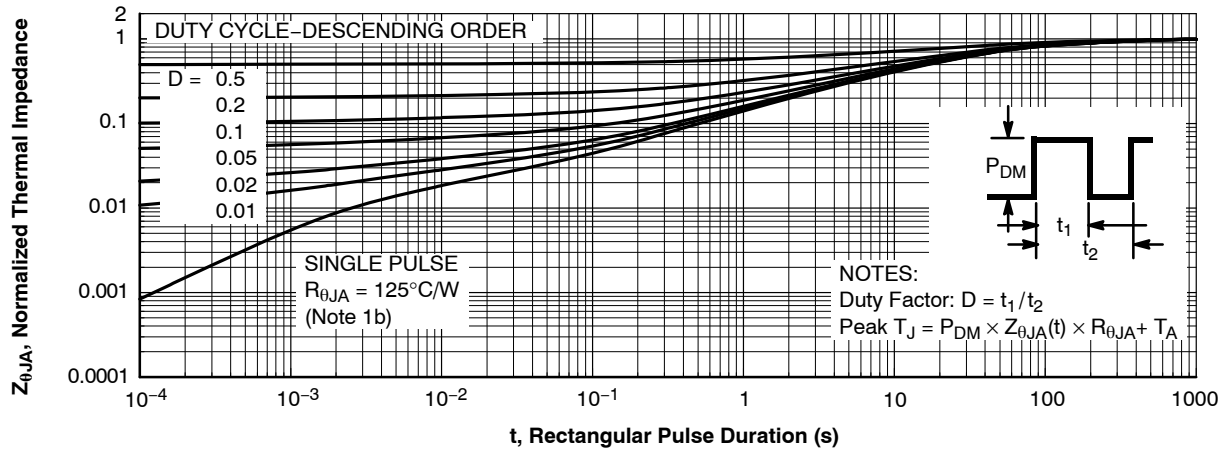

Figure 13. Junction-to-Ambient Transient Thermal Response Curve

# FDMS0310AS

## TYPICAL CHARACTERISTICS (continued)

### SyncFET Schottky Body Diode Characteristics

onsemi's SyncFET process embeds a Schottky diode in parallel with POWERTRENCH MOSFET. This diode exhibits similar characteristics to a discrete external Schottky diode in parallel with a MOSFET. Figure 14 shows the reverse recovery characteristic of the FDMS0310AS.

Schottky barrier diodes exhibit significant leakage at high temperature and high reverse voltage. This will increase the power in the device.

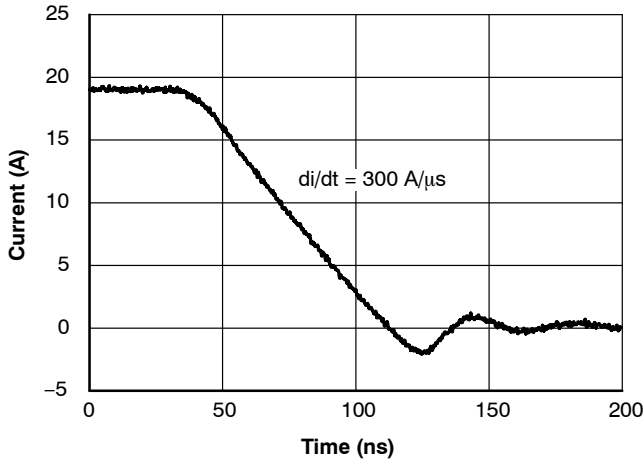

Figure 14. FDMS0310AS SyncFET Body Diode Reverse Recovery Characteristics

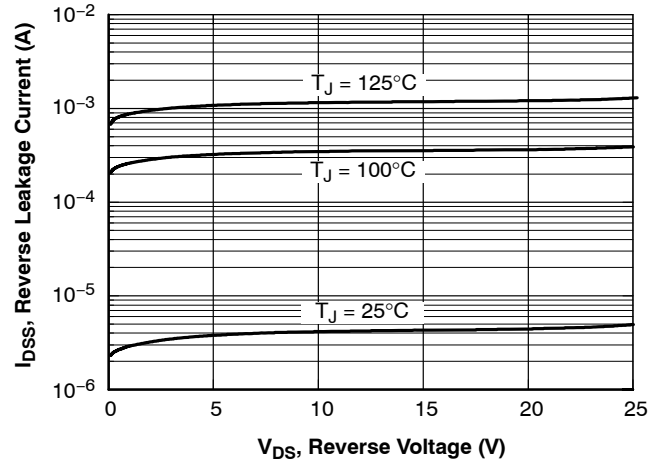
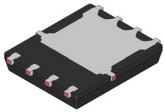

Figure 15. SyncFET Body Diode Reverse Leakage vs. Drain-Source Voltage

POWERTRENCH is a registered trademark of Semiconductor Components Industries, LLC dba "onsemi" or its affiliates and/or subsidiaries in the United States and/or other countries.

SyncFET is a trademark of Semiconductor Components Industries, LLC dba "onsemi" or its affiliates and/or subsidiaries in the United States and/or other countries.

# MECHANICAL CASE OUTLINE PACKAGE DIMENSIONS



**PQFN8 5X6, 1.27P**  
CASE 483AE  
ISSUE C

DATE 21 JAN 2022

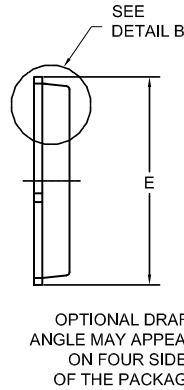
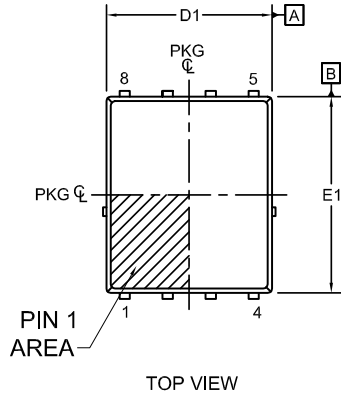

**NOTES:**

1. DIMENSIONING AND TOLERANCING PER ASME Y14.5M, 2009.
2. CONTROLLING DIMENSION: MILLIMETERS
3. COPLANARITY APPLIES TO THE EXPOSED PADS AS WELL AS THE TERMINALS.
4. DIMENSIONS D1 AND E1 DO NOT INCLUDE MOLD FLASH, PROTRUSIONS, OR GATE BURRS.
5. SEATING PLANE IS DEFINED BY THE TERMINALS. "A1" IS DEFINED AS THE DISTANCE FROM THE SEATING PLANE TO THE LOWEST POINT ON THE PACKAGE BODY.
6. IT IS RECOMMENDED TO HAVE NO TRACES OR VIAS WITHIN THE KEEP OUT AREA.

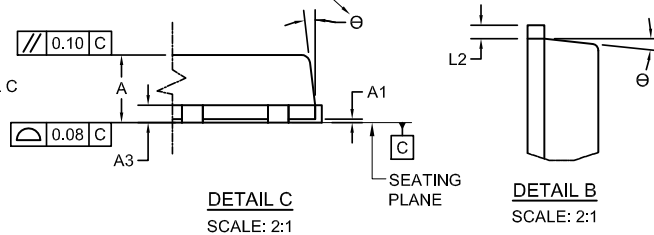
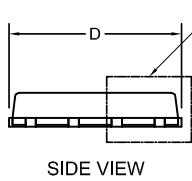

DIM	MILLIMETERS		
	MIN.	NOM.	MAX.
A	0.90	1.00	1.10
A1	0.00	-	0.05
b	0.21	0.31	0.41
b1	0.31	0.41	0.51
A3	0.15	0.25	0.35
D	4.90	5.00	5.20
D1	4.80	4.90	5.00
D2	3.61	3.82	3.96
E	5.90	6.15	6.25
E1	5.70	5.80	5.90
E2	3.38	3.48	3.78
E3	0.30 REF		
E4	0.52 REF		
e	1.27 BSC		
e/2	0.635 BSC		
e1	3.81 BSC		
e2	0.50 REF		
L	0.51	0.66	0.76
L2	0.05	0.18	0.30
L4	0.34	0.44	0.54
z	0.34 REF		
θ	0°	-	12°

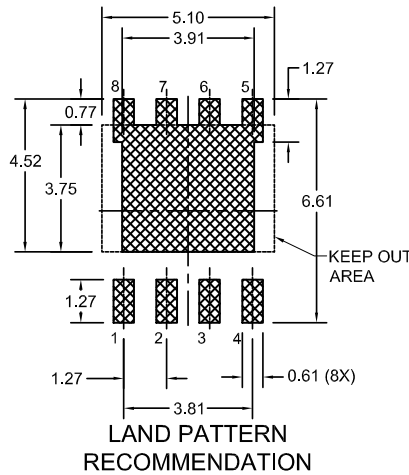
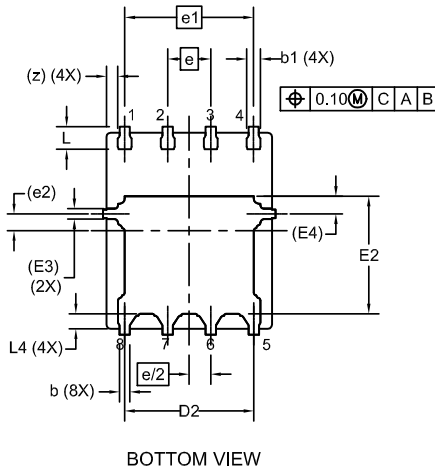

\*FOR ADDITIONAL INFORMATION ON OUR PB-FREE STRATEGY AND SOLDERING DETAILS, PLEASE DOWNLOAD THE ON SEMICONDUCTOR SOLDERING AND MOUNTING TECHNIQUES REFERENCE MANUAL, SOLDERRM/D.

<b>DOCUMENT NUMBER:</b>	<b>98AON13655G</b>	Electronic versions are uncontrolled except when accessed directly from the Document Repository. Printed versions are uncontrolled except when stamped "CONTROLLED COPY" in red.
<b>DESCRIPTION:</b>	<b>PQFN8 5X6, 1.27P</b>	<b>PAGE 1 OF 1</b>

onsemi and ONSEMI are trademarks of Semiconductor Components Industries, LLC dba onsemi or its subsidiaries in the United States and/or other countries. onsemi reserves the right to make changes without further notice to any products herein. onsemi makes no warranty, representation or guarantee regarding the suitability of its products for any particular purpose, nor does onsemi assume any liability arising out of the application or use of any product or circuit, and specifically disclaims any and all liability, including without limitation special, consequential or incidental damages. onsemi does not convey any license under its patent rights nor the rights of others.



**onsemi**, **Onsemi**, and other names, marks, and brands are registered and/or common law trademarks of Semiconductor Components Industries, LLC dba "**onsemi**" or its affiliates and/or subsidiaries in the United States and/or other countries. **onsemi** owns the rights to a number of patents, trademarks, copyrights, trade secrets, and other intellectual property. A listing of **onsemi**'s product/patent coverage may be accessed at [www.onsemi.com/site/pdf/Patent-Marking.pdf](http://www.onsemi.com/site/pdf/Patent-Marking.pdf). **onsemi** reserves the right to make changes at any time to any products or information herein, without notice. The information herein is provided "as-is" and **onsemi** makes no warranty, representation or guarantee regarding the accuracy of the information, product features, availability, functionality, or suitability of its products for any particular purpose, nor does **onsemi** assume any liability arising out of the application or use of any product or circuit, and specifically disclaims any and all liability, including without limitation special, consequential or incidental damages. Buyer is responsible for its products and applications using **onsemi** products, including compliance with all laws, regulations and safety requirements or standards, regardless of any support or applications information provided by **onsemi**. "Typical" parameters which may be provided in **onsemi** data sheets and/or specifications can and do vary in different applications and actual performance may vary over time. All operating parameters, including "Typicals" must be validated for each customer application by customer's technical experts. **onsemi** does not convey any license under any of its intellectual property rights nor the rights of others. **onsemi** products are not designed, intended, or authorized for use as a critical component in life support systems or any FDA Class 3 medical devices or medical devices with a same or similar classification in a foreign jurisdiction or any devices intended for implantation in the human body. Should Buyer purchase or use **onsemi** products for any such unintended or unauthorized application, Buyer shall indemnify and hold **onsemi** and its officers, employees, subsidiaries, affiliates, and distributors harmless against all claims, costs, damages, and expenses, and reasonable attorney fees arising out of, directly or indirectly, any claim of personal injury or death associated with such unintended or unauthorized use, even if such claim alleges that **onsemi** was negligent regarding the design or manufacture of the part. **onsemi** is an Equal Opportunity/Affirmative Action Employer. This literature is subject to all applicable copyright laws and is not for resale in any manner.

## ADDITIONAL INFORMATION

### TECHNICAL PUBLICATIONS:

Technical Library: [www.onsemi.com/design/resources/technical-documentation](http://www.onsemi.com/design/resources/technical-documentation)  
onsemi Website: [www.onsemi.com](http://www.onsemi.com)

### ONLINE SUPPORT: [www.onsemi.com/support](http://www.onsemi.com/support)

For additional information, please contact your local Sales Representative at [www.onsemi.com/support/sales](http://www.onsemi.com/support/sales)