



January 2015

# FDMS86150ET100

## N-Channel Shielded Gate PowerTrench<sup>®</sup> MOSFET

100 V, 128 A, 4.85 mΩ

### Features

- Extended T<sub>J</sub> rating to 175°C
- Shielded Gate MOSFET Technology
- Max r<sub>DS(on)</sub> = 4.85 mΩ at V<sub>GS</sub> = 10 V, I<sub>D</sub> = 16 A
- Max r<sub>DS(on)</sub> = 7.8 mΩ at V<sub>GS</sub> = 6 V, I<sub>D</sub> = 13 A
- Advanced Package and Silicon combination for low r<sub>DS(on)</sub> and high efficiency
- MSL1 robust package design
- 100% UIL tested
- RoHS Compliant

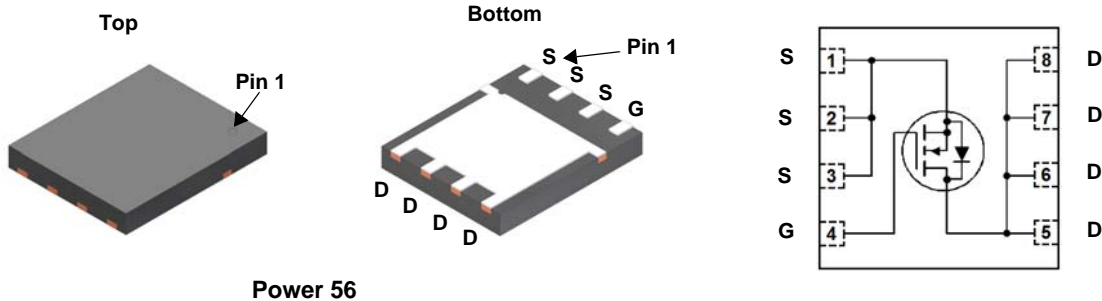


### General Description

This N-Channel MOSFET is produced using Fairchild Semiconductor's advanced PowerTrench<sup>®</sup> process that incorporates Shielded Gate technology. This process has been optimized for the on-state resistance and yet maintain superior switching performance.

### Applications

- Primary DC-DC MOSFET
- Secondary Synchronous Rectifier
- Load Switch



Power 56

### MOSFET Maximum Ratings T<sub>A</sub> = 25 °C unless otherwise noted

Symbol	Parameter	Rated	Units
V <sub>DS</sub>	Drain to Source Voltage	100	V
V <sub>GS</sub>	Gate to Source Voltage	±20	V
I <sub>D</sub>	Drain Current -Continuous	T <sub>C</sub> = 25 °C (Note 5)	128
	-Continuous	T <sub>C</sub> = 100 °C (Note 5)	90
	-Continuous	T <sub>A</sub> = 25 °C (Note 1a)	16
	-Pulsed	(Note 4)	617
E <sub>AS</sub>	Single Pulse Avalanche Energy	(Note 3)	726
P <sub>D</sub>	Power Dissipation	T <sub>C</sub> = 25 °C	187
	Power Dissipation	T <sub>A</sub> = 25 °C (Note 1a)	3.3
T <sub>J</sub> , T <sub>STG</sub>	Operating and Storage Junction Temperature Range	-55 to +175	°C

### Thermal Characteristics

R <sub>θJC</sub>	Thermal Resistance, Junction to Case	0.8	°C/W
R <sub>θJA</sub>	Thermal Resistance, Junction to Ambient (Note 1a)	45	

### Package Marking and Ordering Information

Device Marking	Device	Package	Reel Size	Tape Width	Quantity
FDMS86150ET	FDMS86150ET100	Power 56	13 "	12 mm	3000 units

FDMS86150ET100 N-Channel Shielded Gate PowerTrench<sup>®</sup> MOSFET

## Electrical Characteristics $T_J = 25\text{ }^\circ\text{C}$ unless otherwise noted

Symbol	Parameter	Test Conditions	Min	Typ	Max	Units
--------	-----------	-----------------	-----	-----	-----	-------

### Off Characteristics

$BV_{DSS}$	Drain to Source Breakdown Voltage	$I_D = 250\text{ }\mu\text{A}$ , $V_{GS} = 0\text{ V}$	100			V
$\frac{\Delta BV_{DSS}}{\Delta T_J}$	Breakdown Voltage Temperature Coefficient	$I_D = 250\text{ }\mu\text{A}$ , referenced to $25\text{ }^\circ\text{C}$		72		mV/ $^\circ\text{C}$
$I_{DSS}$	Zero Gate Voltage Drain Current	$V_{DS} = 80\text{ V}$ , $V_{GS} = 0\text{ V}$			1	$\mu\text{A}$
$I_{GSS}$	Gate to Source Leakage Current	$V_{GS} = \pm 20\text{ V}$ , $V_{DS} = 0\text{ V}$			$\pm 100$	nA

### On Characteristics

$V_{GS(th)}$	Gate to Source Threshold Voltage	$V_{GS} = V_{DS}$ , $I_D = 250\text{ }\mu\text{A}$	2	3	4	V
$\frac{\Delta V_{GS(th)}}{\Delta T_J}$	Gate to Source Threshold Voltage Temperature Coefficient	$I_D = 250\text{ }\mu\text{A}$ , referenced to $25\text{ }^\circ\text{C}$		-10		mV/ $^\circ\text{C}$
$r_{DS(on)}$	Static Drain to Source On Resistance	$V_{GS} = 10\text{ V}$ , $I_D = 16\text{ A}$		3.9	4.85	m $\Omega$
		$V_{GS} = 6\text{ V}$ , $I_D = 13\text{ A}$		6	7.8	
		$V_{GS} = 10\text{ V}$ , $I_D = 16\text{ A}$ , $T_J = 125\text{ }^\circ\text{C}$		7.3	9.1	
$g_{FS}$	Forward Transconductance	$V_{DS} = 10\text{ V}$ , $I_D = 16\text{ A}$		53		S

### Dynamic Characteristics

$C_{iss}$	Input Capacitance	$V_{DS} = 50\text{ V}$ , $V_{GS} = 0\text{ V}$ , $f = 1\text{ MHz}$		3055	4065	pF
$C_{oss}$	Output Capacitance			696	930	pF
$C_{rss}$	Reverse Transfer Capacitance			29	50	pF
$R_g$	Gate Resistance		0.1	0.7	3.6	$\Omega$

### Switching Characteristics

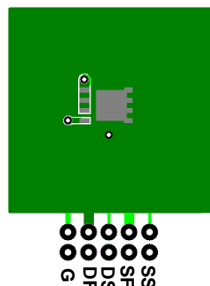
$t_{d(on)}$	Turn-On Delay Time	$V_{DD} = 50\text{ V}$ , $I_D = 16\text{ A}$ , $V_{GS} = 10\text{ V}$ , $R_{GEN} = 6\text{ }\Omega$		18	33	ns	
$t_r$	Rise Time			8.3	17	ns	
$t_{d(off)}$	Turn-Off Delay Time			28	45	ns	
$t_f$	Fall Time			6	12	ns	
$Q_g$	Total Gate Charge		$V_{GS} = 0\text{ V to }10\text{ V}$		44	62	nC
$Q_g$	Total Gate Charge	$V_{GS} = 0\text{ V to }5\text{ V}$	$V_{DD} = 50\text{ V}$ , $I_D = 16\text{ A}$		25	35	nC
$Q_{gs}$	Gate to Source Charge				12.9		nC
$Q_{gd}$	Gate to Drain "Miller" Charge				9.2		nC

### Drain-Source Diode Characteristics

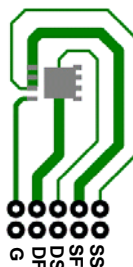
$V_{SD}$	Source to Drain Diode Forward Voltage	$V_{GS} = 0\text{ V}$ , $I_S = 2.1\text{ A}$ (Note 2)		0.69	1.2	V
		$V_{GS} = 0\text{ V}$ , $I_S = 16\text{ A}$ (Note 2)		0.78	1.3	
$t_{rr}$	Reverse Recovery Time	$I_F = 16\text{ A}$ , $di/dt = 100\text{ A}/\mu\text{s}$		69	110	ns
$Q_{rr}$	Reverse Recovery Charge			94	150	nC

#### Notes:

1.  $R_{\theta JA}$  is determined with the device mounted on a  $1\text{ in}^2$  pad 2 oz copper pad on a  $1.5 \times 1.5\text{ in.}$  board of FR-4 material.  $R_{\theta CA}$  is determined by the user's board design.



a.  $45\text{ }^\circ\text{C/W}$  when mounted on a  $1\text{ in}^2$  pad of 2 oz copper.



b.  $115\text{ }^\circ\text{C/W}$  when mounted on a minimum pad of 2 oz copper.

2. Pulse Test: Pulse Width  $< 300\text{ }\mu\text{s}$ , Duty cycle  $< 2.0\%$ .

3.  $E_{AS}$  of 726 mJ is based on starting  $T_J = 25\text{ }^\circ\text{C}$ ,  $L = 3\text{ mH}$ ,  $I_{AS} = 22\text{ A}$ ,  $V_{DD} = 100\text{ V}$ ,  $V_{GS} = 10\text{ V}$ , 100% test at  $L = 0.1\text{ mH}$ ,  $I_{AS} = 69\text{ A}$ .

4. Pulse Id please refer to Fig.11 SOA curve for detail.

5. Computed continuous current limited to Max Junction Temperature only, actual continuous current will be limited by thermal & electro-mechanical application board design.

**Typical Characteristics**  $T_J = 25\text{ }^\circ\text{C}$  unless otherwise noted

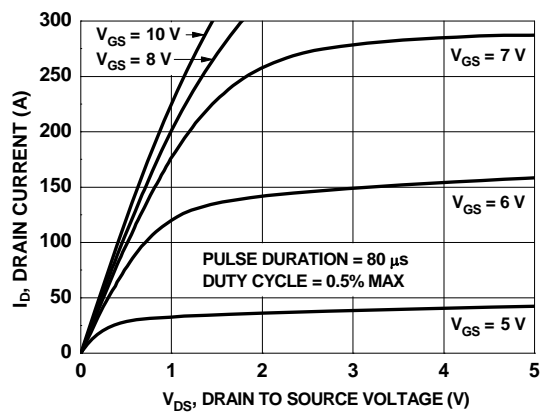


Figure 1. On Region Characteristics

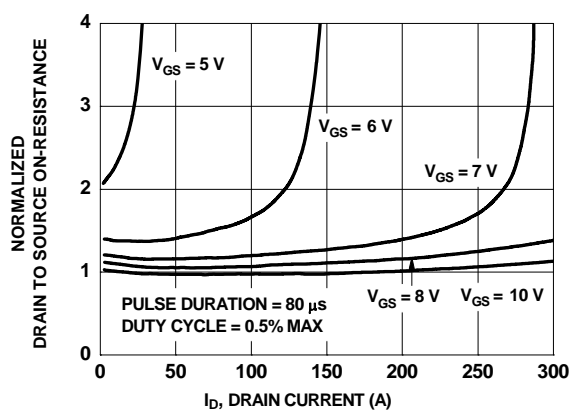


Figure 2. Normalized On-Resistance vs Drain Current and Gate Voltage

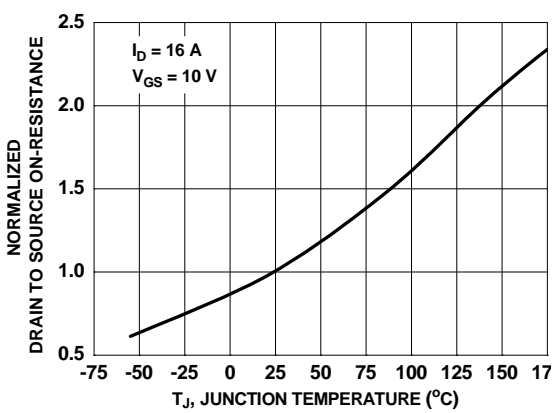


Figure 3. Normalized On Resistance vs Junction Temperature

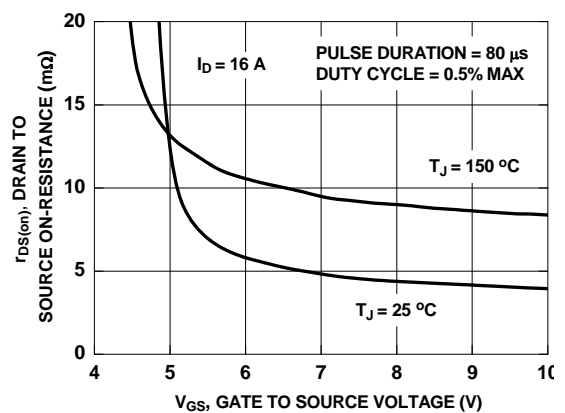


Figure 4. On-Resistance vs Gate to Source Voltage

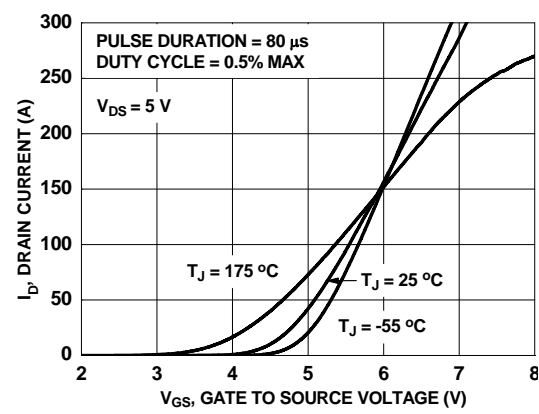


Figure 5. Transfer Characteristics

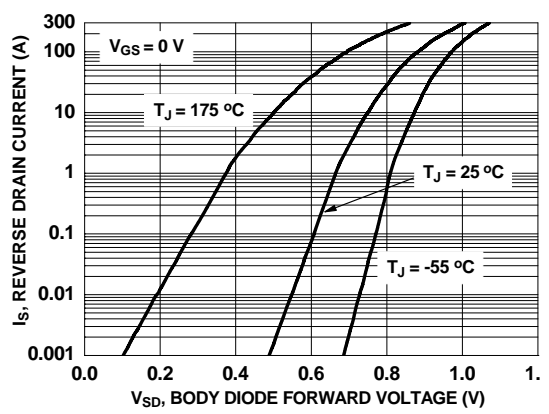
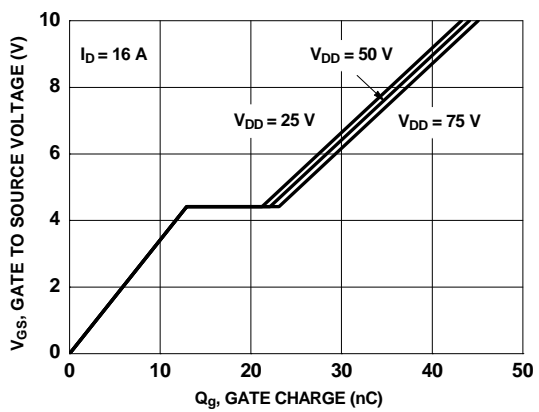
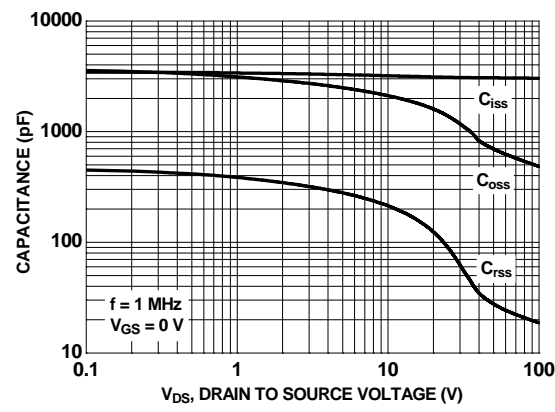


Figure 6. Source to Drain Diode Forward Voltage vs Source Current

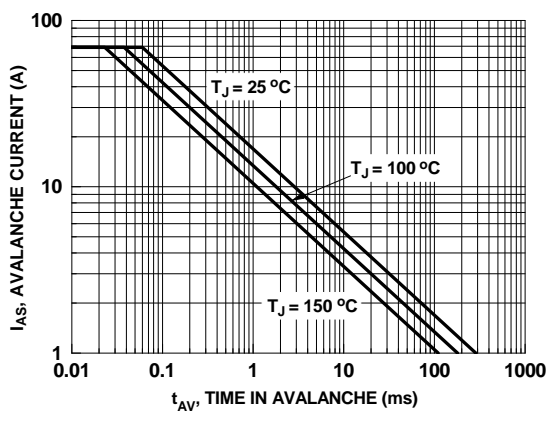
**Typical Characteristics**  $T_J = 25\text{ }^\circ\text{C}$  unless otherwise noted



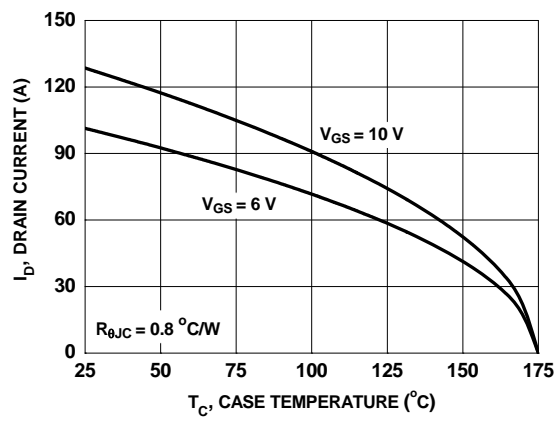
**Figure 7. Gate Charge Characteristics**



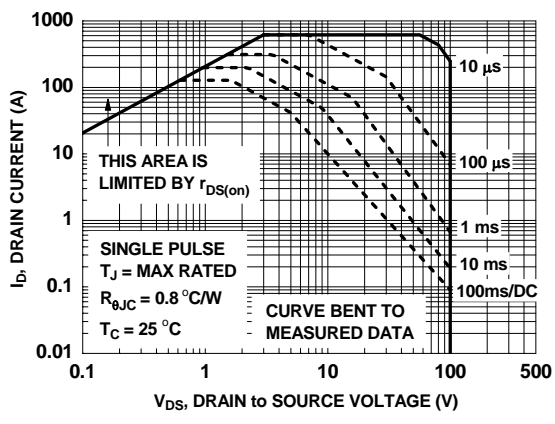
**Figure 8. Capacitance vs Drain to Source Voltage**



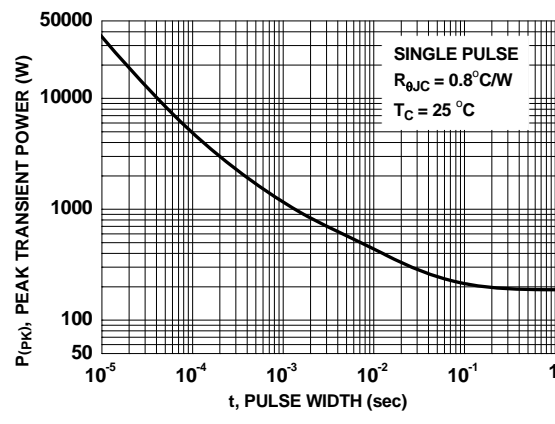
**Figure 9. Unclamped Inductive Switching Capability**



**Figure 10. Maximum Continuous Drain Current vs Case Temperature**

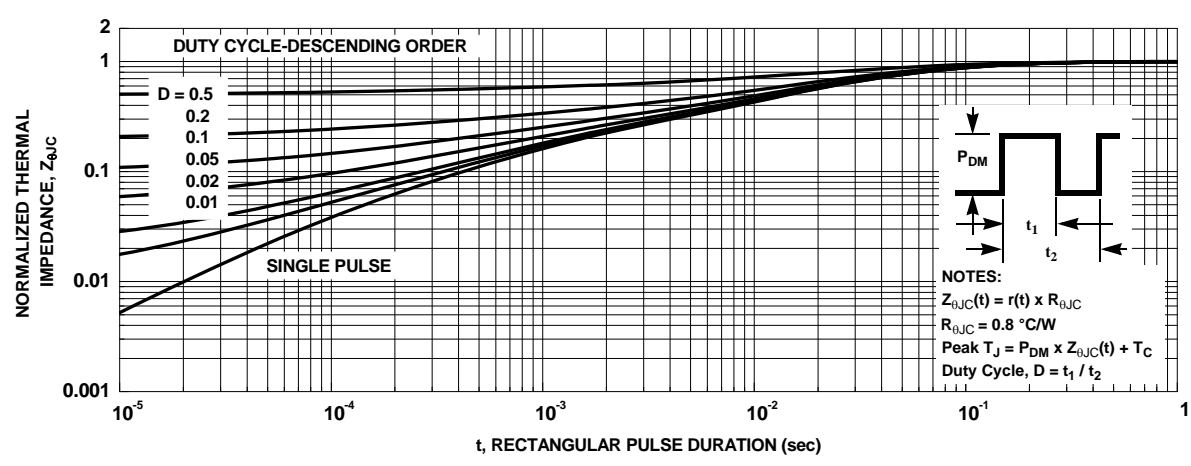


**Figure 11. Forward Bias Safe Operating Area**

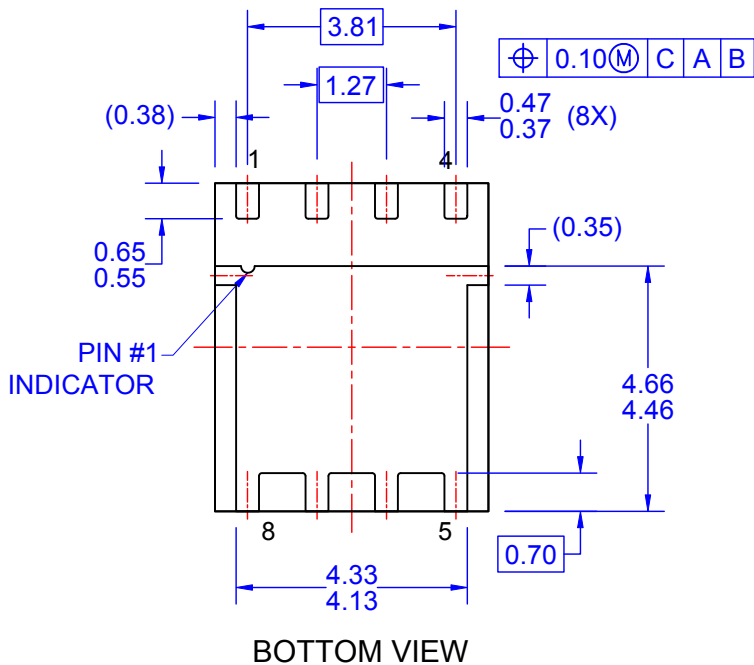
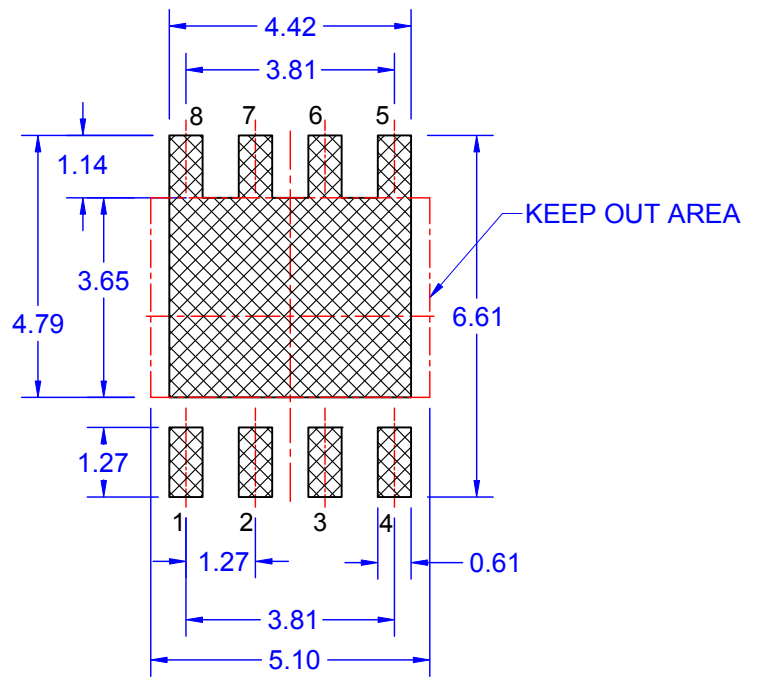
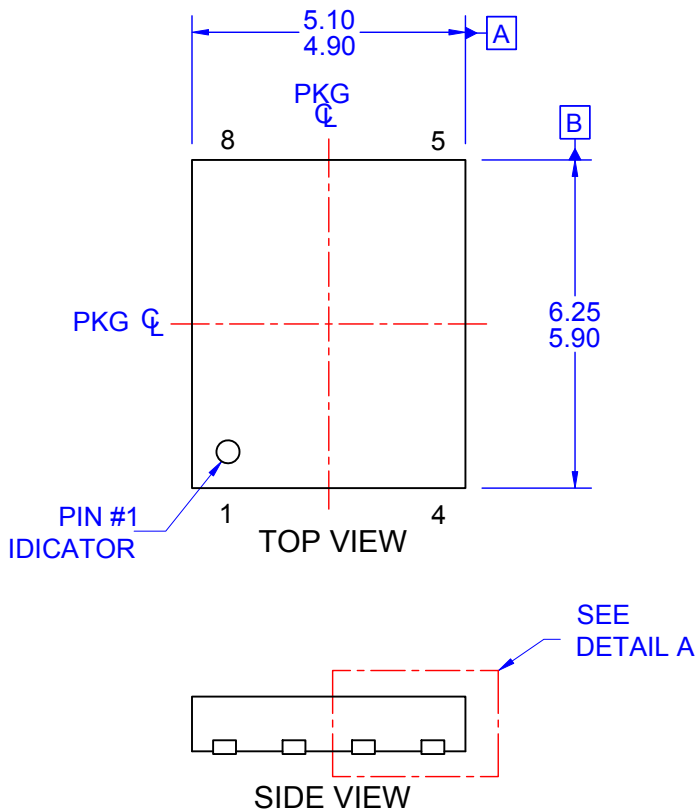


**Figure 12. Single Pulse Maximum Power Dissipation**

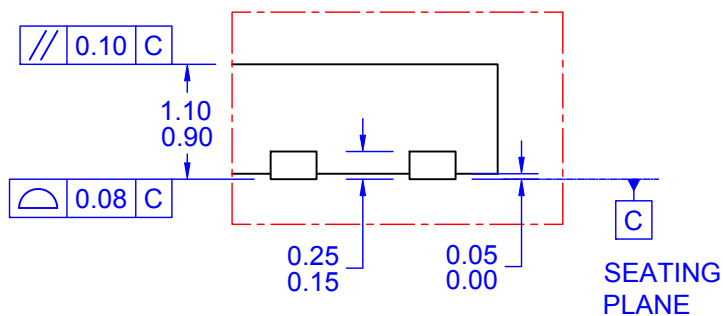
**Typical Characteristics**  $T_J = 25\text{ }^\circ\text{C}$  unless otherwise noted



**Figure 13. Junction-to-Ambient Transient Thermal Response Curve**



- NOTES: UNLESS OTHERWISE SPECIFIED
- A) PACKAGE STANDARD REFERENCE: JEDEC MO-240, ISSUE A, VAR. AA,
  - B) ALL DIMENSIONS ARE IN MILLIMETERS.
  - C) DIMENSIONS DO NOT INCLUDE BURRS OR MOLD FLASH. MOLD FLASH OR BURRS DOES NOT EXCEED 0.10MM.
  - D) DIMENSIONING AND TOLERANCING PER ASME Y14.5M-2009.
  - E) IT IS RECOMMENDED TO HAVE NO TRACES OR VIAS WITHIN THE KEEP OUT AREA.
  - F) DRAWING FILE NAME: PQFN08JREV3.



**DETAIL A**  
SCALE: 2:1



ON Semiconductor and  are trademarks of Semiconductor Components Industries, LLC dba ON Semiconductor or its subsidiaries in the United States and/or other countries. ON Semiconductor owns the rights to a number of patents, trademarks, copyrights, trade secrets, and other intellectual property. A listing of ON Semiconductor's product/patent coverage may be accessed at [www.onsemi.com/site/pdf/Patent-Marking.pdf](http://www.onsemi.com/site/pdf/Patent-Marking.pdf). ON Semiconductor reserves the right to make changes without further notice to any products herein. ON Semiconductor makes no warranty, representation or guarantee regarding the suitability of its products for any particular purpose, nor does ON Semiconductor assume any liability arising out of the application or use of any product or circuit, and specifically disclaims any and all liability, including without limitation special, consequential or incidental damages. Buyer is responsible for its products and applications using ON Semiconductor products, including compliance with all laws, regulations and safety requirements or standards, regardless of any support or applications information provided by ON Semiconductor. "Typical" parameters which may be provided in ON Semiconductor data sheets and/or specifications can and do vary in different applications and actual performance may vary over time. All operating parameters, including "Typicals" must be validated for each customer application by customer's technical experts. ON Semiconductor does not convey any license under its patent rights nor the rights of others. ON Semiconductor products are not designed, intended, or authorized for use as a critical component in life support systems or any FDA Class 3 medical devices or medical devices with a same or similar classification in a foreign jurisdiction or any devices intended for implantation in the human body. Should Buyer purchase or use ON Semiconductor products for any such unintended or unauthorized application, Buyer shall indemnify and hold ON Semiconductor and its officers, employees, subsidiaries, affiliates, and distributors harmless against all claims, costs, damages, and expenses, and reasonable attorney fees arising out of, directly or indirectly, any claim of personal injury or death associated with such unintended or unauthorized use, even if such claim alleges that ON Semiconductor was negligent regarding the design or manufacture of the part. ON Semiconductor is an Equal Opportunity/Affirmative Action Employer. This literature is subject to all applicable copyright laws and is not for resale in any manner.

## PUBLICATION ORDERING INFORMATION

### LITERATURE FULFILLMENT:

Literature Distribution Center for ON Semiconductor  
19521 E. 32nd Pkwy, Aurora, Colorado 80011 USA  
**Phone:** 303-675-2175 or 800-344-3860 Toll Free USA/Canada  
**Fax:** 303-675-2176 or 800-344-3867 Toll Free USA/Canada  
**Email:** [orderlit@onsemi.com](mailto:orderlit@onsemi.com)

**N. American Technical Support:** 800-282-9855 Toll Free  
USA/Canada  
**Europe, Middle East and Africa Technical Support:**  
Phone: 421 33 790 2910  
**Japan Customer Focus Center**  
Phone: 81-3-5817-1050

**ON Semiconductor Website:** [www.onsemi.com](http://www.onsemi.com)  
**Order Literature:** <http://www.onsemi.com/orderlit>  
For additional information, please contact your local  
Sales Representative