



# FDMT800152DC

## N-Channel Dual Cool™ 88 PowerTrench® MOSFET

150 V, 72 A, 9.0 mΩ

### Features

- Max  $r_{DS(on)}$  = 9.0 mΩ at  $V_{GS} = 10\text{ V}$ ,  $I_D = 13\text{ A}$
- Max  $r_{DS(on)}$  = 11.5 mΩ at  $V_{GS} = 6\text{ V}$ ,  $I_D = 11\text{ A}$
- Advanced Package and Silicon combination for low  $r_{DS(on)}$  and high efficiency
- Next generation enhanced body diode technology, engineered for soft recovery
- Low profile 8x8mm MLP package
- MSL1 robust package design
- 100% UIL tested
- RoHS Compliant

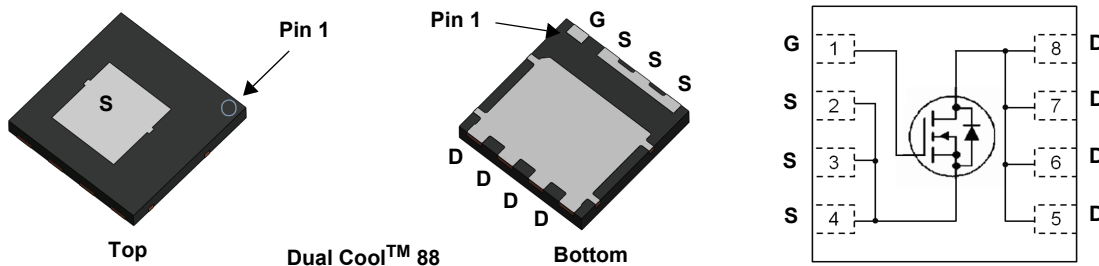


### General Description

This N-Channel MOSFET is produced using Fairchild Semiconductor's advanced PowerTrench® process. Advancements in both silicon and Dual Cool™ package technologies have been combined to offer the lowest  $r_{DS(on)}$  while maintaining excellent switching performance by extremely low Junction-to-Ambient thermal resistance.

### Applications

- OringFET / Load Switching
- Synchronous Rectification
- DC-DC Conversion



### MOSFET Maximum Ratings $T_A = 25\text{ °C}$ unless otherwise noted.

Symbol	Parameter	Ratings	Units
$V_{DS}$	Drain to Source Voltage	150	V
$V_{GS}$	Gate to Source Voltage	±20	V
$I_D$	Drain Current -Continuous	$T_C = 25\text{ °C}$ (Note 5)	72
	-Continuous	$T_C = 100\text{ °C}$ (Note 5)	45
	-Continuous	$T_A = 25\text{ °C}$ (Note 1a)	13
	-Pulsed	(Note 4)	413
$E_{AS}$	Single Pulse Avalanche Energy	(Note 3)	726
$P_D$	Power Dissipation	$T_C = 25\text{ °C}$	113
	Power Dissipation	$T_A = 25\text{ °C}$ (Note 1a)	3.2
$T_J, T_{STG}$	Operating and Storage Junction Temperature Range	-55 to +150	°C

### Thermal Characteristics

$R_{\theta JC}$	Thermal Resistance, Junction-to-Case	(Top Source)	2.0	°C/W
$R_{\theta JC}$	Thermal Resistance, Junction-to-Case	(Bottom Drain)	1.1	
$R_{\theta JA}$	Thermal Resistance, Junction-to-Ambient	(Note 1a)	38	
$R_{\theta JA}$	Thermal Resistance, Junction-to-Ambient	(Note 1b)	81	
$R_{\theta JA}$	Thermal Resistance, Junction-to-Ambient	(Note 1i)	15	
$R_{\theta JA}$	Thermal Resistance, Junction-to-Ambient	(Note 1j)	21	
$R_{\theta JA}$	Thermal Resistance, Junction-to-Ambient	(Note 1k)	9	

### Package Marking and Ordering Information

Device Marking	Device	Package	Reel Size	Tape Width	Quantity
800152DC	FDMT800152DC	Dual Cool™ 88	13"	13.3 mm	3000 units

**Electrical Characteristics**  $T_J = 25\text{ }^\circ\text{C}$  unless otherwise noted.

Symbol	Parameter	Test Conditions	Min.	Typ.	Max.	Units
--------	-----------	-----------------	------	------	------	-------

**Off Characteristics**

$BV_{DSS}$	Drain to Source Breakdown Voltage	$I_D = 250\text{ }\mu\text{A}$ , $V_{GS} = 0\text{ V}$	150			V
$\frac{\Delta BV_{DSS}}{\Delta T_J}$	Breakdown Voltage Temperature Coefficient	$I_D = 250\text{ }\mu\text{A}$ , referenced to $25\text{ }^\circ\text{C}$		114		mV/°C
$I_{DSS}$	Zero Gate Voltage Drain Current	$V_{DS} = 120\text{ V}$ , $V_{GS} = 0\text{ V}$			1	$\mu\text{A}$
$I_{GSS}$	Gate to Source Leakage Current	$V_{GS} = \pm 20\text{ V}$ , $V_{DS} = 0\text{ V}$			100	nA

**On Characteristics**

$V_{GS(th)}$	Gate to Source Threshold Voltage	$V_{GS} = V_{DS}$ , $I_D = 250\text{ }\mu\text{A}$	2.0	2.9	4.0	V
$\frac{\Delta V_{GS(th)}}{\Delta T_J}$	Gate to Source Threshold Voltage Temperature Coefficient	$I_D = 250\text{ }\mu\text{A}$ , referenced to $25\text{ }^\circ\text{C}$		-11		mV/°C
$r_{DS(on)}$	Static Drain to Source On Resistance	$V_{GS} = 10\text{ V}$ , $I_D = 13\text{ A}$		6.9	9.0	m $\Omega$
		$V_{GS} = 6\text{ V}$ , $I_D = 11\text{ A}$		8.6	11.5	
		$V_{GS} = 10\text{ V}$ , $I_D = 13\text{ A}$ , $T_J = 125\text{ }^\circ\text{C}$		14.6	19	
$g_{FS}$	Forward Transconductance	$V_{DS} = 5\text{ V}$ , $I_D = 13\text{ A}$		41		S

**Dynamic Characteristics**

$C_{iss}$	Input Capacitance	$V_{DS} = 75\text{ V}$ , $V_{GS} = 0\text{ V}$ , $f = 1\text{ MHz}$		4196	5875	pF
$C_{oss}$	Output Capacitance			379	530	pF
$C_{rss}$	Reverse Transfer Capacitance			16	30	pF
$R_g$	Gate Resistance		0.1	1.3	3.3	$\Omega$

**Switching Characteristics**

$t_{d(on)}$	Turn-On Delay Time	$V_{DD} = 75\text{ V}$ , $I_D = 13\text{ A}$ , $V_{GS} = 10\text{ V}$ , $R_{GEN} = 6\text{ }\Omega$		24	39	ns
$t_r$	Rise Time			13	23	ns
$t_{d(off)}$	Turn-Off Delay Time			36	58	ns
$t_f$	Fall Time			7.9	16	ns
$Q_{g(TOT)}$	Total Gate Charge	$V_{GS} = 0\text{ V to }10\text{ V}$	$V_{DD} = 75\text{ V}$ , $I_D = 13\text{ A}$	59	83	nC
$Q_{g(TOT)}$	Total Gate Charge	$V_{GS} = 0\text{ V to }6\text{ V}$		38	53	nC
$Q_{gs}$	Gate to Source Charge			18		nC
$Q_{gd}$	Gate to Drain "Miller" Charge			12		nC

**Drain-Source Diode Characteristics**

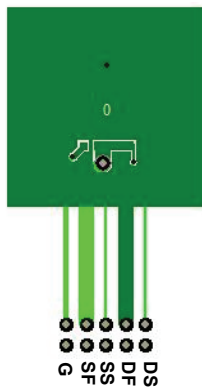
$V_{SD}$	Source to Drain Diode Forward Voltage	$V_{GS} = 0\text{ V}$ , $I_S = 2.9\text{ A}$ (Note 2)		0.7	1.1	V
		$V_{GS} = 0\text{ V}$ , $I_S = 13\text{ A}$ (Note 2)		0.8	1.2	
$t_{rr}$	Reverse Recovery Time	$I_F = 13\text{ A}$ , $di/dt = 100\text{ A}/\mu\text{s}$		95	152	ns
$Q_{rr}$	Reverse Recovery Charge			187	299	nC

## Thermal Characteristics

$R_{\theta JC}$	Thermal Resistance, Junction-to-Case	(Top Source)	2.0	$^{\circ}\text{C}/\text{W}$
$R_{\theta JC}$	Thermal Resistance, Junction-to-Case	(Bottom Drain)	1.1	
$R_{\theta JA}$	Thermal Resistance, Junction-to-Ambient	(Note 1a)	38	
$R_{\theta JA}$	Thermal Resistance, Junction-to-Ambient	(Note 1b)	81	
$R_{\theta JA}$	Thermal Resistance, Junction-to-Ambient	(Note 1c)	26	
$R_{\theta JA}$	Thermal Resistance, Junction-to-Ambient	(Note 1d)	34	
$R_{\theta JA}$	Thermal Resistance, Junction-to-Ambient	(Note 1e)	14	
$R_{\theta JA}$	Thermal Resistance, Junction-to-Ambient	(Note 1f)	16	
$R_{\theta JA}$	Thermal Resistance, Junction-to-Ambient	(Note 1g)	26	
$R_{\theta JA}$	Thermal Resistance, Junction-to-Ambient	(Note 1h)	60	
$R_{\theta JA}$	Thermal Resistance, Junction-to-Ambient	(Note 1i)	15	
$R_{\theta JA}$	Thermal Resistance, Junction-to-Ambient	(Note 1j)	21	
$R_{\theta JA}$	Thermal Resistance, Junction-to-Ambient	(Note 1k)	9	
$R_{\theta JA}$	Thermal Resistance, Junction-to-Ambient	(Note 1l)	11	

### NOTES:

1.  $R_{\theta JA}$  is determined with the device mounted on a FR-4 board using a specified pad of 2 oz copper as shown below.  $R_{\theta CA}$  is determined by the user's board design.



a. 38  $^{\circ}\text{C}/\text{W}$  when mounted on a 1 in<sup>2</sup> pad of 2 oz copper



b. 81  $^{\circ}\text{C}/\text{W}$  when mounted on a minimum pad of 2 oz copper

- c. Still air, 20.9x10.4x12.7mm Aluminum Heat Sink, 1 in<sup>2</sup> pad of 2 oz copper
- d. Still air, 20.9x10.4x12.7mm Aluminum Heat Sink, minimum pad of 2 oz copper
- e. Still air, 45.2x41.4x11.7mm Aavid Thermalloy Part # 10-L41B-11 Heat Sink, 1 in<sup>2</sup> pad of 2 oz copper
- f. Still air, 45.2x41.4x11.7mm Aavid Thermalloy Part # 10-L41B-11 Heat Sink, minimum pad of 2 oz copper
- g. 200FPM Airflow, No Heat Sink, 1 in<sup>2</sup> pad of 2 oz copper
- h. 200FPM Airflow, No Heat Sink, minimum pad of 2 oz copper
- i. 200FPM Airflow, 20.9x10.4x12.7mm Aluminum Heat Sink, 1 in<sup>2</sup> pad of 2 oz copper
- j. 200FPM Airflow, 20.9x10.4x12.7mm Aluminum Heat Sink, minimum pad of 2 oz copper
- k. 200FPM Airflow, 45.2x41.4x11.7mm Aavid Thermalloy Part # 10-L41B-11 Heat Sink, 1 in<sup>2</sup> pad of 2 oz copper
- l. 200FPM Airflow, 45.2x41.4x11.7mm Aavid Thermalloy Part # 10-L41B-11 Heat Sink, minimum pad of 2 oz copper

2. Pulse Test: Pulse Width < 300  $\mu\text{s}$ , Duty cycle < 2.0%.

3.  $E_{AS}$  of 726 mJ is based on starting  $T_j = 25^{\circ}\text{C}$ ; N-ch: L = 3 mH,  $I_{AS} = 22\text{ A}$ ,  $V_{DD} = 150\text{ V}$ ,  $V_{GS} = 10\text{ V}$ . 100% test at L = 0.1 mH,  $I_{AS} = 69\text{ A}$ .

4. Pulsed Id please refer to Fig 11 SOA graph for more details.

5. Computed continuous current limited to Max Junction Temperature only, actual continuous current will be limited by thermal & electro-mechanical application board design.

**Typical Characteristics**  $T_J = 25\text{ }^\circ\text{C}$  unless otherwise noted.

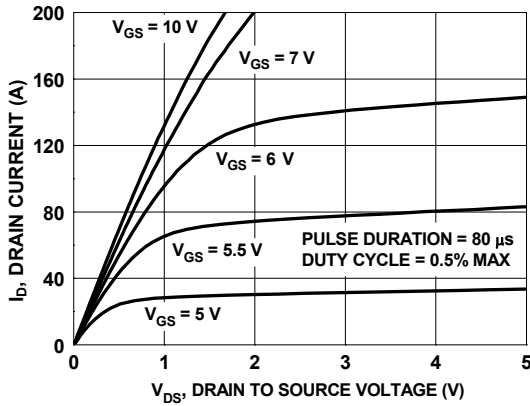


Figure 1. On-Region Characteristics

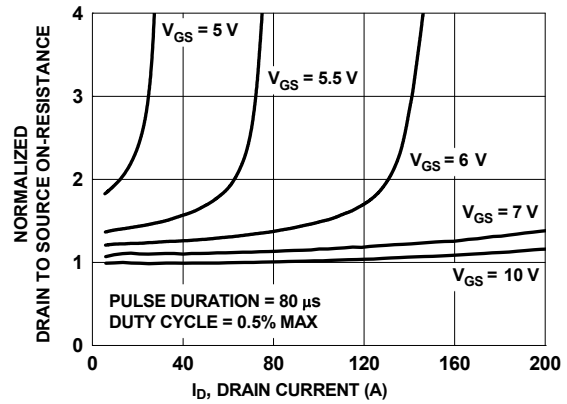


Figure 2. Normalized On-Resistance vs. Drain Current and Gate Voltage

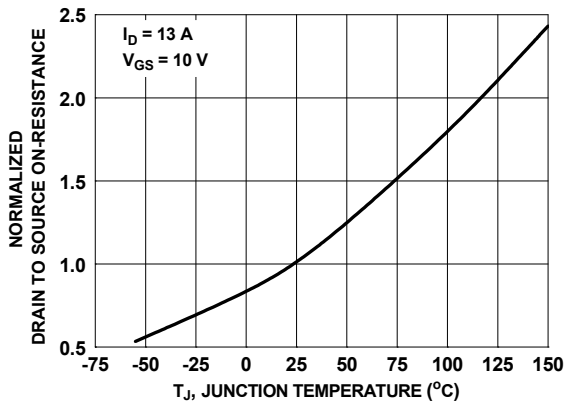


Figure 3. Normalized On-Resistance vs. Junction Temperature

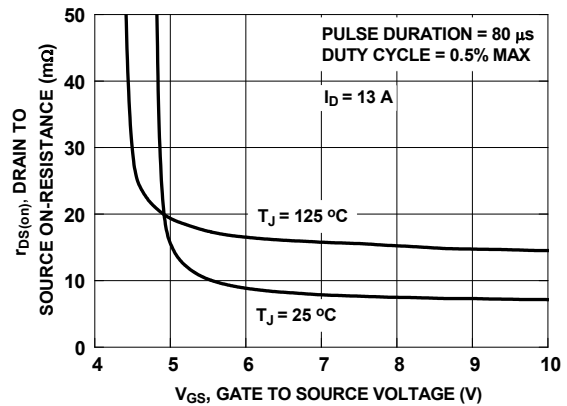


Figure 4. On-Resistance vs. Gate to Source Voltage

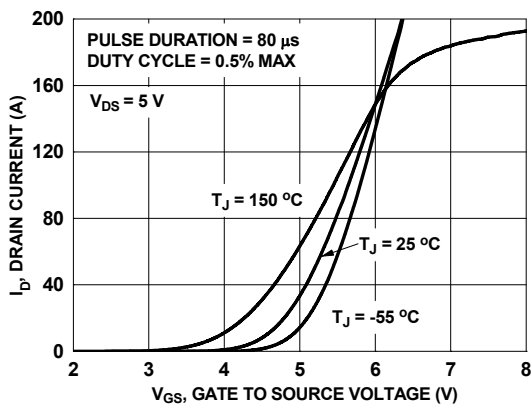


Figure 5. Transfer Characteristics

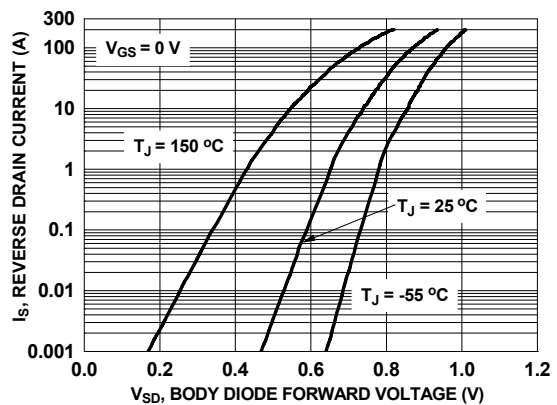
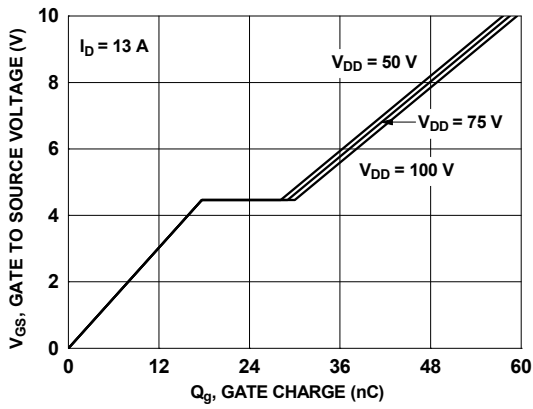
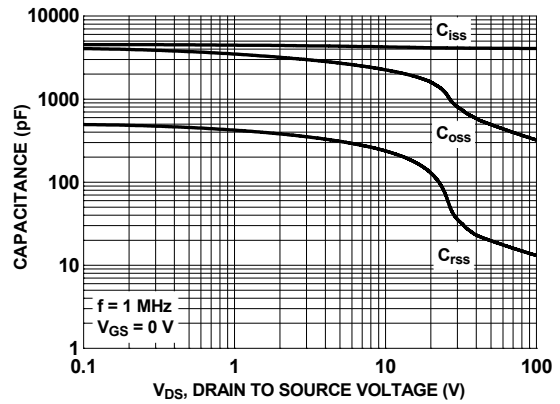


Figure 6. Source to Drain Diode Forward Voltage vs. Source Current

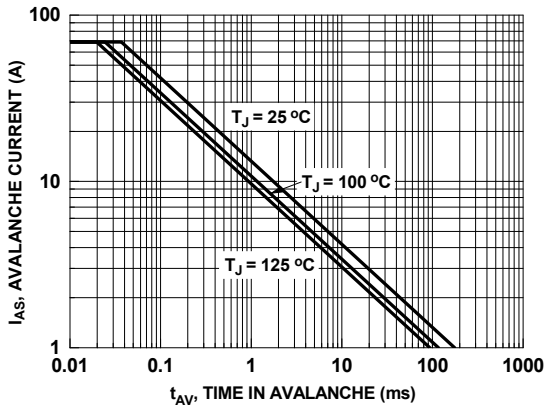
**Typical Characteristics**  $T_J = 25^\circ\text{C}$  unless otherwise noted.



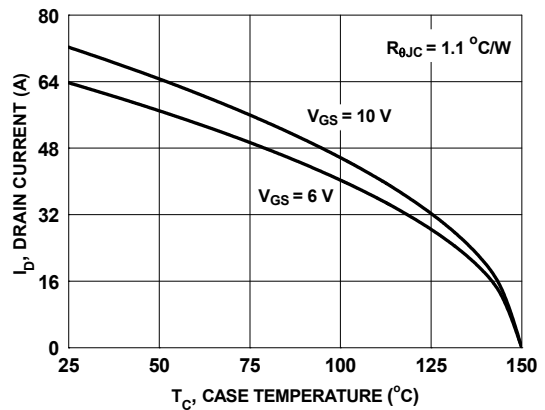
**Figure 7. Gate Charge Characteristics**



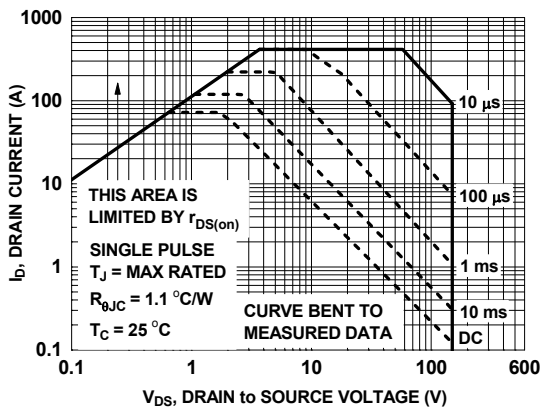
**Figure 8. Capacitance vs. Drain to Source Voltage**



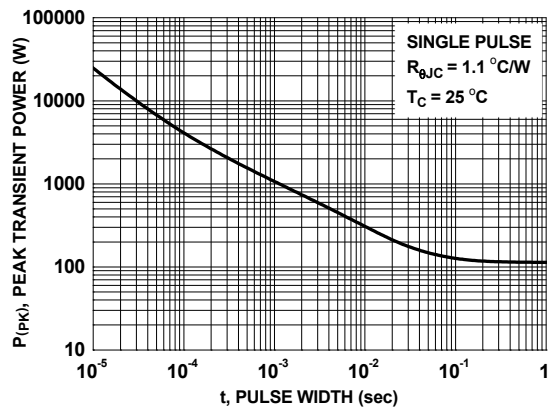
**Figure 9. Unclamped Inductive Switching Capability**



**Figure 10. Maximum Continuous Drain Current vs. Case Temperature**

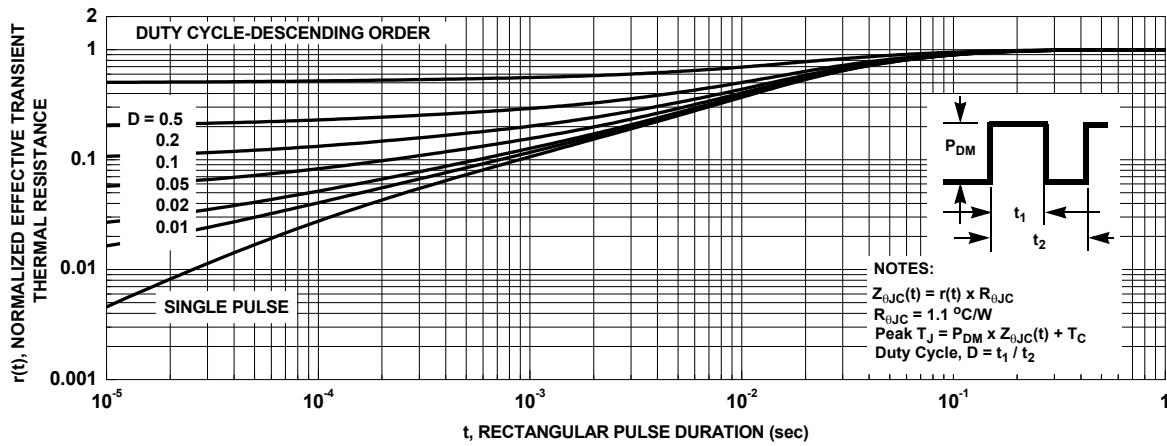


**Figure 11. Forward Bias Safe Operating Area**

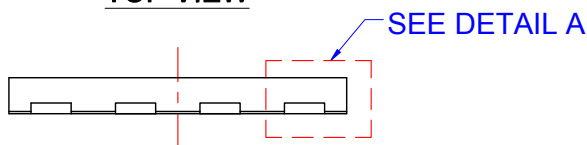
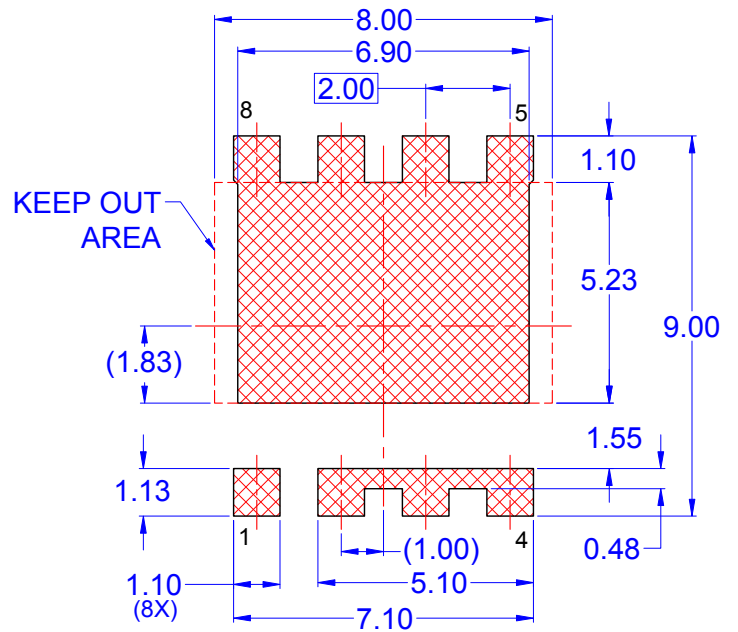
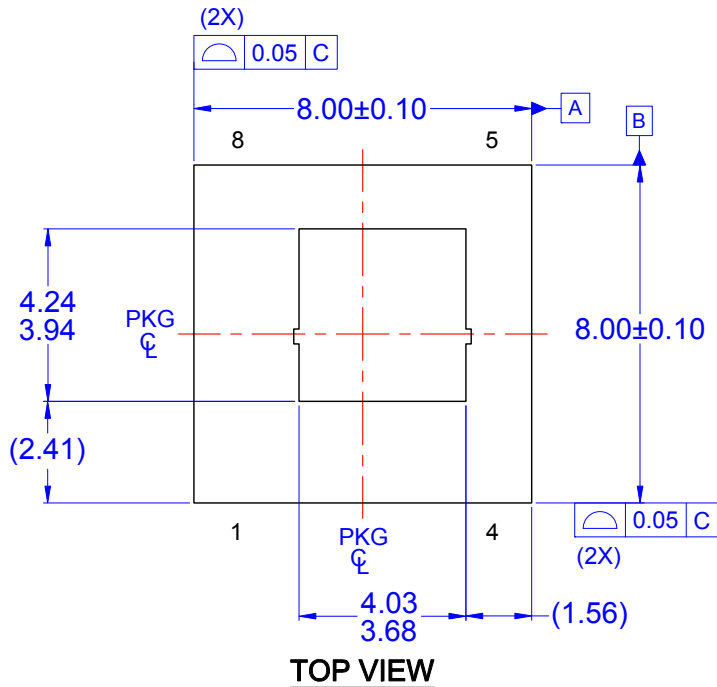


**Figure 12. Single Pulse Maximum Power Dissipation**

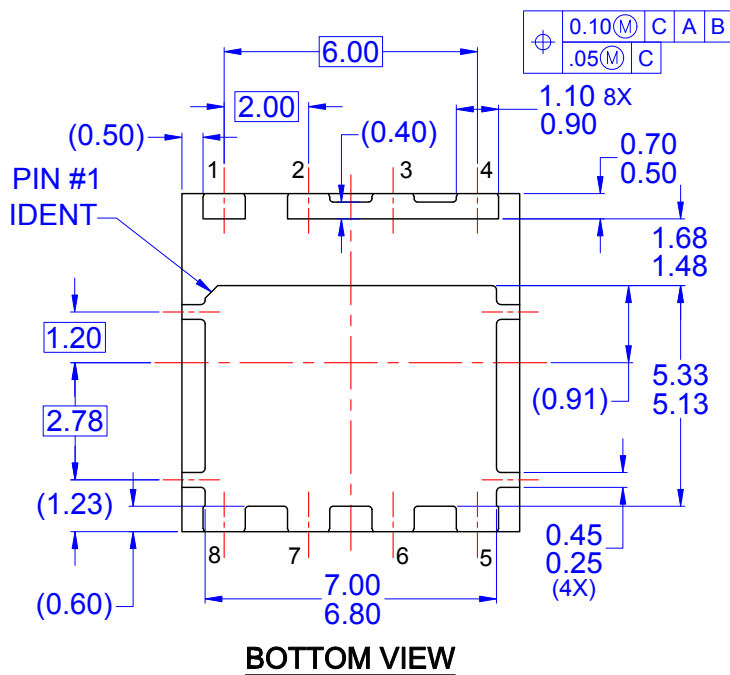
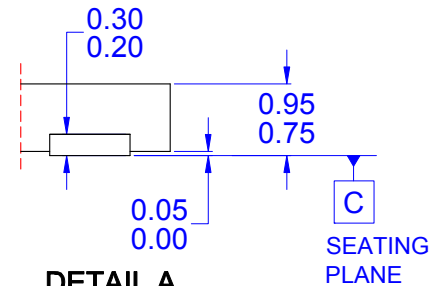
**Typical Characteristics**  $T_J = 25\text{ }^\circ\text{C}$  unless otherwise noted.



**Figure 13. Junction-to-Case Transient Thermal Response Curve**



**LAND PATTERN RECOMMENDATION**



- NOTES: UNLESS OTHERWISE SPECIFIED
- A) THIS PACKAGE IS NOT PRESENTLY REGISTERED WITH ANY STANDARDS COMMITTEE.
  - B) DIMENSIONS ARE INCLUSIVE OF BURRS, MOLD FLASH, AND TIE BAR PROTRUSIONS.
  - C) ALL DIMENSIONS ARE IN MILLIMETERS.
  - D) DRAWING CONFORMS TO ASME Y14.5M-2009.
  - E) IT IS RECOMMENDED TO HAVE NO TRACES OR VIAS WITHIN THE KEEP OUR AREA.
  - F) DRAWING FILENAME: MKT-PQFN08RREV2



ON Semiconductor and  are trademarks of Semiconductor Components Industries, LLC dba ON Semiconductor or its subsidiaries in the United States and/or other countries. ON Semiconductor owns the rights to a number of patents, trademarks, copyrights, trade secrets, and other intellectual property. A listing of ON Semiconductor's product/patent coverage may be accessed at [www.onsemi.com/site/pdf/Patent-Marking.pdf](http://www.onsemi.com/site/pdf/Patent-Marking.pdf). ON Semiconductor reserves the right to make changes without further notice to any products herein. ON Semiconductor makes no warranty, representation or guarantee regarding the suitability of its products for any particular purpose, nor does ON Semiconductor assume any liability arising out of the application or use of any product or circuit, and specifically disclaims any and all liability, including without limitation special, consequential or incidental damages. Buyer is responsible for its products and applications using ON Semiconductor products, including compliance with all laws, regulations and safety requirements or standards, regardless of any support or applications information provided by ON Semiconductor. "Typical" parameters which may be provided in ON Semiconductor data sheets and/or specifications can and do vary in different applications and actual performance may vary over time. All operating parameters, including "Typicals" must be validated for each customer application by customer's technical experts. ON Semiconductor does not convey any license under its patent rights nor the rights of others. ON Semiconductor products are not designed, intended, or authorized for use as a critical component in life support systems or any FDA Class 3 medical devices or medical devices with a same or similar classification in a foreign jurisdiction or any devices intended for implantation in the human body. Should Buyer purchase or use ON Semiconductor products for any such unintended or unauthorized application, Buyer shall indemnify and hold ON Semiconductor and its officers, employees, subsidiaries, affiliates, and distributors harmless against all claims, costs, damages, and expenses, and reasonable attorney fees arising out of, directly or indirectly, any claim of personal injury or death associated with such unintended or unauthorized use, even if such claim alleges that ON Semiconductor was negligent regarding the design or manufacture of the part. ON Semiconductor is an Equal Opportunity/Affirmative Action Employer. This literature is subject to all applicable copyright laws and is not for resale in any manner.

## PUBLICATION ORDERING INFORMATION

### LITERATURE FULFILLMENT:

Literature Distribution Center for ON Semiconductor  
19521 E. 32nd Pkwy, Aurora, Colorado 80011 USA  
**Phone:** 303-675-2175 or 800-344-3860 Toll Free USA/Canada  
**Fax:** 303-675-2176 or 800-344-3867 Toll Free USA/Canada  
**Email:** [orderlit@onsemi.com](mailto:orderlit@onsemi.com)

**N. American Technical Support:** 800-282-9855 Toll Free  
USA/Canada  
**Europe, Middle East and Africa Technical Support:**  
Phone: 421 33 790 2910  
**Japan Customer Focus Center**  
Phone: 81-3-5817-1050

**ON Semiconductor Website:** [www.onsemi.com](http://www.onsemi.com)  
**Order Literature:** <http://www.onsemi.com/orderlit>  
For additional information, please contact your local  
Sales Representative