

## FDP8870

### N-Channel PowerTrench® MOSFET 30V, 156A, 4.1mΩ

#### General Description

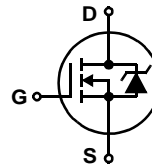
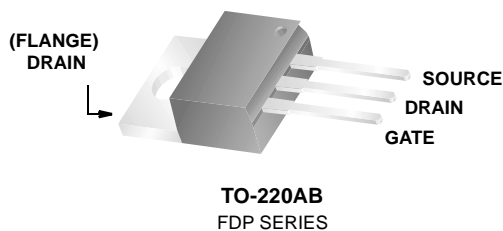
This N-Channel MOSFET has been designed specifically to improve the overall efficiency of DC/DC converters using either synchronous or conventional switching PWM controllers. It has been optimized for low gate charge, low  $r_{DS(ON)}$  and fast switching speed.

#### Features

- $r_{DS(ON)} = 4.1m\Omega$ ,  $V_{GS} = 10V$ ,  $I_D = 35A$
- $r_{DS(ON)} = 4.6m\Omega$ ,  $V_{GS} = 4.5V$ ,  $I_D = 35A$
- High performance trench technology for extremely low  $r_{DS(ON)}$
- Low gate charge
- High power and current handling capability
- RoHS Compliant

#### Applications

- DC/DC converters



#### MOSFET Maximum Ratings $T_C = 25^\circ C$ unless otherwise noted

Symbol	Parameter	Ratings	Units
$V_{DSS}$	Drain to Source Voltage	30	V
$V_{GS}$	Gate to Source Voltage	$\pm 20$	V
$I_D$	Drain Current		
	Continuous ( $T_C = 25^\circ C$ , $V_{GS} = 10V$ ) (Note 1)	156	A
	Continuous ( $T_C = 25^\circ C$ , $V_{GS} = 4.5V$ ) (Note 1)	147	A
	Continuous ( $T_{amb} = 25^\circ C$ , $V_{GS} = 10V$ , with $R_{\theta JA} = 62^\circ C/W$ )	19	A
	Pulsed	Figure 4	A
$E_{AS}$	Single Pulse Avalanche Energy (Note 2)	300	mJ
$P_D$	Power dissipation	160	W
	Derate above $25^\circ C$	1.07	$W/^\circ C$
$T_J, T_{STG}$	Operating and Storage Temperature	-55 to 175	$^\circ C$

#### Thermal Characteristics

$R_{\theta JC}$	Thermal Resistance Junction to Case TO-220	0.94	$^\circ C/W$
$R_{\theta JA}$	Thermal Resistance Junction to Ambient TO-220 ( Note 3)	62	$^\circ C/W$

#### Package Marking and Ordering Information

Device Marking	Device	Package	Reel Size	Tape Width	Quantity
FDP8870	FDP8870	TO-220AB	Tube	N/A	50 units

**Electrical Characteristics**  $T_C = 25^\circ\text{C}$  unless otherwise noted

Symbol	Parameter	Test Conditions	Min	Typ	Max	Units
--------	-----------	-----------------	-----	-----	-----	-------

**Off Characteristics**

$B_{VDSS}$	Drain to Source Breakdown Voltage	$I_D = 250\mu\text{A}$ , $V_{GS} = 0\text{V}$	30	-	-	V
$I_{DSS}$	Zero Gate Voltage Drain Current	$V_{DS} = 24\text{V}$ $V_{GS} = 0\text{V}$ $T_C = 150^\circ\text{C}$	-	-	1	$\mu\text{A}$
$I_{GSS}$	Gate to Source Leakage Current	$V_{GS} = \pm 20\text{V}$	-	-	$\pm 100$	nA

**On Characteristics**

$V_{GS(TH)}$	Gate to Source Threshold Voltage	$V_{GS} = V_{DS}$ , $I_D = 250\mu\text{A}$	1.2	-	2.5	V
$r_{DS(ON)}$	Drain to Source On Resistance	$I_D = 35\text{A}$ , $V_{GS} = 10\text{V}$	-	0.0034	0.0041	$\Omega$
		$I_D = 35\text{A}$ , $V_{GS} = 4.5\text{V}$	-	0.0040	0.0046	
		$I_D = 35\text{A}$ , $V_{GS} = 10\text{V}$ , $T_J = 175^\circ\text{C}$	-	0.0051	0.0065	

**Dynamic Characteristics**

$C_{ISS}$	Input Capacitance	$V_{DS} = 15\text{V}$ , $V_{GS} = 0\text{V}$ , $f = 1\text{MHz}$	-	5200	-	pF	
$C_{OSS}$	Output Capacitance		-	970	-	pF	
$C_{RSS}$	Reverse Transfer Capacitance		-	570	-	pF	
$R_G$	Gate Resistance	$V_{GS} = 0.5\text{V}$ , $f = 1\text{MHz}$	-	2.1	-	$\Omega$	
$Q_{g(TOT)}$	Total Gate Charge at 10V	$V_{GS} = 0\text{V}$ to 10V	$V_{DD} = 15\text{V}$ $I_D = 35\text{A}$ $I_g = 1.0\text{mA}$	-	106	132	nC
$Q_{g(5)}$	Total Gate Charge at 5V	$V_{GS} = 0\text{V}$ to 5V		-	56	69	nC
$Q_{g(TH)}$	Threshold Gate Charge	$V_{GS} = 0\text{V}$ to 1V		-	5.0	6.5	nC
$Q_{gs}$	Gate to Source Gate Charge			-	15	-	nC
$Q_{gs2}$	Gate Charge Threshold to Plateau			-	10	-	nC
$Q_{gd}$	Gate to Drain "Miller" Charge			-	23	-	nC

**Switching Characteristics** ( $V_{GS} = 10\text{V}$ )

$t_{ON}$	Turn-On Time	$V_{DD} = 15\text{V}$ , $I_D = 35\text{A}$ $V_{GS} = 4.5\text{V}$ , $R_{GS} = 3.3\Omega$	-	-	168	ns
$t_{d(ON)}$	Turn-On Delay Time		-	11	-	ns
$t_r$	Rise Time		-	105	-	ns
$t_{d(OFF)}$	Turn-Off Delay Time		-	70	-	ns
$t_f$	Fall Time		-	46	-	ns
$t_{OFF}$	Turn-Off Time		-	-	173	ns

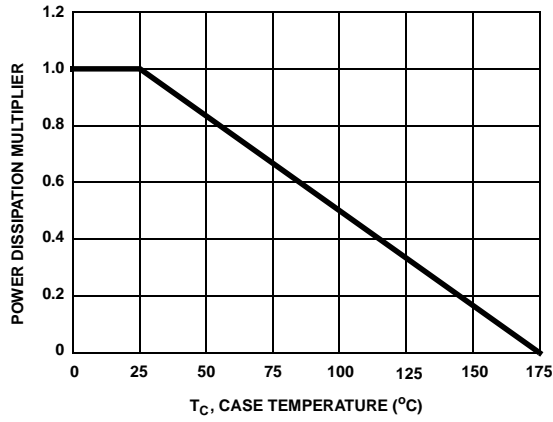
**Drain-Source Diode Characteristics**

$V_{SD}$	Source to Drain Diode Voltage	$I_{SD} = 35\text{A}$	-	-	1.25	V
		$I_{SD} = 15\text{A}$	-	-	1.0	V
$t_{rr}$	Reverse Recovery Time	$I_{SD} = 35\text{A}$ , $di_{SD}/dt = 100\text{A}/\mu\text{s}$	-	-	37	ns
$Q_{RR}$	Reverse Recovered Charge	$I_{SD} = 35\text{A}$ , $di_{SD}/dt = 100\text{A}/\mu\text{s}$	-	-	21	nC

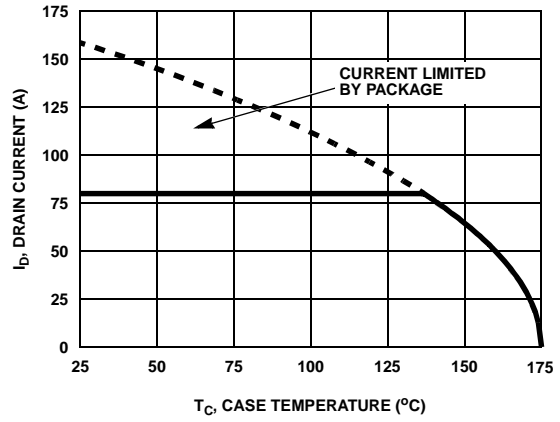
**Notes:**

- 1: Package current limitation is 80A.
- 2: Starting  $T_J = 25^\circ\text{C}$ ,  $L = 0.15\text{mH}$ ,  $I_{AS} = 64\text{A}$ ,  $V_{DD} = 27\text{V}$ ,  $V_{GS} = 10\text{V}$ .
- 3: Pulse width = 100s.

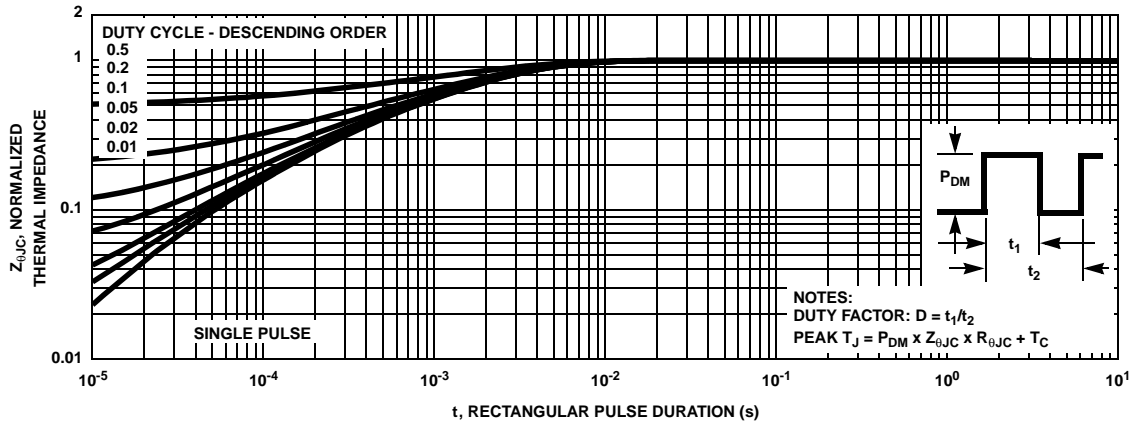
**Typical Characteristics**  $T_C = 25^\circ\text{C}$  unless otherwise noted



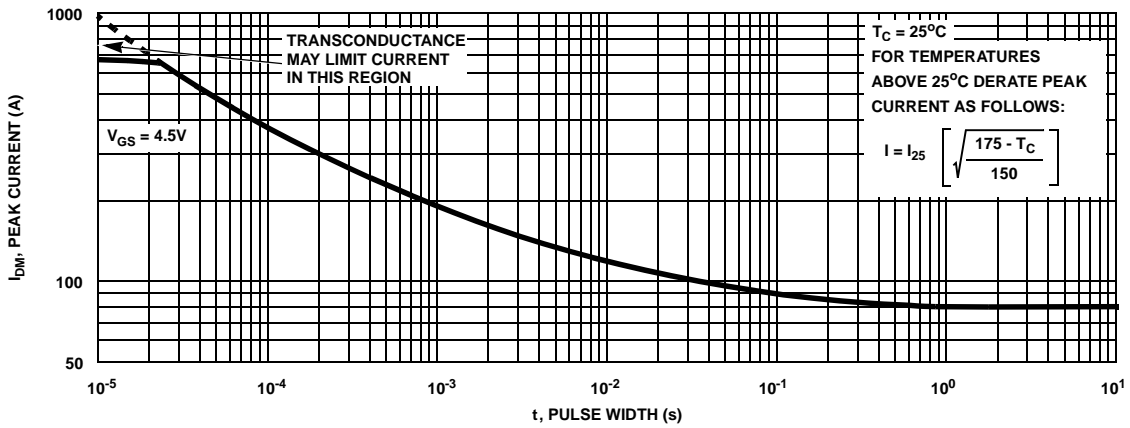
**Figure 1. Normalized Power Dissipation vs Case Temperature**



**Figure 2. Maximum Continuous Drain Current vs Case Temperature**

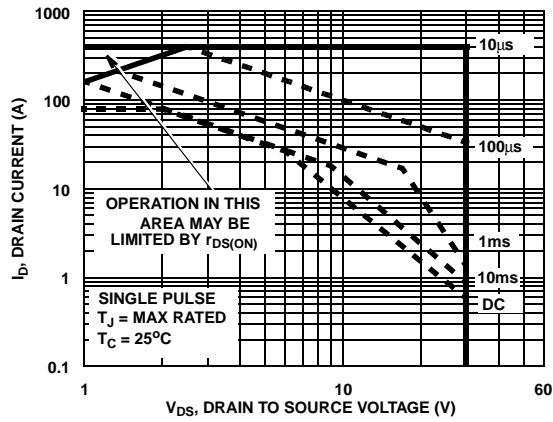


**Figure 3. Normalized Maximum Transient Thermal Impedance**

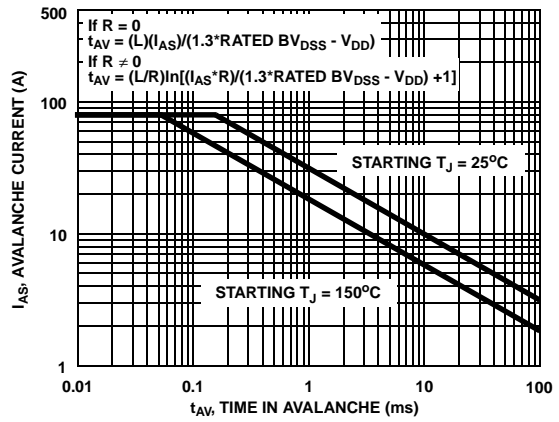


**Figure 4. Peak Current Capability**

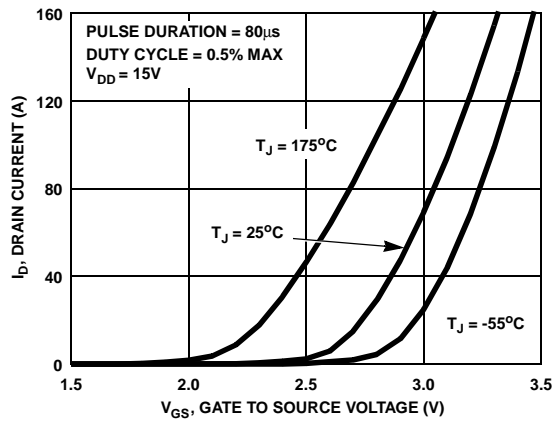
**Typical Characteristics**  $T_C = 25^\circ\text{C}$  unless otherwise noted



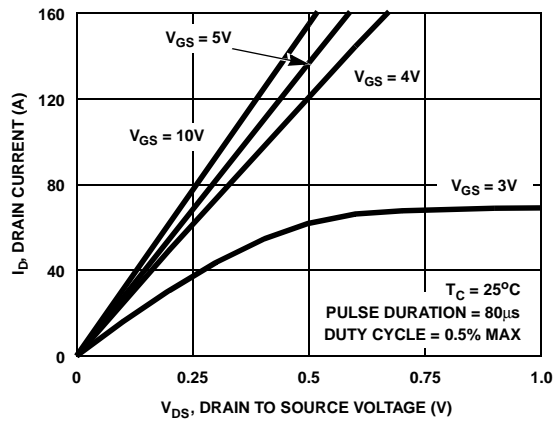
**Figure 5. Forward Bias Safe Operating Area**



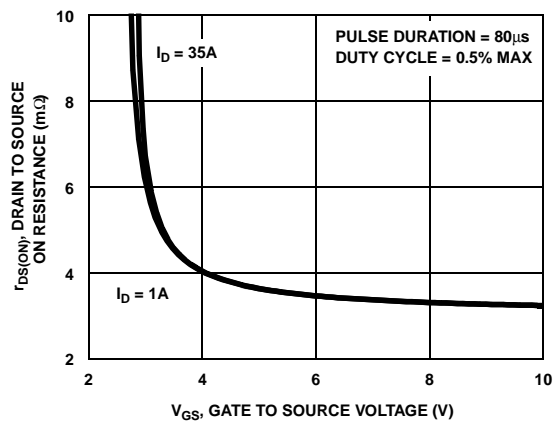
NOTE: Refer to Fairchild Application Notes AN7514 and AN7515  
**Figure 6. Unclamped Inductive Switching Capability**



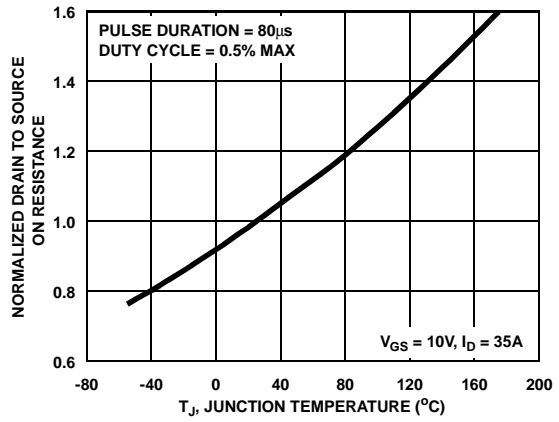
**Figure 7. Transfer Characteristics**



**Figure 8. Saturation Characteristics**

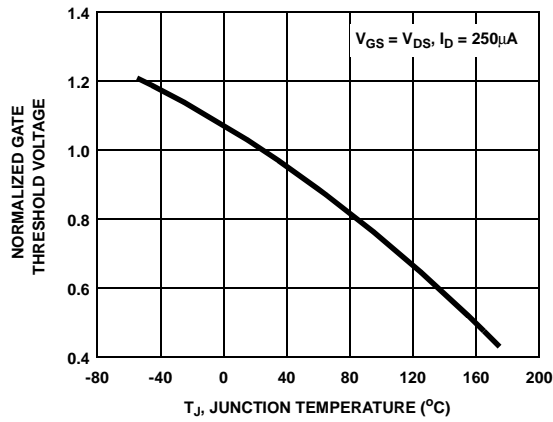


**Figure 9. Drain to Source On Resistance vs Gate Voltage and Drain Current**

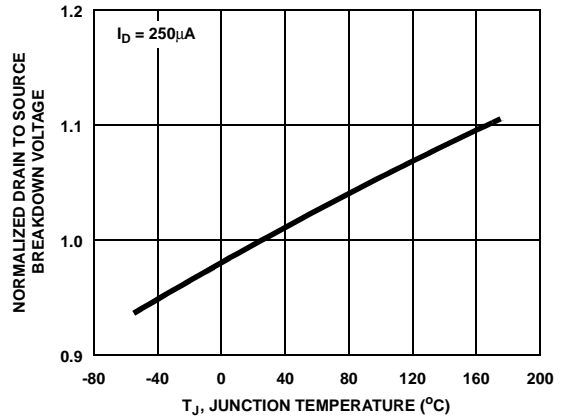


**Figure 10. Normalized Drain to Source On Resistance vs Junction Temperature**

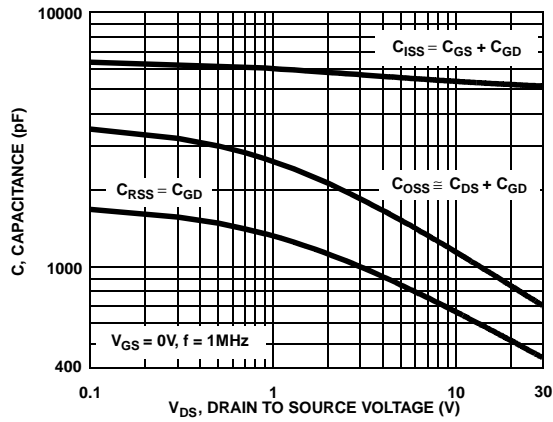
**Typical Characteristics**  $T_C = 25^\circ\text{C}$  unless otherwise noted



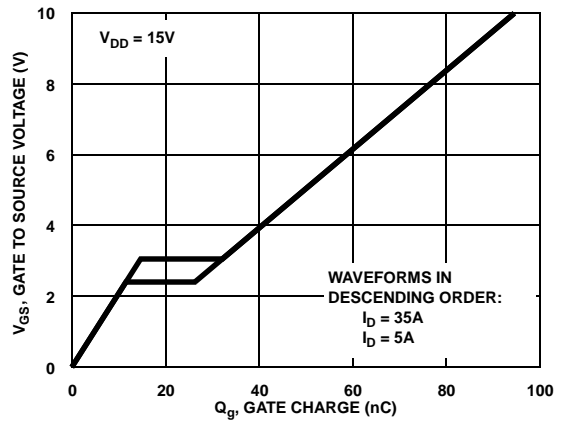
**Figure 11. Normalized Gate Threshold Voltage vs Junction Temperature**



**Figure 12. Normalized Drain to Source Breakdown Voltage vs Junction Temperature**



**Figure 13. Capacitance vs Drain to Source Voltage**



**Figure 14. Gate Charge Waveforms for Constant Gate Current**

Test Circuits and Waveforms



Figure 15. Unclamped Energy Test Circuit



Figure 16. Unclamped Energy Waveforms



Figure 17. Gate Charge Test Circuit



Figure 18. Gate Charge Waveforms



Figure 19. Switching Time Test Circuit

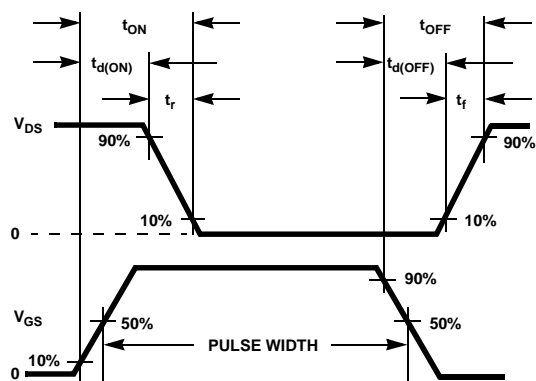


Figure 20. Switching Time Waveforms

## PSPICE Electrical Model

.SUBCKT FDP8870 2 1 3 ; rev December 2003

Ca 12 8 4.5e-9

Cb 15 14 4.5e-9

Cin 6 8 4.7e-9

Dbody 7 5 DbodyMOD  
 Dbreak 5 11 DbreakMOD  
 Dplcap 10 5 DplcapMOD

Ebreak 11 7 17 18 33.45  
 Eds 14 8 5 8 1  
 Egs 13 8 6 8 1  
 Esg 6 10 6 8 1  
 Evthres 6 21 19 8 1  
 Evtemp 20 6 18 22 1

It 8 17 1

Lgate 1 9 3.6e-9  
 Ldrain 2 5 1.0e-9  
 Lsource 3 7 3.3e-9

RLgate 1 9 36  
 RLdrain 2 5 10  
 RLsource 3 7 33

Mmed 16 6 8 8 MmedMOD  
 Mstro 16 6 8 8 MstroMOD  
 Mweak 16 21 8 8 MweakMOD

Rbreak 17 18 RbreakMOD 1  
 Rdrain 50 16 RdrainMOD 2.15e-3  
 Rgate 9 20 2.1  
 RSLC1 5 51 RSLCMOD 1e-6  
 RSLC2 5 50 1e3  
 Rsource 8 7 RsourceMOD 9e-4  
 Rvthres 22 8 RvthresMOD 1  
 Rvtemp 18 19 RvtempMOD 1  
 S1a 6 12 13 8 S1AMOD  
 S1b 13 12 13 8 S1BMOD  
 S2a 6 15 14 13 S2AMOD  
 S2b 13 15 14 13 S2BMOD

Vbat 22 19 DC 1

ESLC 51 50 VALUE={{(V(5,51)/ABS(V(5,51)))\*(PWR(V(5,51))/(1e-6\*500),10))}}

.MODEL DbodyMOD D (IS=7.5E-12 IKF=17 N=1.01 RS=2.1e-3 TRS1=2e-3 TRS2=2e-7  
 + CJO=1.9e-9 M=0.57 TT=9e-11 XT1=2.6)

.MODEL DbreakMOD D (RS=8e-2 TRS1=1e-3 TRS2=-8.9e-6)

.MODEL DplcapMOD D (CJO=1.75e-9 IS=1e-30 N=10 M=0.4)

.MODEL MmedMOD NMOS (VTO=2.1 KP=30 IS=1e-30 N=10 TOX=1 L=1u W=1u RG=2.1 T\_ABS=25)

.MODEL MstroMOD NMOS (VTO=2.51 KP=650 IS=1e-30 N=10 TOX=1 L=1u W=1u T\_ABS=25)

.MODEL MweakMOD NMOS (VTO=1.67 KP=0.1 IS=1e-30 N=10 TOX=1 L=1u W=1u RG=21 RS=0.1 T\_ABS=25)

.MODEL RbreakMOD RES (TC1=8.3e-4 TC2=-9e-7)

.MODEL RdrainMOD RES (TC1=2.3e-3 TC2=5e-6)

.MODEL RSLCMOD RES (TC1=1e-4 TC2=1e-6)

.MODEL RsourceMOD RES (TC1=8e-3 TC2=1e-6)

.MODEL RvthresMOD RES (TC1=-2.3e-3 TC2=-9e-6)

.MODEL RvtempMOD RES (TC1=-3e-3 TC2=2e-7)

.MODEL S1AMOD VSWITCH (RON=1e-5 ROFF=0.1 VON=-4 VOFF=-2)

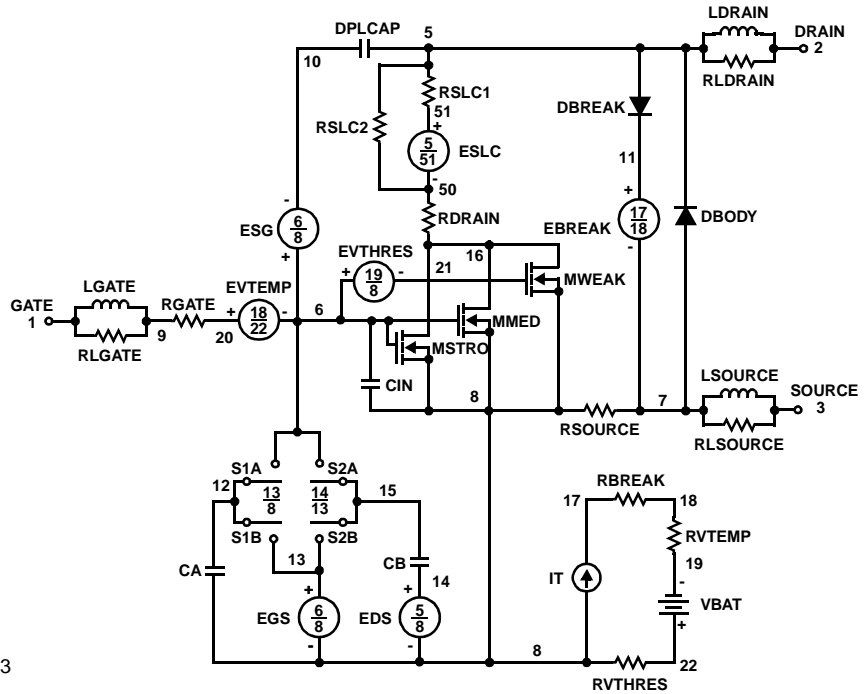
.MODEL S1BMOD VSWITCH (RON=1e-5 ROFF=0.1 VON=-2 VOFF=-4)

.MODEL S2AMOD VSWITCH (RON=1e-5 ROFF=0.1 VON=-1 VOFF=-0.5)

.MODEL S2BMOD VSWITCH (RON=1e-5 ROFF=0.1 VON=-0.5 VOFF=-1)

.ENDS

Note: For further discussion of the PSPICE model, consult **A New PSPICE Sub-Circuit for the Power MOSFET Featuring Global Temperature Options**; IEEE Power Electronics Specialist Conference Records, 1991, written by William J. Hepp and C. Frank Wheatley.



### SABER Electrical Model

```

rev December 2003
template FDP8870 n2,n1,n3 =m_temp
electrical n2,n1,n3
number m_temp=25
{
var i iscl
dp..model dbodymod = (isl=7.5e-12,ikf=17,nl=1.01,rs=2.1e-3,trs1=2e-3,trs2=2e-7,cjo=1.9e-9,m=0.57,tt=9e-11,xti=2.6)
dp..model dbreakmod = (rs=8e-2,trs1=1e-3,trs2=-8.9e-6)
dp..model dplcapmod = (cjo=1.75e-9,isl=10e-30,nl=10,m=0.4)
m..model mmedmod = (type=_n,vto=2.1,kp=30, is=1e-30, tox=1)
m..model mstrongmod = (type=_n,vto=2.51,kp=650, is=1e-30, tox=1)
m..model mweakmod = (type=_n,vto=1.67,kp=0.1, is=1e-30, tox=1,rs=0.1)
sw_vcsp..model s1amod = (ron=1e-5,roff=0.1,von=-4,voff=-2)
sw_vcsp..model s1bmod = (ron=1e-5,roff=0.1,von=-2,voff=-4)
sw_vcsp..model s2amod = (ron=1e-5,roff=0.1,von=-1,voff=-0.5)
sw_vcsp..model s2bmod = (ron=1e-5,roff=0.1,von=-0.5,voff=-1)
c.ca n12 n8 = 4.5e-9
c.cb n15 n14 = 4.5e-9
c.cin n6 n8 = 4.7e-9

```

```

dp.dbody n7 n5 = model=dbodymod
dp.dbreak n5 n11 = model=dbreakmod
dp.dplcap n10 n5 = model=dplcapmod

```

```

spe.ebreak n11 n7 n17 n18 = 33.45
spe.eds n14 n8 n5 n8 = 1
spe.egs n13 n8 n6 n8 = 1
spe.esg n6 n10 n6 n8 = 1
spe.evthres n6 n21 n19 n8 = 1
spe.evtemp n20 n6 n18 n22 = 1

```

```
i.it n8 n17 = 1
```

```

l.lgate n1 n9 = 3.6e-9
l.ldrain n2 n5 = 1.0e-9
l.lsource n3 n7 = 3.3e-9

```

```

res.rlgate n1 n9 = 36
res.rldrain n2 n5 = 10
res.rlsource n3 n7 = 33

```

```

m.mmed n16 n6 n8 n8 = model=mmedmod, l=1u, w=1u, temp=m_temp
m.mstrong n16 n6 n8 n8 = model=mstrongmod, l=1u, w=1u, temp=m_temp
m.mweak n16 n21 n8 n8 = model=mweakmod, l=1u, w=1u, temp=m_temp

```

```

res.rbreak n17 n18 = 1, tc1=8.3e-4,tc2=-9e-7
res.rdrain n50 n16 = 2.15e-3, tc1=2.3e-3,tc2=5e-6
res.rgate n9 n20 = 2.1
res.rslc1 n5 n51 = 1e-6, tc1=1e-4,tc2=1e-6
res.rslc2 n5 n50 = 1e3
res.rsource n8 n7 = 9e-4, tc1=8e-3,tc2=1e-6
res.rvthres n22 n8 = 1, tc1=-2.3e-3,tc2=-9e-6
res.rvtemp n18 n19 = 1, tc1=-3e-3,tc2=2e-7
sw_vcsp.s1a n6 n12 n13 n8 = model=s1amod
sw_vcsp.s1b n13 n12 n13 n8 = model=s1bmod
sw_vcsp.s2a n6 n15 n14 n13 = model=s2amod
sw_vcsp.s2b n13 n15 n14 n13 = model=s2bmod

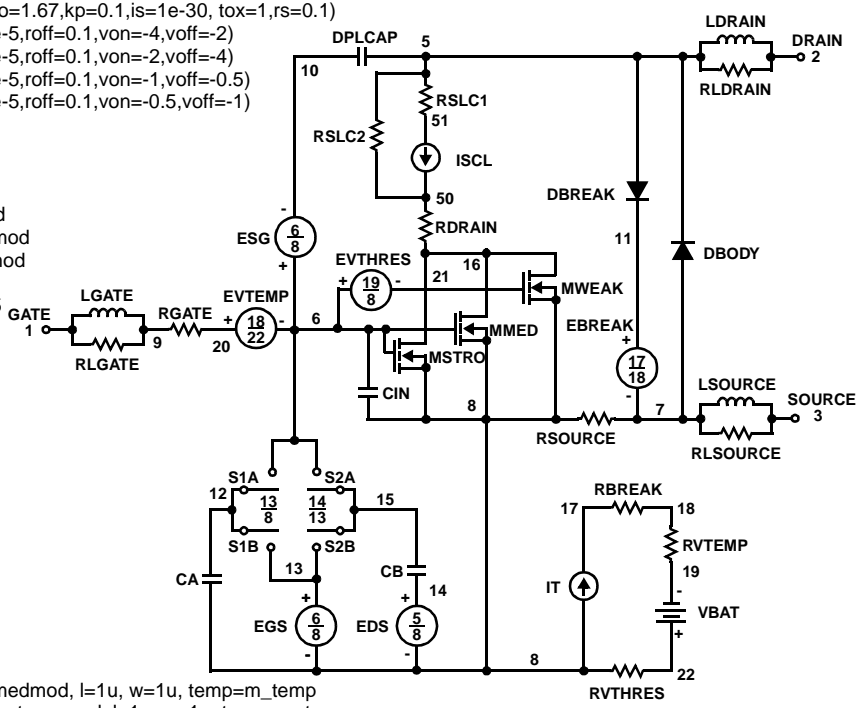
```

```
v.vbat n22 n19 = dc=1
```

```

equations {
i (n51->n50) +=iscl
iscl: v(n51,n50) = ((v(n5,n51)/(1e-9+abs(v(n5,n51)))))*((abs(v(n5,n51))*1e6/500)** 10)
}
}

```





### PSPICE Thermal Model

REV 23 December 2003

FDP8870T

CTHERM1 TH 6 1e-3  
 CHERM2 6 5 2e-3  
 CHERM3 5 4 3e-3  
 CHERM4 4 3 9e-3  
 CHERM5 3 2 1e-2  
 CHERM6 2 TL 2e-2

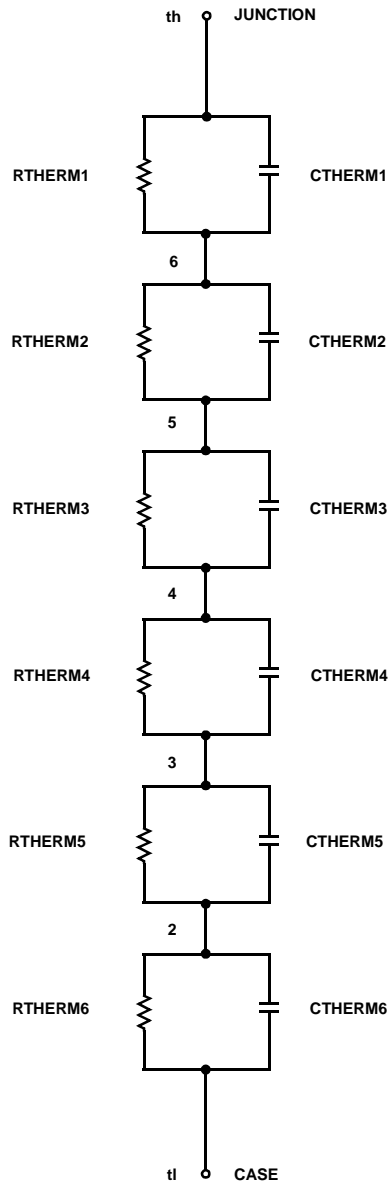
RHERM1 TH 6 3e-2  
 RHERM2 6 5 8e-2  
 RHERM3 5 4 1.1e-1  
 RHERM4 4 3 1.6e-1  
 RHERM5 3 2 1.72e-1  
 RHERM6 2 TL 2e-1

### SABER Thermal Model

SABER thermal model FDP8870T  
 template thermal\_model th tl  
 thermal\_c th, tl

```
{
ctherm.ctherm1 th 6 =1e-3
ctherm.ctherm2 6 5 =2e-3
ctherm.ctherm3 5 4 =3e-3
ctherm.ctherm4 4 3 =9e-3
ctherm.ctherm5 3 2 =1e-2
ctherm.ctherm6 2 tl =2e-2
```





```
rtherm.rtherm1 th 6 =3e-2
rtherm.rtherm2 6 5 =8e-2
rtherm.rtherm3 5 4 =1.1e-1
rtherm.rtherm4 4 3 =1.6e-1
rtherm.rtherm5 3 2 =1.72e-1
rtherm.rtherm6 2 tl =2e-1
}
```





**TRADEMARKS**

The following includes registered and unregistered trademarks and service marks, owned by Fairchild Semiconductor and/or its global subsidiaries, and is not intended to be an exhaustive list of all such trademarks.

- |   |   |   |   |
|---|---|---|---|
| ACEx®   | FPS™  | PDP-SPM™  | The Power Franchise®  |
| Build it Now™   | F-PFS™  | Power-SPM™  | <b>power</b><br>the franchise   |
| CorePLUS™   | FRFET®  | PowerTrench®  | TinyBoost™  |
| CorePOWER™  | Global Power ResourceSM   | Programmable Active Droop™  | TinyBuck™   |
| CROSSVOLT™  | Green FPS™  | QFET®   | TinyLogic®  |
| CTL™  | Green FPS™ e-Series™  | QS™   | TINYOPTO™   |
| Current Transfer Logic™   | GTO™  | Quiet Series™   | TinyPower™  |
| EcoSPARK®   | IntelliMAX™   | RapidConfigure™   | TinyPWM™  |
| EfficientMax™   | ISOPLANAR™  | Saving our world 1mW at a time™   | TinyWire™   |
| EZSWITCH™ *   | MegaBuck™   | SmartMax™   | µSerDes™  |
|  | MICROCOUPLER™   | SMART START™  |  |
|  | MicroFET™   | SPM®  | UHC®  |
| Fairchild®  | MicroPak™   | STEALTH™  | Ultra FRFET™  |
| Fairchild Semiconductor®  | MillerDrive™  | SuperFET™   | UniFET™   |
| FACT Quiet Series™  | MotionMax™  | SuperSOT™-3   | VCX™  |
| FACT®   | Motion-SPM™   | SuperSOT™-6   | VisualMax™  |
| FAST®   | OPTOLOGIC®  | SuperSOT™-8   |   |
| FastvCore™  | OPTOPLANAR®   | SuperMOS™   |   |
| FlashWriter® *  |  |  |   |

\* EZSWITCH™ and FlashWriter® are trademarks of System General Corporation, used under license by Fairchild Semiconductor.

**DISCLAIMER**

FAIRCHILD SEMICONDUCTOR RESERVES THE RIGHT TO MAKE CHANGES WITHOUT FURTHER NOTICE TO ANY PRODUCTS HEREIN TO IMPROVE RELIABILITY, FUNCTION, OR DESIGN. FAIRCHILD DOES NOT ASSUME ANY LIABILITY ARISING OUT OF THE APPLICATION OR USE OF ANY PRODUCT OR CIRCUIT DESCRIBED HEREIN; NEITHER DOES IT CONVEY ANY LICENSE UNDER ITS PATENT RIGHTS, NOR THE RIGHTS OF OTHERS. THESE SPECIFICATIONS DO NOT EXPAND THE TERMS OF FAIRCHILD'S WORLDWIDE TERMS AND CONDITIONS, SPECIFICALLY THE WARRANTY THEREIN, WHICH COVERS THESE PRODUCTS.

**LIFE SUPPORT POLICY**

FAIRCHILD'S PRODUCTS ARE NOT AUTHORIZED FOR USE AS CRITICAL COMPONENTS IN LIFE SUPPORT DEVICES OR SYSTEMS WITHOUT THE EXPRESS WRITTEN APPROVAL OF FAIRCHILD SEMICONDUCTOR CORPORATION.

As used herein:

- Life support devices or systems are devices or systems which, (a) are intended for surgical implant into the body or (b) support or sustain life, and (c) whose failure to perform when properly used in accordance with instructions for use provided in the labeling, can be reasonably expected to result in a significant injury of the user.
- A critical component in any component of a life support, device, or system whose failure to perform can be reasonably expected to cause the failure of the life support device or system, or to affect its safety or effectiveness.

**PRODUCT STATUS DEFINITIONS**

**Definition of Terms**

Datasheet Identification	Product Status	Definition
Advance Information	Formative or In Design	This datasheet contains the design specifications for product development. Specifications may change in any manner without notice.
Preliminary	First Production	This datasheet contains preliminary data; supplementary data will be published at a later date. Fairchild Semiconductor reserves the right to make changes at any time without notice to improve design.
No Identification Needed	Full Production	This datasheet contains final specifications. Fairchild Semiconductor reserves the right to make changes at any time without notice to improve the design.
Obsolete	Not In Production	This datasheet contains specifications on a product that is discontinued by Fairchild Semiconductor. The datasheet is for reference information only.

ON Semiconductor and  are trademarks of Semiconductor Components Industries, LLC dba ON Semiconductor or its subsidiaries in the United States and/or other countries. ON Semiconductor owns the rights to a number of patents, trademarks, copyrights, trade secrets, and other intellectual property. A listing of ON Semiconductor's product/patent coverage may be accessed at [www.onsemi.com/site/pdf/Patent-Marking.pdf](http://www.onsemi.com/site/pdf/Patent-Marking.pdf). ON Semiconductor reserves the right to make changes without further notice to any products herein. ON Semiconductor makes no warranty, representation or guarantee regarding the suitability of its products for any particular purpose, nor does ON Semiconductor assume any liability arising out of the application or use of any product or circuit, and specifically disclaims any and all liability, including without limitation special, consequential or incidental damages. Buyer is responsible for its products and applications using ON Semiconductor products, including compliance with all laws, regulations and safety requirements or standards, regardless of any support or applications information provided by ON Semiconductor. "Typical" parameters which may be provided in ON Semiconductor data sheets and/or specifications can and do vary in different applications and actual performance may vary over time. All operating parameters, including "Typicals" must be validated for each customer application by customer's technical experts. ON Semiconductor does not convey any license under its patent rights nor the rights of others. ON Semiconductor products are not designed, intended, or authorized for use as a critical component in life support systems or any FDA Class 3 medical devices or medical devices with a same or similar classification in a foreign jurisdiction or any devices intended for implantation in the human body. Should Buyer purchase or use ON Semiconductor products for any such unintended or unauthorized application, Buyer shall indemnify and hold ON Semiconductor and its officers, employees, subsidiaries, affiliates, and distributors harmless against all claims, costs, damages, and expenses, and reasonable attorney fees arising out of, directly or indirectly, any claim of personal injury or death associated with such unintended or unauthorized use, even if such claim alleges that ON Semiconductor was negligent regarding the design or manufacture of the part. ON Semiconductor is an Equal Opportunity/Affirmative Action Employer. This literature is subject to all applicable copyright laws and is not for resale in any manner.

## PUBLICATION ORDERING INFORMATION

### LITERATURE FULFILLMENT:

Literature Distribution Center for ON Semiconductor  
19521 E. 32nd Pkwy, Aurora, Colorado 80011 USA  
**Phone:** 303-675-2175 or 800-344-3860 Toll Free USA/Canada  
**Fax:** 303-675-2176 or 800-344-3867 Toll Free USA/Canada  
**Email:** [orderlit@onsemi.com](mailto:orderlit@onsemi.com)

**N. American Technical Support:** 800-282-9855 Toll Free  
USA/Canada  
**Europe, Middle East and Africa Technical Support:**  
Phone: 421 33 790 2910  
**Japan Customer Focus Center**  
Phone: 81-3-5817-1050

**ON Semiconductor Website:** [www.onsemi.com](http://www.onsemi.com)  
**Order Literature:** <http://www.onsemi.com/orderlit>  
For additional information, please contact your local  
Sales Representative