

MOSFET – N-Channel, UniFET™

60 V, 55 A, 22 mΩ

FDP55N06 / FDPF55N06

Description

UniFET MOSFET is onsemi's high voltage MOSFET family based on planar stripe and DMOS technology. This MOSFET is tailored to reduce on-state resistance, and to provide better switching performance and higher avalanche energy strength. This device family is suitable for switching power converter applications such as power factor correction (PFC), flat panel display (FPD) TV power, ATX and electronic lamp ballasts.

Features

- $R_{DS(on)} = 22\text{ m}\Omega$ (Typ.) @ $V_{GS} = 10\text{ V}$, $I_D = 27.5\text{ A}$
- Low Gate Charge (Typ. 30 nC)
- Low C_{rss} (Typ. 60 pF)
- 100% Avalanche Tested

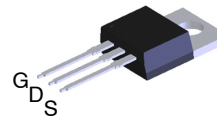
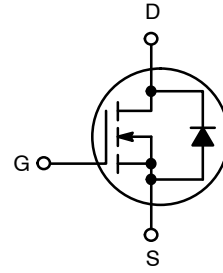

TO-220-3LD
CASE 340AT

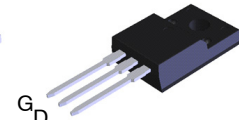

TO-220 Fullpack, 3-Lead
/ TO-220F-3SG
CASE 221AT

MARKING DIAGRAM

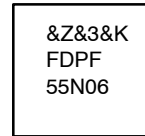
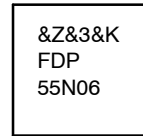

FDP55N06,
FDPF55N06 = Specific Device Code
&Z = Assembly Location
&3 = Date Code (Year and Week)
&K = Lot Code

ORDERING INFORMATION

Device	Package	Shipping
FDP55N06	TO-220	50 Units / Tube
FDPF55N06	TO-220F	50 Units / Tube

FDP55N06 / FDPF55N06

ABSOLUTE MAXIMUM RATINGS (T_C = 25°C unless otherwise noted)

Symbol	Parameter	FDP55N06	FDPF55N06	Unit
V _{DSS}	Drain to Source Voltage	60	60	V
I _D	Drain Current – – Continuous (T _C = 25°C) – Continuous (T _C = 100°C)	55 34.8	55* 34.8*	A
I _{DM}	Drain Current – Pulsed (Note 1)	220	220*	A
V _{GSS}	Gate–Source Voltage	±25	±25	V
E _{AS}	Single Pulsed Avalanche Energy (Note 2)	480	480	mJ
I _{AR}	Avalanche Current (Note 1)	55	55	A
E _{AR}	Repetitive Avalanche Energy (Note 1)	11.4	11.4	mJ
dv/dt	Peak Diode Recovery dv/dt (Note 3)	4.5	4.5	V/ns
P _D	Power Dissipation (T _C = 25°C) – Derate Above 25°C	114 0.9	48 0.4	W W/°C
T _J , T _{STG}	Operating and Storage Temperature Range	–55 to +150	–55 to +150	°C
T _L	Maximum Lead Temperature for Soldering, 1/8" from Case for 5 Second	300	300	°C

Stresses exceeding those listed in the Maximum Ratings table may damage the device. If any of these limits are exceeded, device functionality should not be assumed, damage may occur and reliability may be affected.

*Drain current limited by maximum junction temperature

1. Repetitive Rating: Pulse width limited by maximum junction temperature.
2. L = 5.6 mH, I_{AS} = 55 A, V_{DD} = 50 V, R_G = 25 Ω, Starting T_J = 25°C
3. I_{SD} ≤ 55 A, di/dt ≤ 200 A/μs, V_{DD} ≤ BV_{DSS}, Starting T_J = 25°C

THERMAL CHARACTERISTICS

Symbol	Parameter	FDP55N06	FDL100N50F	Unit
R _{θJC}	Thermal Resistance, Junction–to–Case, Max.	1.1	2.58	°C/W
R _{θJS}	Thermal Resistance, Junction–to–sink, Typ.	0.5	–	°C/W
R _{θJA}	Thermal Resistance, Junction–to–Ambient, Max.	62.5	62.5	°C/W

ELECTRICAL CHARACTERISTICS (T_J = 25°C unless otherwise noted)

Parameter	Symbol	Test Condition	Min	Typ	Max	Unit
-----------	--------	----------------	-----	-----	-----	------

OFF CHARACTERISTICS

BV _{DSS}	Drain–Source Breakdown Voltage	I _D = 250 μA, V _{GS} = 0 V	60	–	–	V
ΔBV _{DSS} / ΔT _J	Breakdown Voltage Temperature Coefficient	I _D = 250 μA, Referenced to 25°C	–	0.05	–	V/°C
I _{DSS}	Zero Gate Voltage Drain Current	V _{DS} = 60 V, V _{GS} = 0 V	–	–	1	μA
		V _{DS} = 48 V, T _C = 150°C	–	–	10	
I _{GSSF}	Gate–Body Leakage Current, Forward	V _{GS} = 20 V, V _{DS} = 0 V	–	–	100	nA
I _{GSSR}	Gate–Body Leakage Current, Reverse	V _{GS} = –20 V, V _{DS} = 0 V	–	–	–100	nA

ON CHARACTERISTICS

V _{GS(th)}	Gate Threshold Voltage	V _{DS} = V _{GS} , I _D = 250 μA	2.0	–	4.0	V
R _{DS(on)}	Static Drain–Source On Resistance	V _{GS} = 10 V, I _D = 27.5 A	–	0.018	0.022	Ω
g _{FS}	Forward Transconductance	V _{DS} = 25 V, I _D = 27.5 A	–	33	–	S

DYNAMIC CHARACTERISTICS

C _{iss}	Input Capacitance	V _{DS} = 25 V, V _{GS} = 0 V, f = 1 MHz	–	1160	1510	pF
C _{oss}	Output Capacitance		–	375	490	pF
C _{rss}	Reverse Transfer Capacitance		–	60	90	pF

FDP55N06 / FDPF55N06

ELECTRICAL CHARACTERISTICS ($T_J = 25^\circ\text{C}$ unless otherwise noted) (continued)

Parameter	Symbol	Test Condition	Min	Typ	Max	Unit
-----------	--------	----------------	-----	-----	-----	------

SWITCHING CHARACTERISTICS

$t_{d(on)}$	Turn-On Delay Time	$V_{DD} = 30\text{ V}$, $I_D = 55\text{ A}$, $R_G = 25\ \Omega$ (Note 4)	–	30	65	ns
t_r	Turn-On Rise Time		–	130	265	ns
$t_{d(off)}$	Turn-Off Delay Time		–	70	150	ns
t_f	Turn-Off Fall Time		–	95	195	ns
$Q_{g(tot)}$	Total Gate Charge at 10V	$V_{DD} = 48\text{ V}$, $I_D = 55\text{ A}$, $V_{GS} = 10\text{ V}$ (Note 4)	–	30	37	nC
Q_{GS}	Gate-Source Gate Charge		–	6.5	–	nC
Q_{gd}	Gate-Drain Charge		–	7.5	–	nC

DRAIN-SOURCE DIODE CHARACTERISTICS

I_S	Maximum Continuous Drain-Source Diode Forward Current		–	–	55	A
I_{SM}	Maximum Pulsed Drain to Source Diode Forward Current		–	–	220	A
V_{SD}	Drain to Source Diode Forward Voltage	$V_{GS} = 0\text{ V}$, $I_{SD} = 55\text{ A}$	–	–	1.4	V
t_{rr}	Reverse Recovery Time	$V_{GS} = 0\text{ V}$, $I_{SD} = 55\text{ A}$ $di_F/dt = 100\text{ A}/\mu\text{s}$	–	40	–	ns
Q_{rr}	Reverse Recovery Charge		–	55	–	μC

Product parametric performance is indicated in the Electrical Characteristics for the listed test conditions, unless otherwise noted. Product performance may not be indicated by the Electrical Characteristics if operated under different conditions.

4. Essentially independent of operating temperature.

TYPICAL CHARACTERISTICS

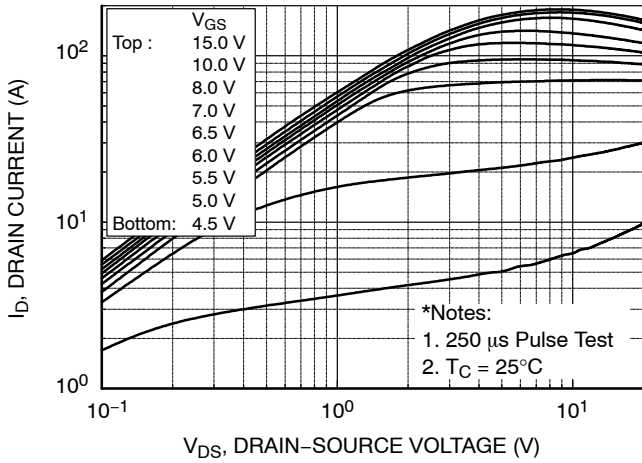

Figure 1. On-Region Characteristics

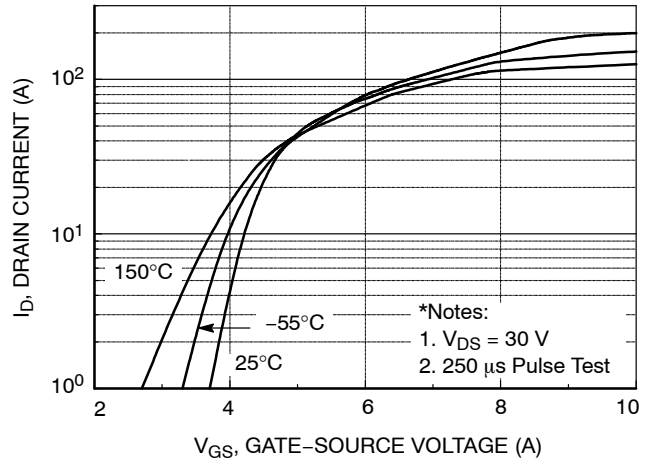

Figure 2. Transfer Characteristics

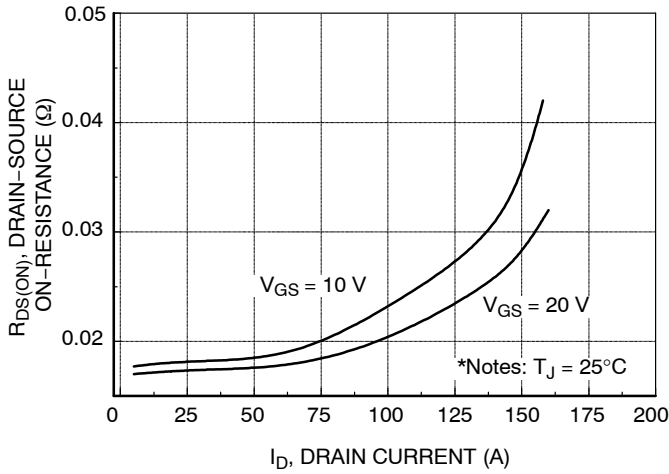

Figure 3. On-Resistance Variation vs. Drain Current and Gate Voltage

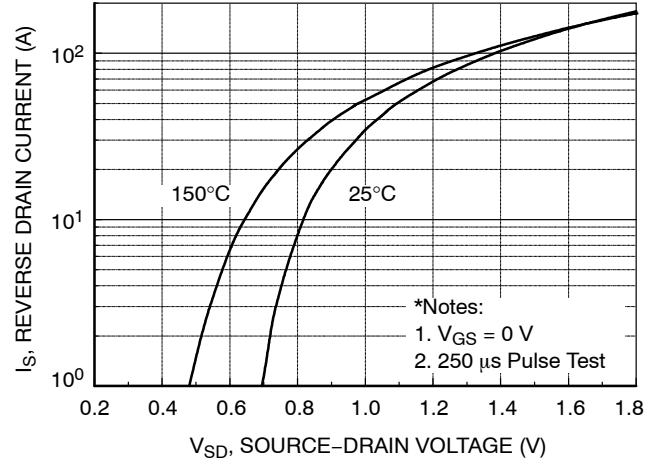

Figure 4. Body Diode Forward Voltage Variation vs. Source Current and Temperature

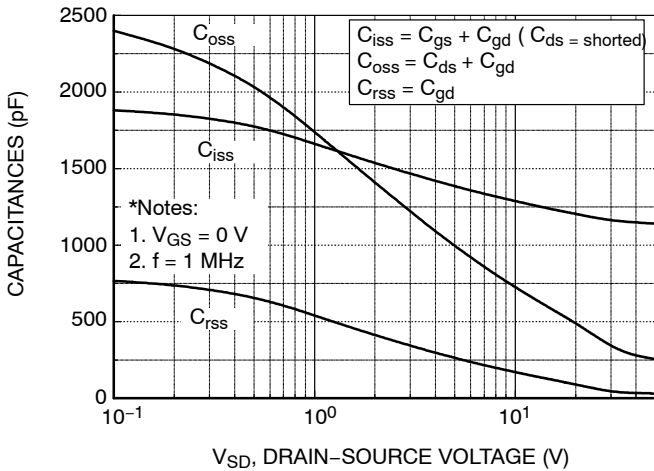

Figure 5. Capacitance Characteristics

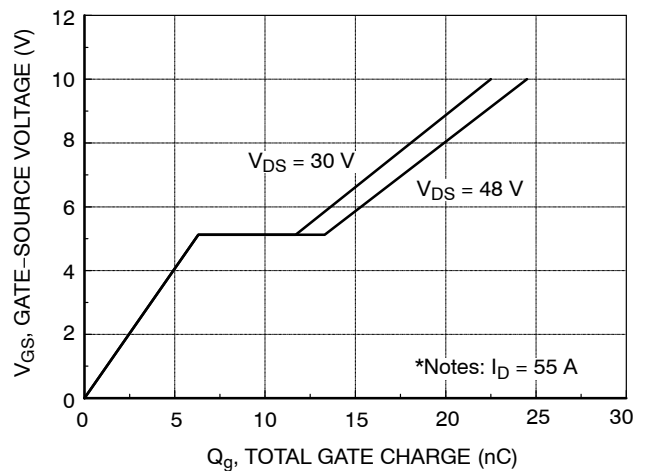

Figure 6. Gate Charge Characteristics

TYPICAL CHARACTERISTICS (continued)

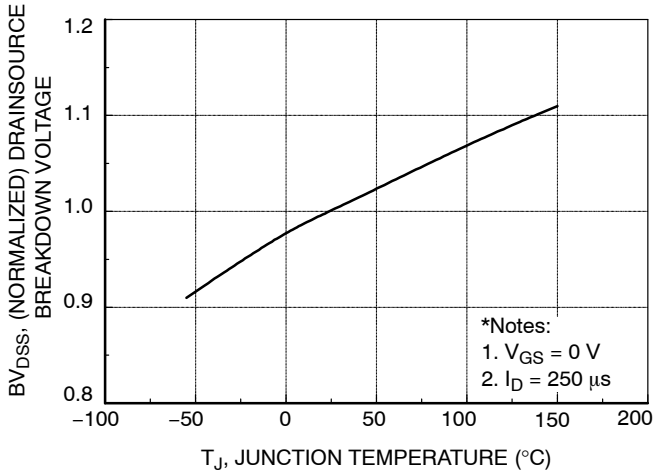

Figure 7. Breakdown Voltage Variation vs. Temperature

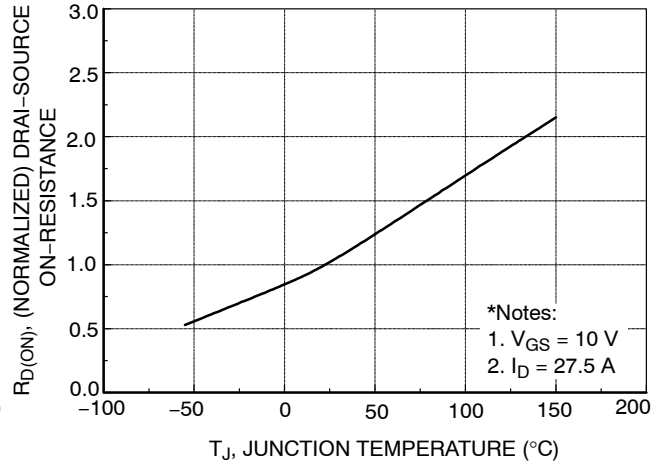

Figure 8. On-Resistance Variation vs. Temperature

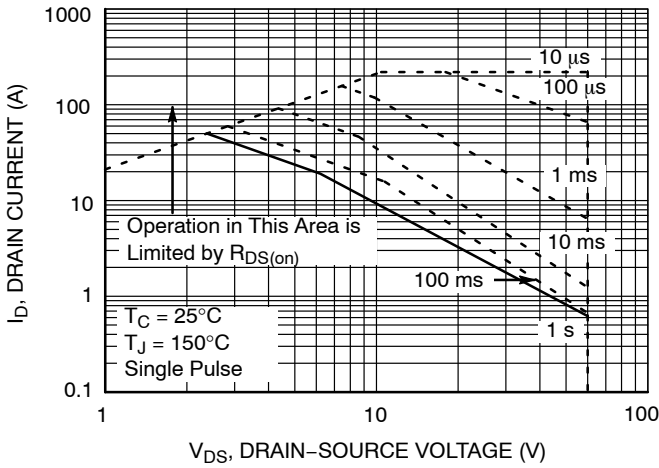

Figure 9-1. Maximum Safe Operating Area for FDP55N06

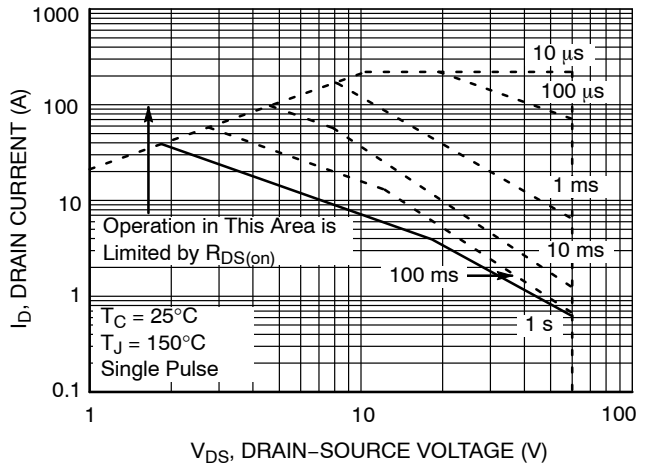

Figure 9-2. Maximum Safe Operating Area for FDPF55N06

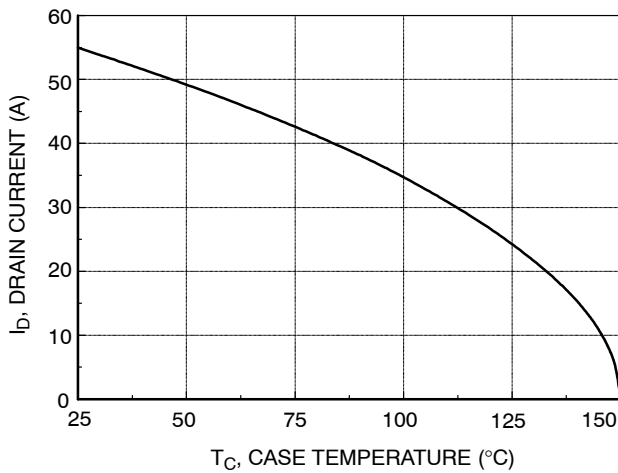

Figure 10. Maximum Drain Current vs. Case Temperature

FDP55N06 / FDPF55N06

TYPICAL PERFORMANCE CHARACTERISTICS (CONTINUED)

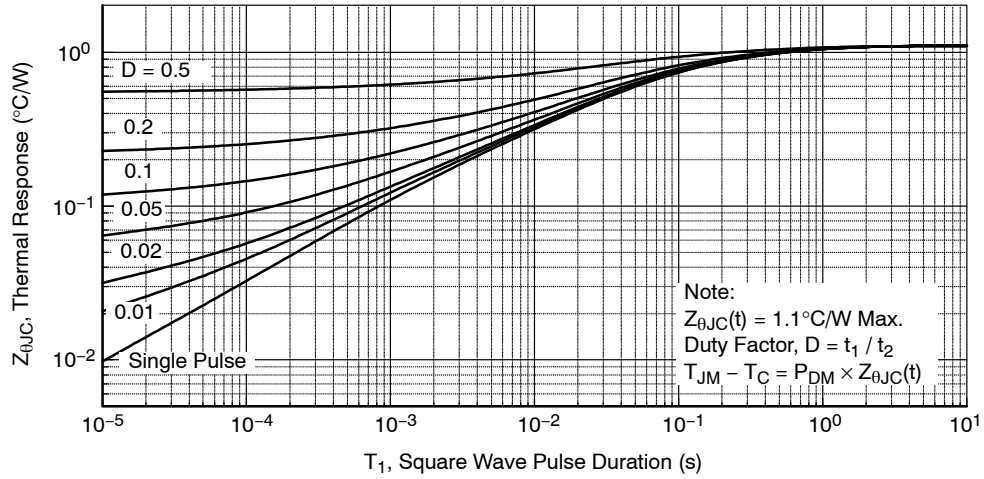

Figure 11-1. Transient Thermal Response Curve for FDP55N06

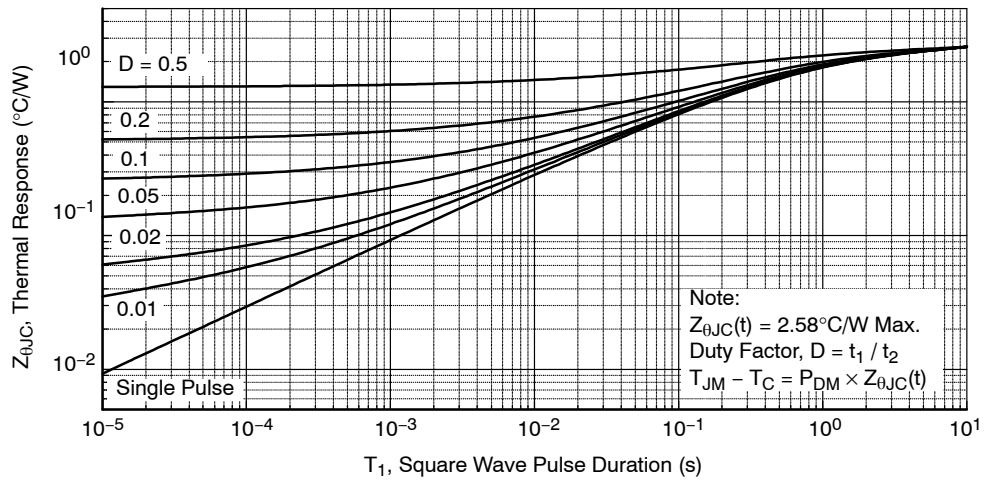

Figure 11-2. Transient Thermal Response Curve for FDPF55N06

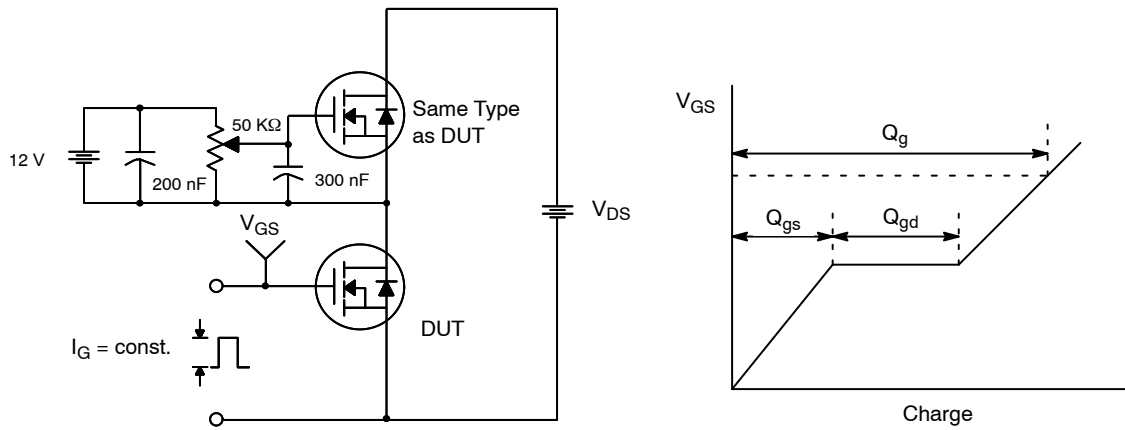

Figure 12. Gate Charge Test Circuit & Waveform

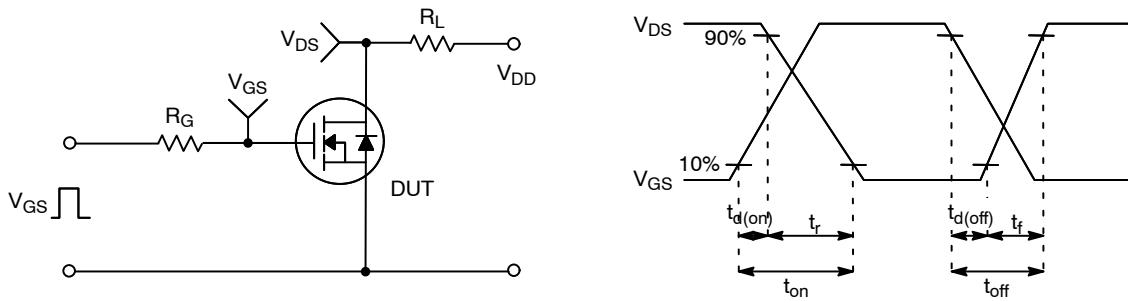

Figure 13. Resistive Switching Test Circuit & Waveforms

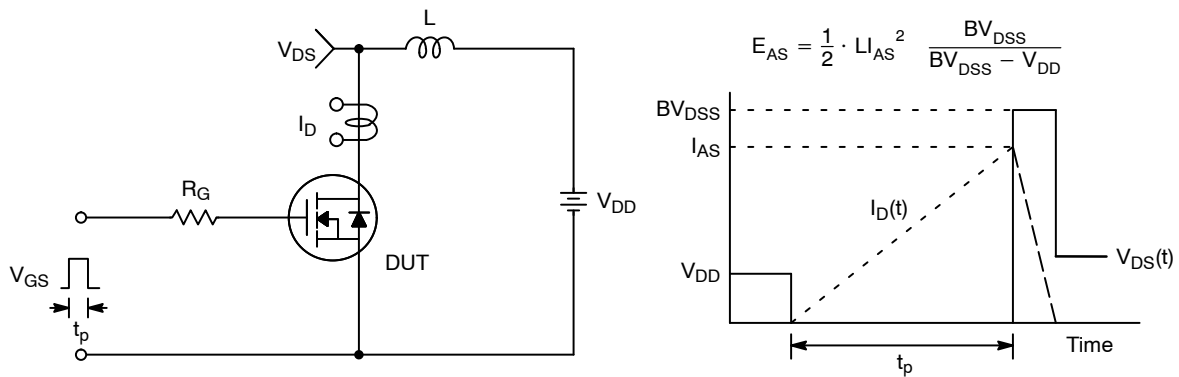

Figure 14. Unclamped Inductive Switching Test Circuit & Waveforms

FDP55N06 / FDPF55N06

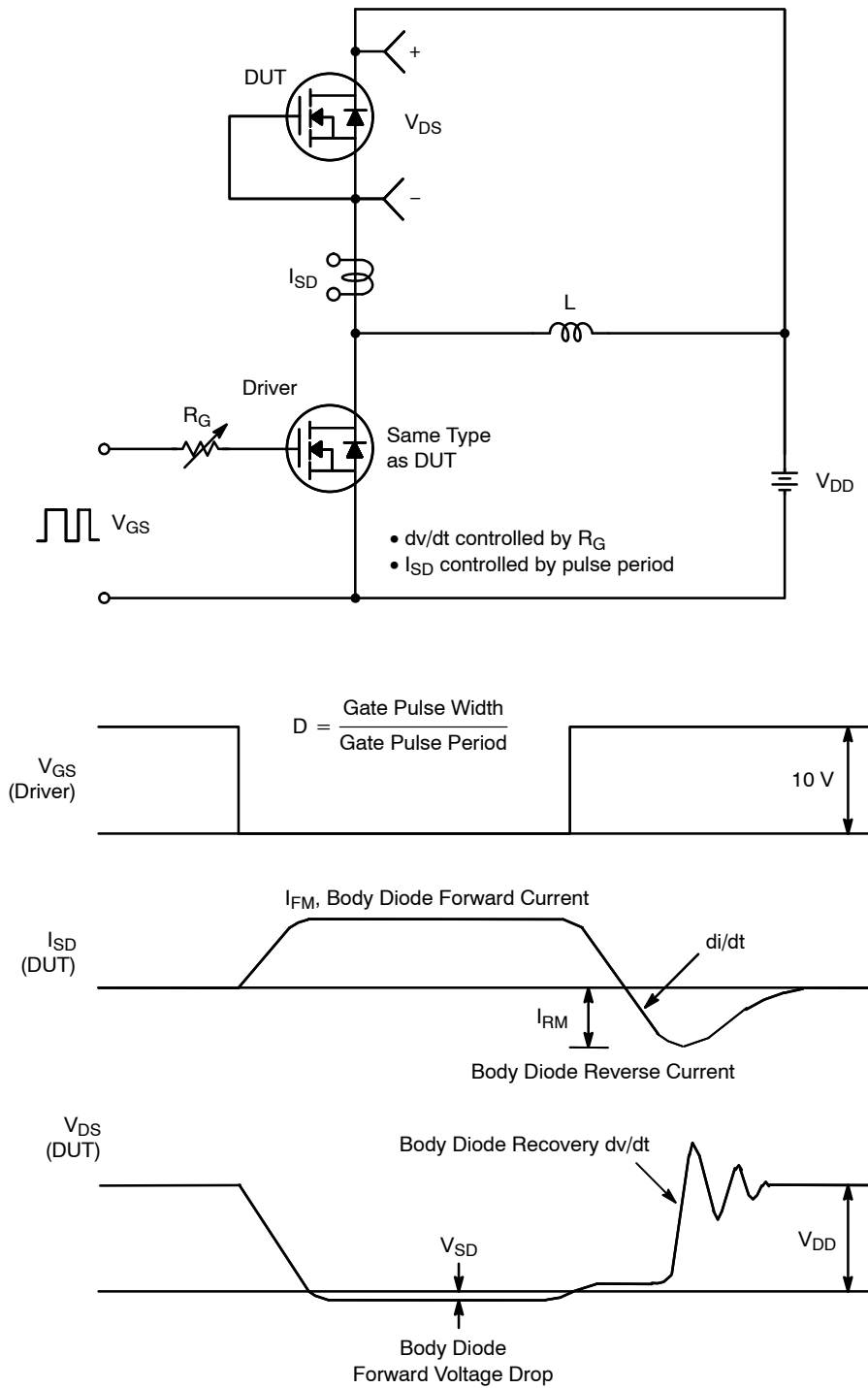

Figure 15. Peak Recovery dv/dt Test Circuit & Waveforms

MECHANICAL CASE OUTLINE

PACKAGE DIMENSIONS

ON Semiconductor®



TO-220 Fullpack, 3-Lead / TO-220F-3SG
CASE 221AT
ISSUE B

DATE 19 JAN 2021

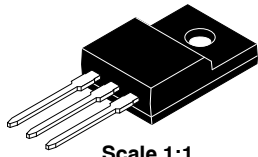

Scale 1:1

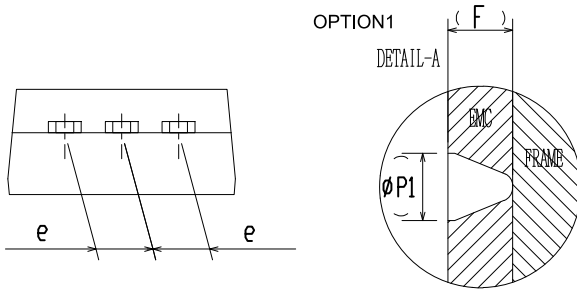
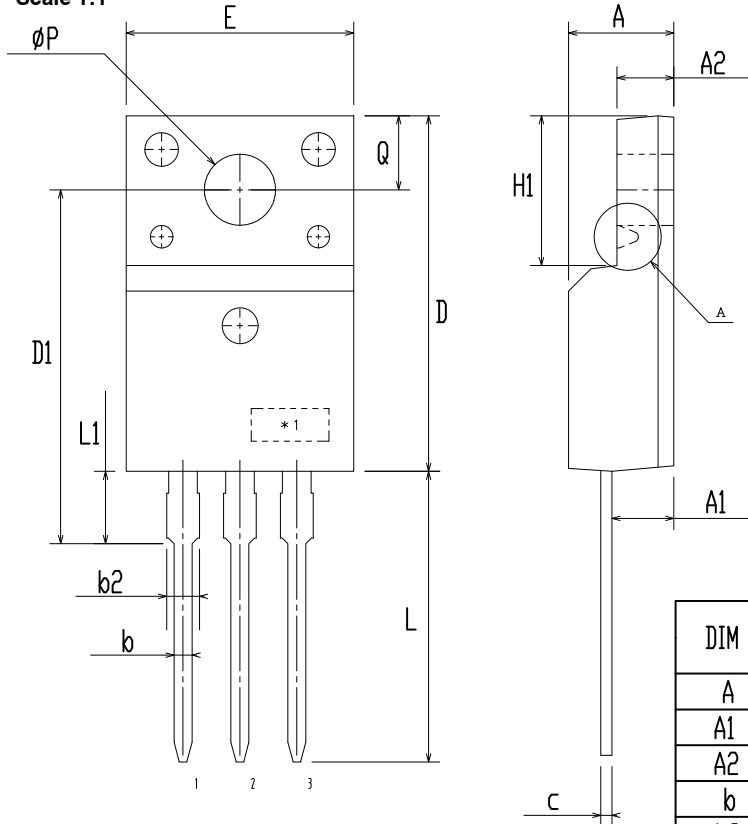

DIM	MILLIMETERS		
	MIN	NOM	MAX
A	4.50	4.70	4.90
A1	2.56	2.76	2.96
A2	2.34	2.54	2.74
b	0.70	0.80	0.90
b2	~	~	1.47
c	0.45	0.50	0.60
D	15.67	15.87	16.07
D1	15.60	15.80	16.00
E	9.96	10.16	10.36
e	2.34	2.54	2.74
F	~	0.84	~
H1	6.48	6.68	6.88
L	12.78	12.98	13.18
L1	3.03	3.23	3.43
phi P	2.98	3.18	3.38
phi P1	~	1.00	~
Q	3.20	3.30	3.40

NOTES:

- A. DIMENSION AND TOLERANCE AS ASME Y14.5-2009
- B. DIMENSIONS ARE EXCLUSIVE OF BURRS, MOLD FLASH AND TIE BAR PROTRUCTIONS.
- C. OPTION 1 - WITH SUPPORT PIN HOLE
- OPTION 2 - NO SUPPORT PIN HOLE

DOCUMENT NUMBER:	98AON67439E	Electronic versions are uncontrolled except when accessed directly from the Document Repository. Printed versions are uncontrolled except when stamped "CONTROLLED COPY" in red.
DESCRIPTION:	TO-220 FULLPACK, 3-LEAD / TO-220F-3SG	PAGE 1 OF 1

ON Semiconductor and are trademarks of Semiconductor Components Industries, LLC dba ON Semiconductor or its subsidiaries in the United States and/or other countries. ON Semiconductor reserves the right to make changes without further notice to any products herein. ON Semiconductor makes no warranty, representation or guarantee regarding the suitability of its products for any particular purpose, nor does ON Semiconductor assume any liability arising out of the application or use of any product or circuit, and specifically disclaims any and all liability, including without limitation special, consequential or incidental damages. ON Semiconductor does not convey any license under its patent rights nor the rights of others.

MECHANICAL CASE OUTLINE

PACKAGE DIMENSIONS

ON Semiconductor®

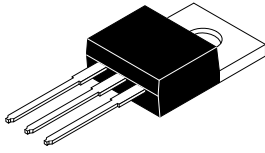

Scale 1:1

TO-220-3LD CASE 340AT ISSUE A

DATE 03 OCT 2017

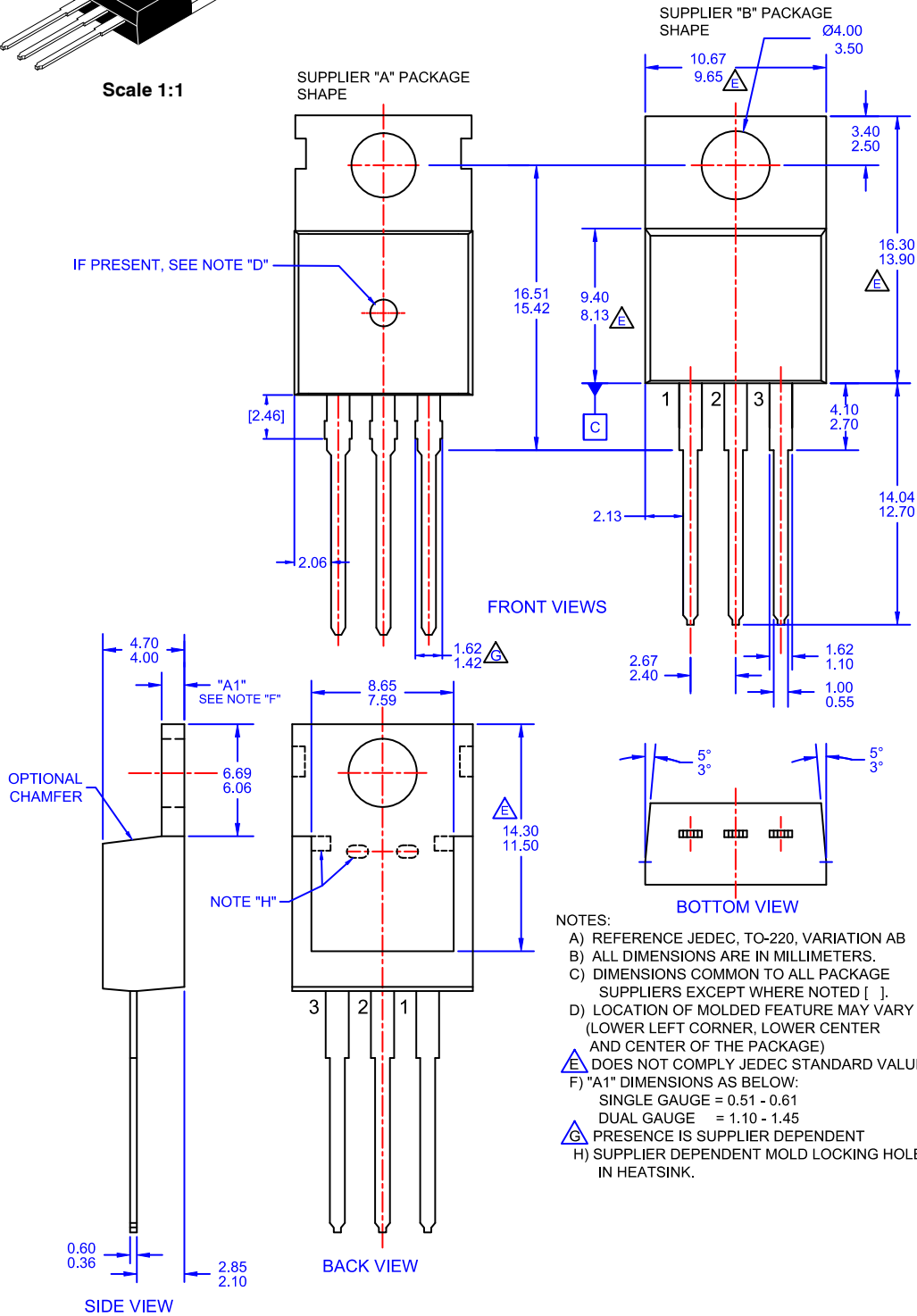

NOTES:

- A) REFERENCE JEDEC, TO-220, VARIATION AB
- B) ALL DIMENSIONS ARE IN MILLIMETERS.
- C) DIMENSIONS COMMON TO ALL PACKAGE SUPPLIERS EXCEPT WHERE NOTED [].
- D) LOCATION OF MOLDED FEATURE MAY VARY (LOWER LEFT CORNER, LOWER CENTER AND CENTER OF THE PACKAGE)
- E) DOES NOT COMPLY JEDEC STANDARD VALUE.
- F) "A1" DIMENSIONS AS BELOW:
 SINGLE GAUGE = 0.51 - 0.61
 DUAL GAUGE = 1.10 - 1.45
- G) PRESENCE IS SUPPLIER DEPENDENT
- H) SUPPLIER DEPENDENT MOLD LOCKING HOLES IN HEATSINK.

DOCUMENT NUMBER:	98AON13818G	Electronic versions are uncontrolled except when accessed directly from the Document Repository. Printed versions are uncontrolled except when stamped "CONTROLLED COPY" in red.
DESCRIPTION:	TO-220-3LD	PAGE 1 OF 1

ON Semiconductor and are trademarks of Semiconductor Components Industries, LLC dba ON Semiconductor or its subsidiaries in the United States and/or other countries. ON Semiconductor reserves the right to make changes without further notice to any products herein. ON Semiconductor makes no warranty, representation or guarantee regarding the suitability of its products for any particular purpose, nor does ON Semiconductor assume any liability arising out of the application or use of any product or circuit, and specifically disclaims any and all liability, including without limitation special, consequential or incidental damages. ON Semiconductor does not convey any license under its patent rights nor the rights of others.

onsemi, **Onsemi**, and other names, marks, and brands are registered and/or common law trademarks of Semiconductor Components Industries, LLC dba "**onsemi**" or its affiliates and/or subsidiaries in the United States and/or other countries. **onsemi** owns the rights to a number of patents, trademarks, copyrights, trade secrets, and other intellectual property. A listing of **onsemi**'s product/patent coverage may be accessed at www.onsemi.com/site/pdf/Patent-Marking.pdf. **onsemi** reserves the right to make changes at any time to any products or information herein, without notice. The information herein is provided "as-is" and **onsemi** makes no warranty, representation or guarantee regarding the accuracy of the information, product features, availability, functionality, or suitability of its products for any particular purpose, nor does **onsemi** assume any liability arising out of the application or use of any product or circuit, and specifically disclaims any and all liability, including without limitation special, consequential or incidental damages. Buyer is responsible for its products and applications using **onsemi** products, including compliance with all laws, regulations and safety requirements or standards, regardless of any support or applications information provided by **onsemi**. "Typical" parameters which may be provided in **onsemi** data sheets and/or specifications can and do vary in different applications and actual performance may vary over time. All operating parameters, including "Typicals" must be validated for each customer application by customer's technical experts. **onsemi** does not convey any license under any of its intellectual property rights nor the rights of others. **onsemi** products are not designed, intended, or authorized for use as a critical component in life support systems or any FDA Class 3 medical devices or medical devices with a same or similar classification in a foreign jurisdiction or any devices intended for implantation in the human body. Should Buyer purchase or use **onsemi** products for any such unintended or unauthorized application, Buyer shall indemnify and hold **onsemi** and its officers, employees, subsidiaries, affiliates, and distributors harmless against all claims, costs, damages, and expenses, and reasonable attorney fees arising out of, directly or indirectly, any claim of personal injury or death associated with such unintended or unauthorized use, even if such claim alleges that **onsemi** was negligent regarding the design or manufacture of the part. **onsemi** is an Equal Opportunity/Affirmative Action Employer. This literature is subject to all applicable copyright laws and is not for resale in any manner.

ADDITIONAL INFORMATION

TECHNICAL PUBLICATIONS:

Technical Library: www.onsemi.com/design/resources/technical-documentation
onsemi Website: www.onsemi.com

ONLINE SUPPORT: www.onsemi.com/support

For additional information, please contact your local Sales Representative at www.onsemi.com/support/sales