

FDR8308P

Dual P-Channel, Logic Level, PowerTrench™ MOSFET

General Description

The SuperSOT-8 family of P-Channel Logic Level MOSFETs have been designed to provide a low profile, small footprint alternative to industry standard SO-8 little foot type product.

These P-Channel Logic Level MOSFETs are produced using Fairchild Semiconductor's advanced PowerTrench process that has been tailored to minimize the on-state resistance and yet maintain superior switching performance.

These devices are well suited for portable electronics applications: load switching and power management, battery charging circuits, and DC/DC conversion.

Features

- -3.2 A, -20 V. $R_{DS(ON)} = 0.050 \Omega @ V_{GS} = -4.5 V$,
 $R_{DS(ON)} = 0.070 \Omega @ V_{GS} = -2.5 V$.
- Low gate charge (13nC typical).
- High performance trench technology for extremely low $R_{DS(ON)}$.
- SuperSOT™-8 package: small footprint (40% less than SO-8); low profile(1mmthick); maximum power comparable to SO-8.

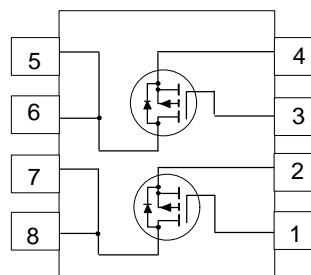
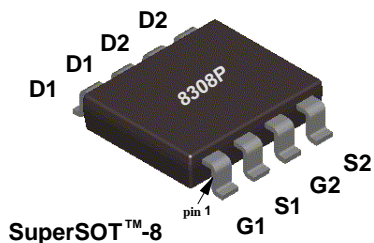

Absolute Maximum Ratings $T_A = 25^\circ\text{C}$ unless otherwise noted

| Symbol | Parameter | FDR8308P | Units |
|----------------|---|------------|------------------|
| V_{DSS} | Drain-Source Voltage | -20 | V |
| V_{GSS} | Gate-Source Voltage | ± 8 | V |
| I_D | Drain Current - Continuous (Note 1) | -3.2 | A |
| | - Pulsed | -20 | |
| P_D | Maximum Power Dissipation (Note 1) | 0.8 | W |
| T_J, T_{STG} | Operating and Storage Temperature Range | -55 to 150 | $^\circ\text{C}$ |

THERMAL CHARACTERISTICS

| | | | |
|-----------------|--|-----|--------------------|
| $R_{\theta JA}$ | Thermal Resistance, Junction-to-Ambient (Note 1) | 156 | $^\circ\text{C/W}$ |
| $R_{\theta JC}$ | Thermal Resistance, Junction-to-Case (Note 1) | 40 | $^\circ\text{C/W}$ |

Electrical Characteristics (T_A = 25°C unless otherwise noted)

| Symbol | Parameter | Conditions | Min | Typ | Max | Units |
|---|---|--|------|-------|-------|-------|
| OFF CHARACTERISTICS | | | | | | |
| BV _{DSS} | Drain-Source Breakdown Voltage | V _{GS} = 0 V, I _D = -250 μA | -20 | | | V |
| ΔBV _{DSS} /ΔT _J | Breakdown Voltage Temp. Coefficient | I _D = -50 μA, Referenced to 25 °C | | -16 | | mV/°C |
| I _{DSS} | Zero Gate Voltage Drain Current | V _{DS} = -16 V, V _{GS} = 0 V | | | -1 | μA |
| | | T _J = 55°C | | | -10 | μA |
| I _{GSS} | Gate - Body Leakage Current | V _{GS} = 8 V, V _{DS} = 0 V | | | 100 | nA |
| I _{GSS} | Gate - Body Leakage, Reverse | V _{GS} = -8 V, V _{DS} = 0 V | | | -100 | nA |
| ON CHARACTERISTICS (Note 2) | | | | | | |
| V _{GS(th)} | Gate Threshold Voltage | V _{DS} = V _{GS} , I _D = -250 μA | -0.4 | -0.9 | -1.5 | V |
| ΔV _{GS(th)} /ΔT _J | Gate Threshold Voltage Temp. Coefficient | I _D = -50 μA, Referenced to 25 °C | | 2.5 | | mV/°C |
| R _{DS(on)} | Static Drain-Source On-Resistance | V _{GS} = -4.5 V, I _D = -3.2 A | | 0.038 | 0.05 | Ω |
| | | T _J = 125°C | | 0.053 | 0.075 | |
| | | V _{GS} = -2.5 V, I _D = -2.7 A | | 0.054 | 0.07 | |
| I _{D(on)} | On-State Drain Current | V _{GS} = -4.5 V, V _{DS} = -5 V | -20 | | | A |
| g _{FS} | Forward Transconductance | V _{DS} = -4.5 V, I _D = -3.2 A | | 13 | | S |
| DYNAMIC CHARACTERISTICS | | | | | | |
| C _{iss} | Input Capacitance | V _{DS} = -10 V, V _{GS} = 0 V, f = 1.0 MHz | | 1240 | | pF |
| C _{oss} | Output Capacitance | | | 270 | | pF |
| C _{rss} | Reverse Transfer Capacitance | | | 100 | | pF |
| SWITCHING CHARACTERISTICS (Note 2) | | | | | | |
| t _{D(on)} | Turn - On Delay Time | V _{DD} = -5 V, I _D = -1 A, V _{GS} = -4.5 V, R _{GEN} = 6 Ω | | 8 | 16 | ns |
| t _r | Turn - On Rise Time | | | 15 | 27 | ns |
| t _{D(off)} | Turn - Off Delay Time | | | 45 | 65 | ns |
| t _f | Turn - Off Fall Time | | | 30 | 50 | ns |
| Q _g | Total Gate Charge | V _{DS} = -10 V, I _D = -4.5 A, V _{GS} = -4.5 V | | 13 | 19 | nC |
| Q _{gs} | Gate-Source Charge | | | 1.8 | | nC |
| Q _{gd} | Gate-Drain Charge | | | 3 | | nC |
| DRAIN-SOURCE DIODE CHARACTERISTICS AND MAXIMUM RATINGS | | | | | | |
| I _S | Maximum Continuous Drain-Source Diode Forward Current | | | | -0.67 | A |
| V _{SD} | Drain-Source Diode Forward Voltage | V _{GS} = 0 V, I _S = -0.67 A (Note 2) | | -0.7 | -1.2 | V |

Notes:

- R_{θJA} is the sum of the junction-to-case and case-to-ambient thermal resistance where the case thermal reference is defined as the solder mounting surface of the drain pins. R_{θJC} is guaranteed by design while R_{θCA} is determined by the user's board design.



156°C/W on a 0.0025 in² pad of 2oz copper.



Scale 1 : 1 on letter size paper

- Pulse Test: Pulse Width ≤ 300μs, Duty Cycle ≤ 2.0%.

Typical Electrical Characteristics

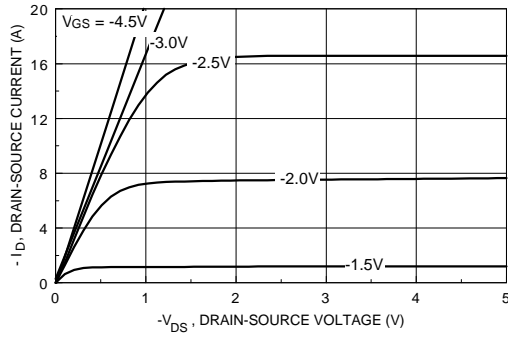

Figure 1. On-Region Characteristics.

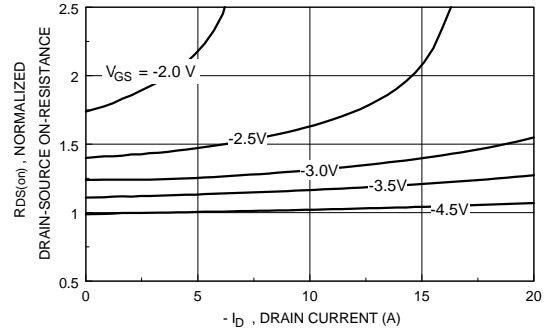

Figure 2. On-Resistance Variation with Drain Current and Gate Voltage.

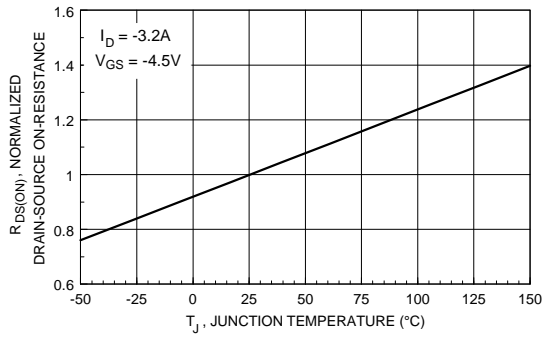

Figure 3. On-Resistance Variation with Temperature.

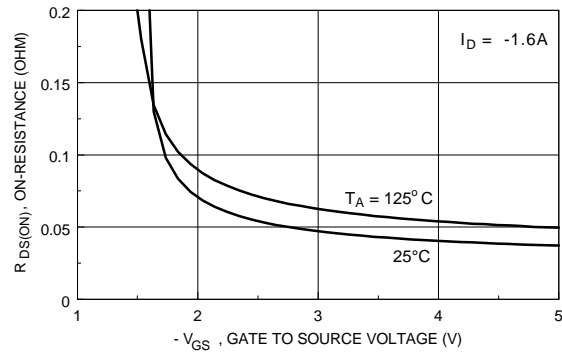

Figure 4. On-Resistance Variation with Gate-to-Source Voltage.

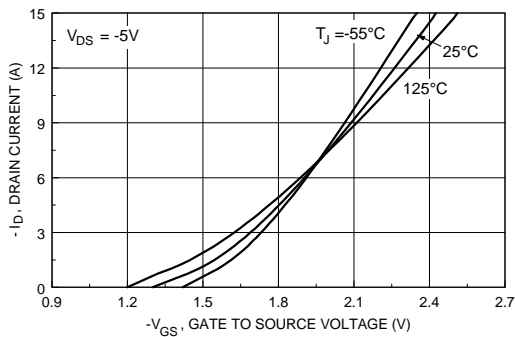

Figure 5. Transfer Characteristics.

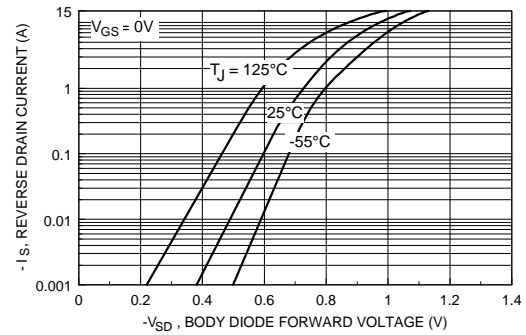

Figure 6. Body Diode Forward Voltage Variation with Source Current and Temperature.

Typical Electrical Characteristics (continued)

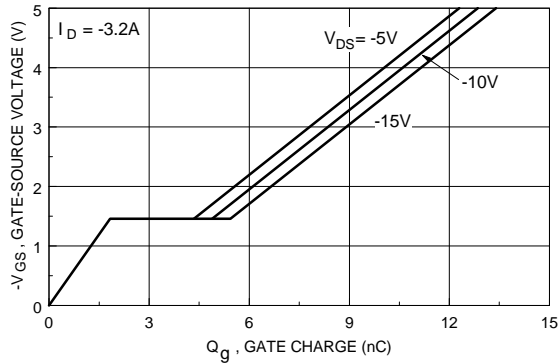

Figure 7. Gate Charge Characteristics.

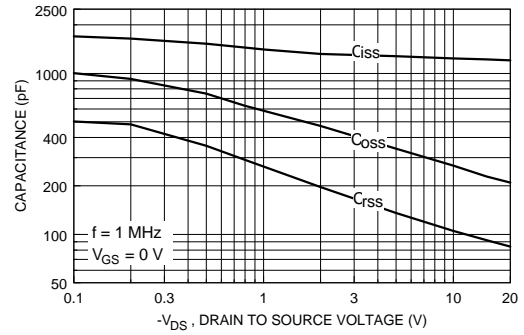

Figure 8. Capacitance Characteristics.

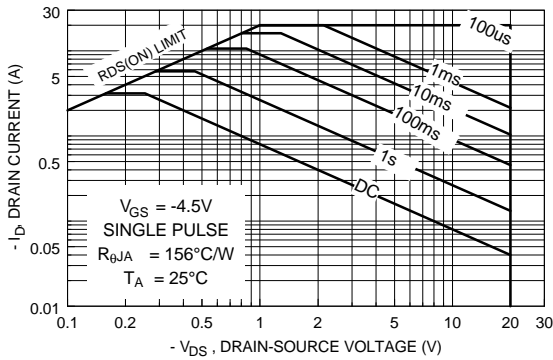

Figure 9. Maximum Safe Operating Area.

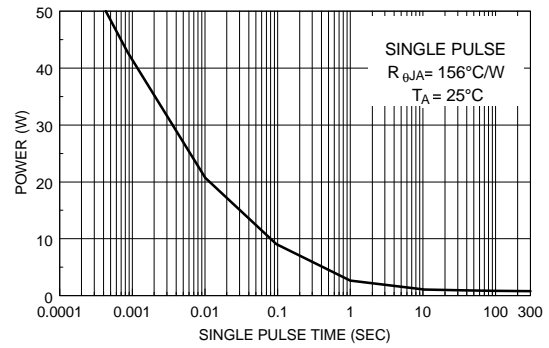

Figure 10. Single Pulse Maximum Power Dissipation.

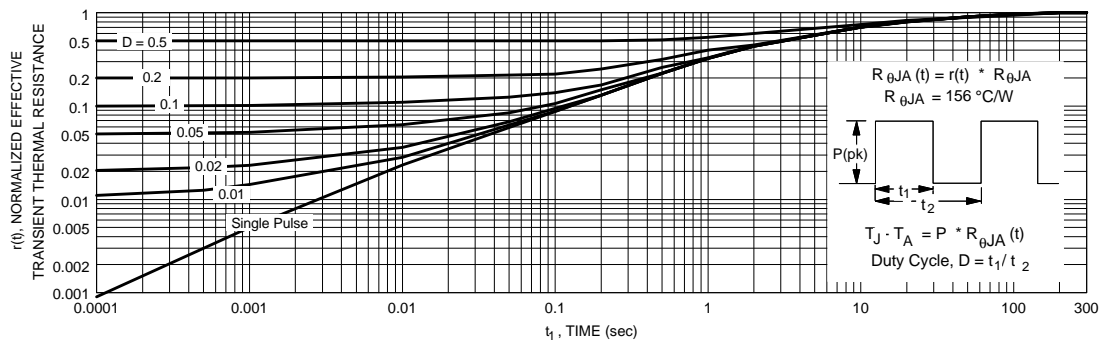

Figure 11. Transient Thermal Response Curve.

Thermal characterization performed using the conditions described in note 1.
Transient thermal response will change depending on the circuit board design.

SuperSOT™-8 Tape and Reel Data and Package Dimensions



SSOT-8 Packaging Configuration: Figure 1.0

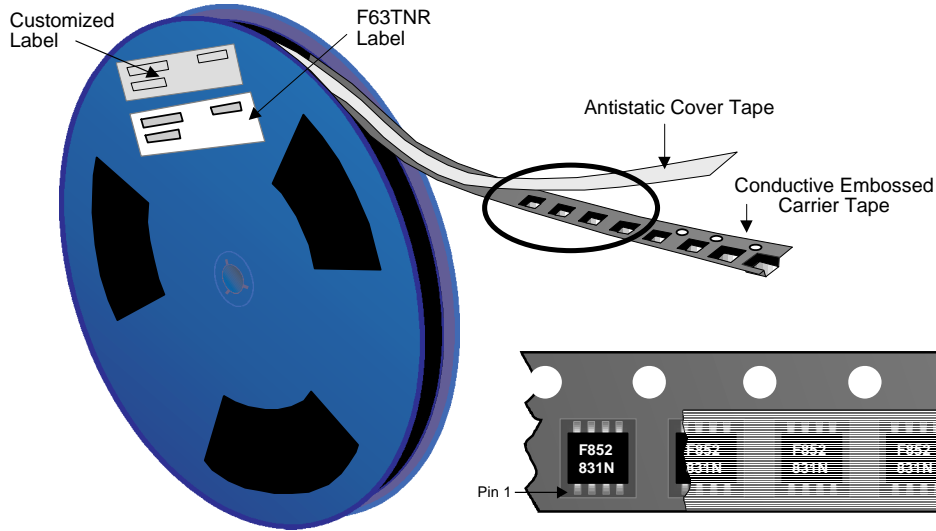

| SSOT-8 Packaging Information | | |
|------------------------------|-------------------------|------------|
| Packaging Option | Standard (no flow code) | L84Z |
| Packaging type | TNR | TNR |
| Qty per Reel/Tube/Bag | 3,000 | 500 |
| Reel Size | 13" Dia | 7" Dia |
| Box Dimension (mm) | 343x64x343 | 184x187x47 |
| Max qty per Box | 5,000 | 1,000 |
| Weight per unit (gm) | 0.0416 | 0.0416 |
| Weight per Reel (kg) | 0.5615 | 0.0980 |
| Note/Comments | | |

SSOT-8 Unit Orientation

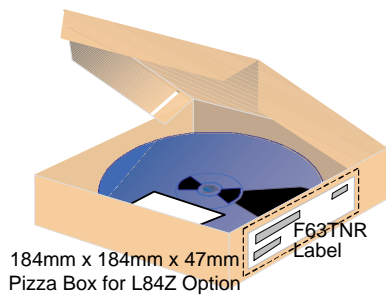
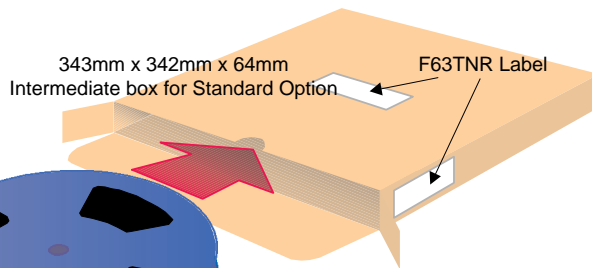

F63TNR Label sample



SSOT-8 Tape Leader and Trailer Configuration: Figure 2.0

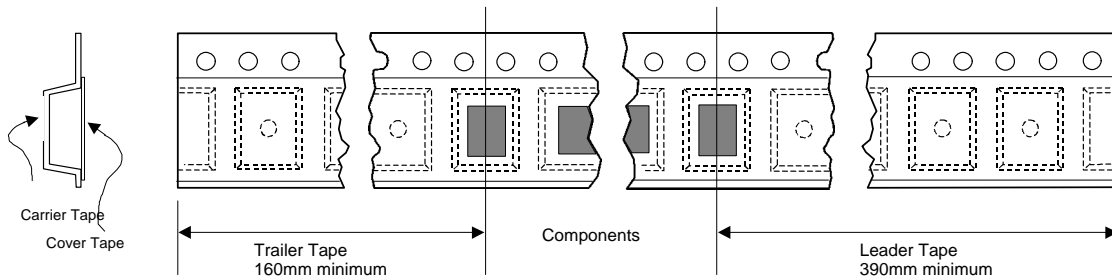

SuperSOT™-8 Tape and Reel Data and Package Dimensions, continued

SSOT-8 Embossed Carrier Tape Configuration: Figure 3.0

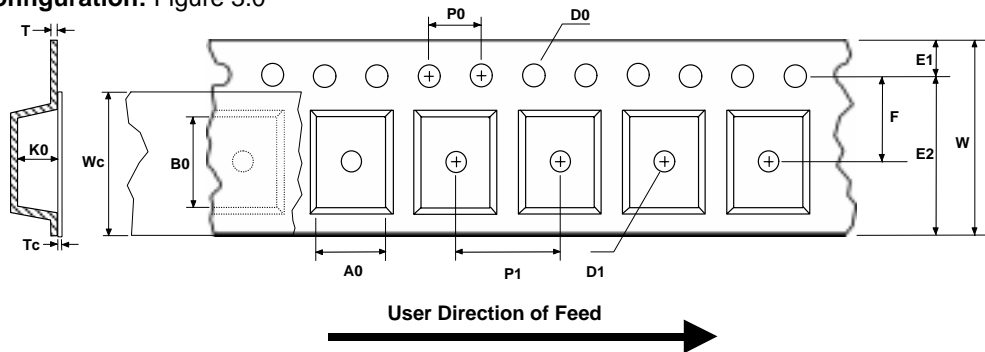

| Dimensions are in millimeter | | | | | | | | | | | | | | |
|------------------------------|-----------------|-----------------|----------------|-----------------|-----------------|-----------------|--------------|-----------------|---------------|---------------|-----------------|-------------------|-----------------|-----------------|
| Pkg type | A0 | B0 | W | D0 | D1 | E1 | E2 | F | P1 | P0 | K0 | T | Wc | Tc |
| SSOT-8 (12mm) | 4.47 +/-0.10 | 5.00 +/-0.10 | 12.0 +/-0.3 | 1.55 +/-0.05 | 1.50 +/-0.10 | 1.75 +/-0.10 | 10.25 min | 5.50 +/-0.05 | 8.0 +/-0.1 | 4.0 +/-0.1 | 1.37 +/-0.10 | 0.280 +/-0.150 | 9.5 +/-0.025 | 0.06 +/-0.02 |

Notes: A0, B0, and K0 dimensions are determined with respect to the EIA/Jedec RS-481 rotational and lateral movement requirements (see sketches A, B, and C).

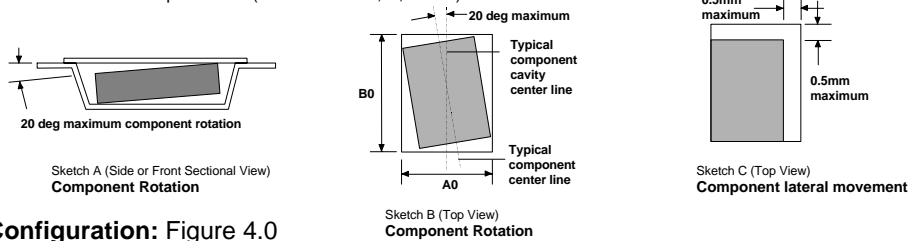

SSOT-8 Reel Configuration: Figure 4.0

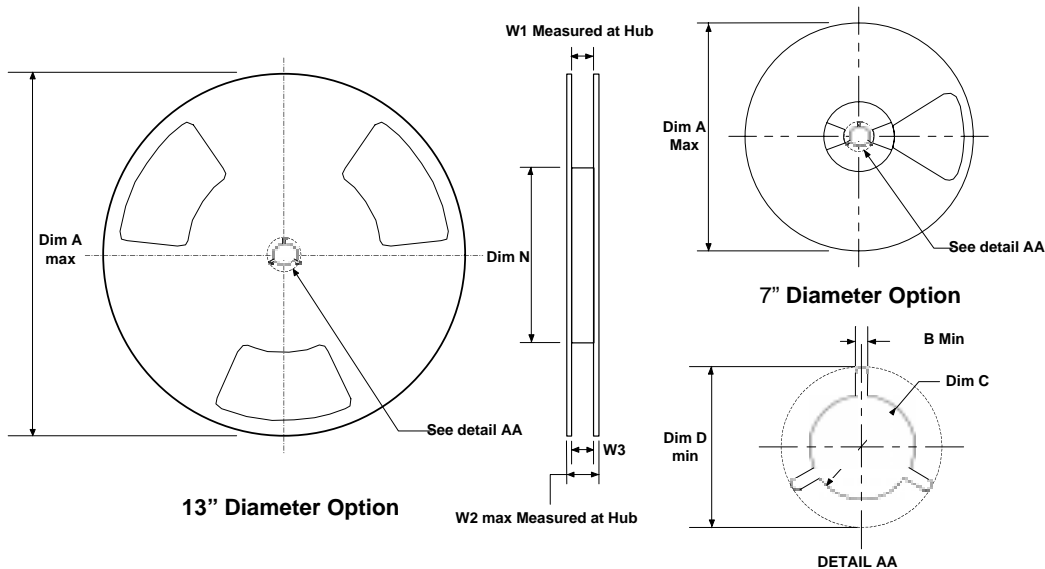

| Dimensions are in inches and millimeters | | | | | | | | | |
|--|-------------|---------------|--------------|-----------------------------------|---------------|--------------|----------------------------------|---------------|------------------------------|
| Tape Size | Reel Option | Dim A | Dim B | Dim C | Dim D | Dim N | Dim W1 | Dim W2 | Dim W3 (LSL-USL) |
| 12mm | 7" Dia | 7.00 177.8 | 0.059 1.5 | 512 +0.020/-0.008 13 +0.5/-0.2 | 0.795 20.2 | 5.906 150 | 0.488 +0.078/-0.000 12.4 +2/0 | 0.724 18.4 | 0.469 - 0.606 11.9 - 15.4 |
| 12mm | 13" Dia | 13.00 330 | 0.059 1.5 | 512 +0.020/-0.008 13 +0.5/-0.2 | 0.795 20.2 | 7.00 178 | 0.488 +0.078/-0.000 12.4 +2/0 | 0.724 18.4 | 0.469 - 0.606 11.9 - 15.4 |

SuperSOT™-8 Tape and Reel Data and Package Dimensions, continued

SuperSOT™-8 (FS PKG Code 34, 35)

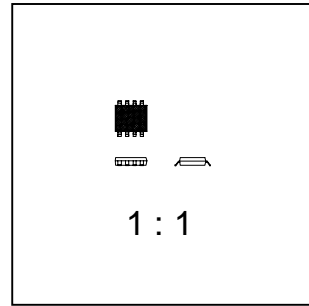
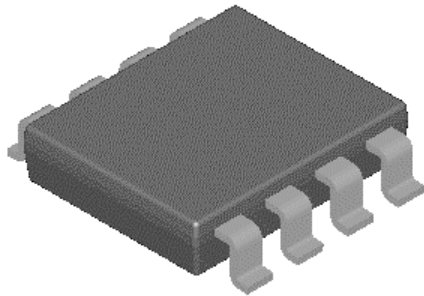

Scale 1:1 on letter size paper

Dimensions shown below are in:
inches [millimeters]

Part Weight per unit (gram): 0.0416

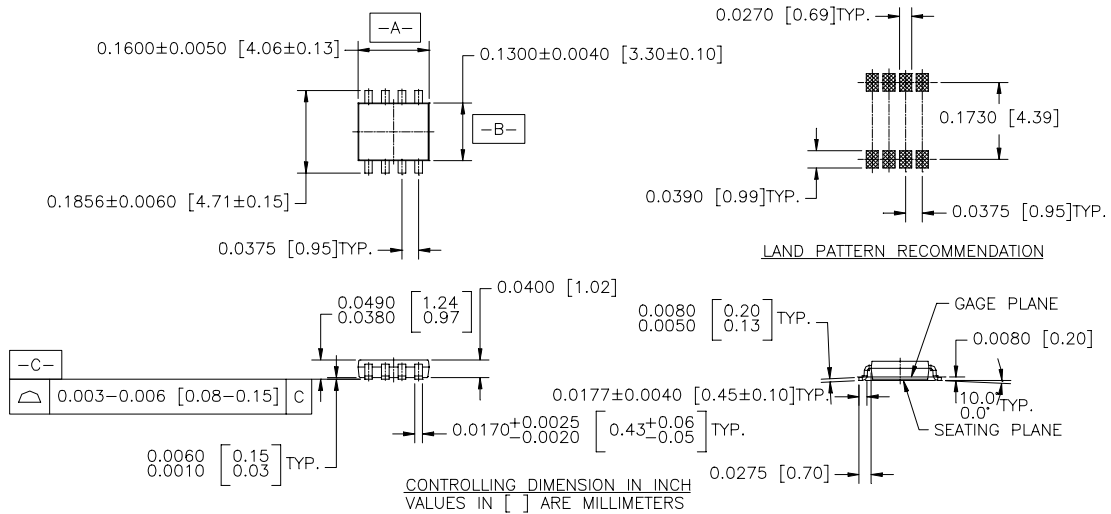

NOTES : UNLESS OTHERWISE SPECIFIED

- STANDARD LEAD FINISH TO BE 200 MICRONS / 5.08 MICROMETERS MINIMUM TIN/LEAD (SOLDER) ON COPPER.
- NO JEDEC REGISTRATION AS JAN. 1996

SUPER SOT, 8 LEADS

TRADEMARKS

The following are registered and unregistered trademarks Fairchild Semiconductor owns or is authorized to use and is not intended to be an exhaustive list of all such trademarks.

| | |
|----------------------|---------------|
| ACEx™ | ISOPLANAR™ |
| CoolFET™ | MICROWIRE™ |
| CROSSVOLT™ | POP™ |
| E ² CMOS™ | PowerTrench™ |
| FACT™ | QS™ |
| FACT Quiet Series™ | Quiet Series™ |
| FAST® | SuperSOT™-3 |
| FASTr™ | SuperSOT™-6 |
| GTO™ | SuperSOT™-8 |
| HiSeC™ | TinyLogic™ |

DISCLAIMER

FAIRCHILD SEMICONDUCTOR RESERVES THE RIGHT TO MAKE CHANGES WITHOUT FURTHER NOTICE TO ANY PRODUCTS HEREIN TO IMPROVE RELIABILITY, FUNCTION OR DESIGN. FAIRCHILD DOES NOT ASSUME ANY LIABILITY ARISING OUT OF THE APPLICATION OR USE OF ANY PRODUCT OR CIRCUIT DESCRIBED HEREIN; NEITHER DOES IT CONVEY ANY LICENSE UNDER ITS PATENT RIGHTS, NOR THE RIGHTS OF OTHERS.

LIFE SUPPORT POLICY

FAIRCHILD'S PRODUCTS ARE NOT AUTHORIZED FOR USE AS CRITICAL COMPONENTS IN LIFE SUPPORT DEVICES OR SYSTEMS WITHOUT THE EXPRESS WRITTEN APPROVAL OF FAIRCHILD SEMICONDUCTOR CORPORATION. As used herein:

1. Life support devices or systems are devices or systems which, (a) are intended for surgical implant into the body, or (b) support or sustain life, or (c) whose failure to perform when properly used in accordance with instructions for use provided in the labeling, can be reasonably expected to result in significant injury to the user.
2. A critical component is any component of a life support device or system whose failure to perform can be reasonably expected to cause the failure of the life support device or system, or to affect its safety or effectiveness.

PRODUCT STATUS DEFINITIONS

Definition of Terms

| Datasheet Identification | Product Status | Definition |
|--------------------------|------------------------|---|
| Advance Information | Formative or In Design | This datasheet contains the design specifications for product development. Specifications may change in any manner without notice. |
| Preliminary | First Production | This datasheet contains preliminary data, and supplementary data will be published at a later date. Fairchild Semiconductor reserves the right to make changes at any time without notice in order to improve design. |
| No Identification Needed | Full Production | This datasheet contains final specifications. Fairchild Semiconductor reserves the right to make changes at any time without notice in order to improve design. |
| Obsolete | Not In Production | This datasheet contains specifications on a product that has been discontinued by Fairchild semiconductor. The datasheet is printed for reference information only. |