

# **OLYMPUS<sup>®</sup>**

DIGITAL CAMERA

# **FE-110/X-705** **FE-100/X-710**

ENGLISH 2

FRANÇAIS 30

ESPAÑOL 58

PORTUGUÊS 86

## **Basic Manual**

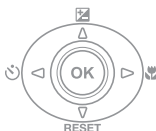
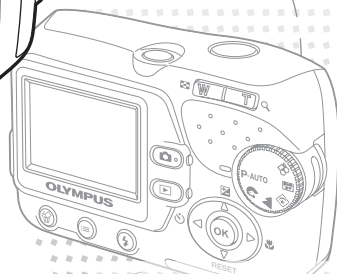
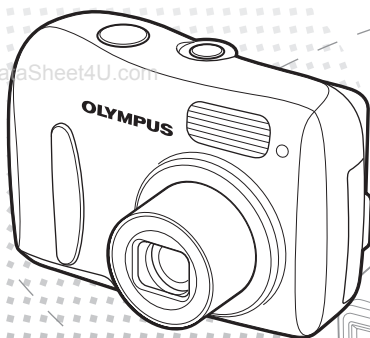

[www.DataSheet4U.com](http://www.DataSheet4U.com)

# Table of Contents

<b>CAMERA DIAGRAM .....</b>	<b>3</b>
<b>BEFORE YOU BEGIN .....</b>	<b>4</b>
<b>GETTING STARTED .....</b>	<b>5</b>
Step 1 GETTING STARTED .....	5
Step 2 TAKE A PICTURE .....	6
Step 3 REVIEW OR ERASE A PICTURE .....	7
Step 4 TRANSFER IMAGES .....	8
<b>BASIC OPERATION .....</b>	<b>10</b>
Shooting Tips .....	10
Shooting Button and Playback Button .....	10
Shooting Mode Buttons .....	11
Shooting Mode .....	12
Self-Timer .....	12
Exposure Compensation Mode .....	13
Macro Mode .....	13
Flash Modes .....	14
Power Save Feature .....	14
<b>MENUS AND SETTINGS .....</b>	<b>15</b>
Menu .....	15
Erase All Pictures .....	15
Select a Language .....	16
Monitor Symbols & Icons .....	17
Thumbnail (Index) Display .....	18
<b>CONNECTING THE CAMERA .....</b>	<b>19</b>
Playback on a TV .....	19
Direct Printing (PictBridge) .....	20
<b>OLYMPUS Master SOFTWARE .....</b>	<b>21</b>
<b>SPECIFICATIONS .....</b>	<b>22</b>
<b>SAFETY PRECAUTIONS .....</b>	<b>24</b>

- Before using your camera, read this manual carefully to ensure correct use.
- We recommend that you take test shots to get accustomed to your camera before taking important photographs.
- Please observe the safety precautions at the end of this manual.
- The images of the LCD screen and illustrations of the camera used in this manual may differ from the actual product. For this manual, all of the images are based on the FE-110/X-705 model.

# CAMERA DIAGRAM

Strap Eyelet

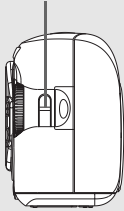

Shutter Button

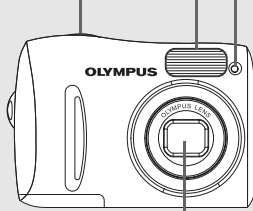

Lens

Flash

Self-Timer Lamp

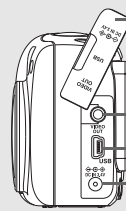

Connector Cover

VIDEO OUT Jack

USB Connector

DC-IN Jack

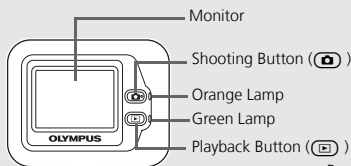

Monitor

Shooting Button (  )

Orange Lamp

Green Lamp

Playback Button (  )

Power Switch

Zoom Button

Mode Dial

OK Button (  )

Arrow Pad (  )

Erase Button (  )

Menu Button (  )

Flash Mode Button (  )

Lock Button

Tripod Socket

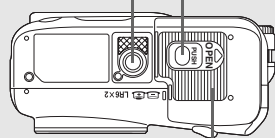

Battery Compartment/  
Card Cover

En

## BEFORE YOU BEGIN

### Gather these items (box contents)



Digital Camera



Strap

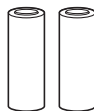

AA (R6) Batteries (two)

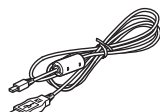

USB Cable (light gray)

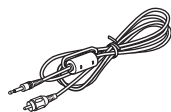

Video Cable (black)



OLYMPUS Master software CD-ROM

Items not shown: Advanced Manual (CD-ROM), Basic Manual (This manual), Warranty card. Contents may vary depending on purchase location.

An xD-Picture Card is included with the FE-110/X-705 model only.



[www.DataSheet4U.com](http://www.DataSheet4U.com)

### Tips

- The camera you have purchased comes with its own internal memory. Even when an xD-Picture Card is not inserted, your pictures will be saved on the internal memory.

[www.DataSheet4U.com](http://www.DataSheet4U.com)

# 1 GETTING STARTED

## a. Attach the strap

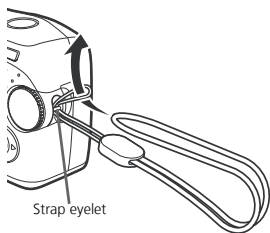

- Pull the strap tight so that it does not come loose.

## b. Insert the batteries

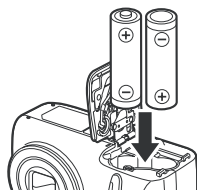
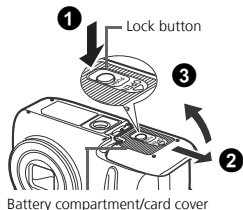

## c. Set the date and time

www.DataSheet4U.com

- 1 Turn the mode dial to **P-AUTO** and press the power switch to turn the camera on.
- 2 Press to display the menu screen.

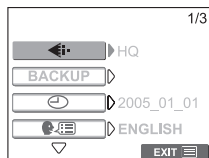

- 3 Press to set an item. Press to select the next field.

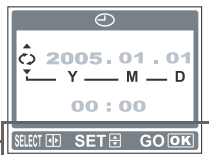

Operation guide

www.DataSheet4U.com

En

# 2 TAKE A PICTURE

En

## a. Zoom

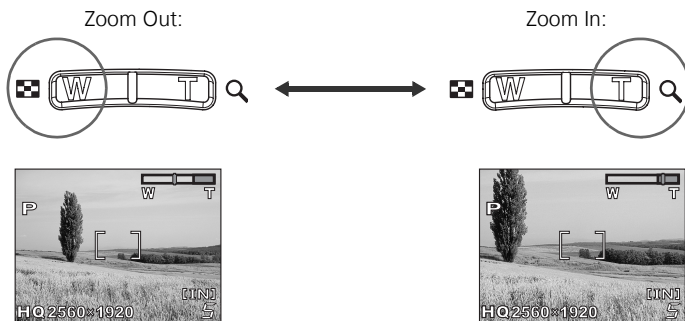

## b. Focus

- 1 Using the monitor, place the AF target mark over your subject.

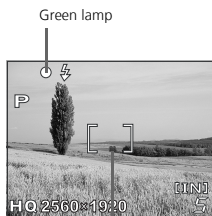

(Pressed Halfway)

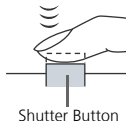

- 2 Press and hold the shutter button halfway to lock the focus.
  - The green lamp indicates the focus is locked.

## c. Take the picture

- 1 Press the shutter button completely to take the picture.

(Pressed Completely)

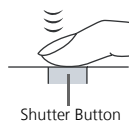

www.DataSheet4U.com

# 3 REVIEW OR ERASE A PICTURE



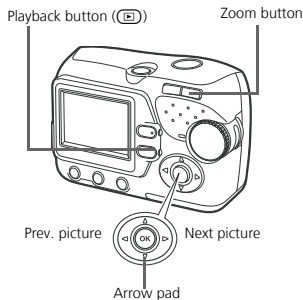

## a. Press

- The last picture taken will be displayed.



## b. Take a closer look



- Press T () to enlarge the image.
- Press W () to return to normal.
- Press  or  to scroll around.



Press  to return to shooting mode.

En

www.DataSheet4U.com

## c. To erase a picture

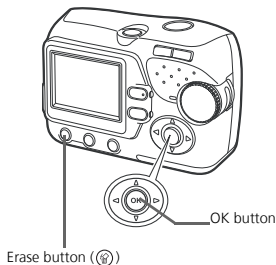

- 1 Display the picture you want to erase.
- 2 Press .
- 3 Select [YES], and press .
  - The picture is permanently erased.

www.DataSheet4U.com

# 4 TRANSFER IMAGES

## a. Install the software

- 1 Insert the OLYMPUS Master CD-ROM.
- 2 **Windows:** Click the "OLYMPUS Master" button.  
**Macintosh:** Double-click the "Installer" icon.
- 3 Simply follow the on-screen instructions.

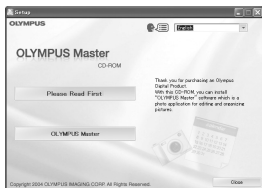

En

## b. Connect the camera to the computer

- 1 Connect the camera and computer using the USB cable (included).
  - The monitor will turn on automatically.

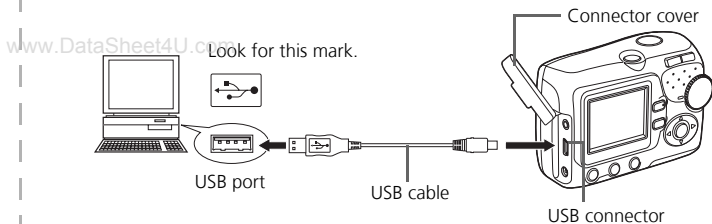

- 2 Select [PC] on the monitor, and press **OK**.

- Your PC will now recognize your camera as a removable storage drive.

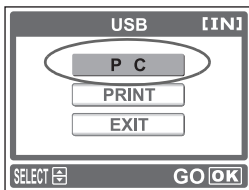



## c. Transfer images to the computer

- 1 With the camera now connected, open OLYMPUS Master.
  - The [Transfer Images] window is displayed.
- 2 Select the images you want to transfer, and click the [Transfer Images] button.

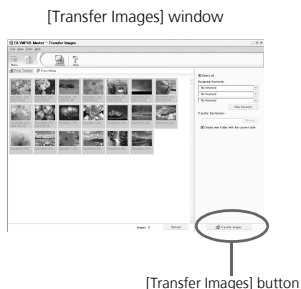

If the [Transfer Images] window is not displayed automatically:

- a. Click the "Transfer Images" icon on the OLYMPUS Master main menu.
- b. Click the "From Camera" icon.



[www.DataSheet4U.com](http://www.DataSheet4U.com)

### Tips

- For more detailed information regarding camera setup and usage, please refer to the camera's "Advanced Manual" provided on CD-ROM.
- For information on how to use other features of OLYMPUS Master software not mentioned above, open "Help" in the OLYMPUS Master software, or read the reference manual (PDF format).

[www.DataSheet4U.com](http://www.DataSheet4U.com)

# BASIC OPERATION

## Shooting Tips

Pictures may appear blurred as the result of moving the camera while the shutter button is being pressed.

To prevent the camera from moving, hold the camera firmly with both hands while keeping your elbows at your sides. Keep your fingers and the strap away from the lens and flash.

En

Horizontal grip

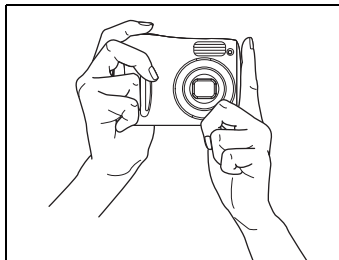

Vertical grip

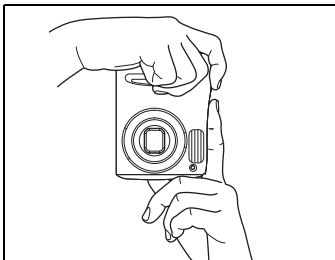

## Shooting Button and Playback Button

When taking pictures or making shooting settings, select shooting mode by pressing .

When displaying, editing or deleting pictures you have taken, select playback mode by pressing .

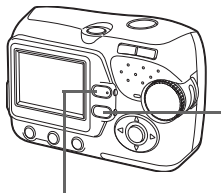

 button (Shooting mode)

 button (Playback mode)

## Shooting Mode Buttons

While in shooting mode, use these buttons for quick access to some of the more commonly used features.

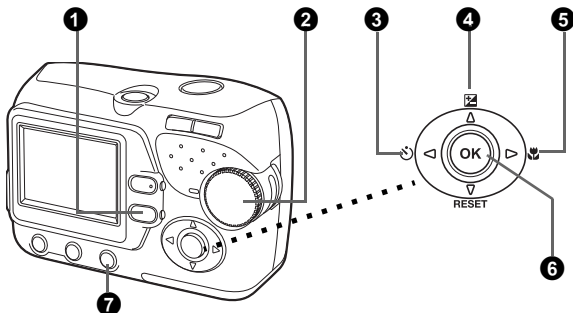

En

**1**  **button (Playback Mode)**

The camera switches to playback mode.

**2** **Mode dial**

In addition to the default (**P-AUTO**) mode, there are other modes that have optimal settings for their purpose and shooting conditions.

**3**  **button (Self-timer)**

Select the self-timer to delay the shot approximately 12 seconds from when the shutter button is pressed.

**4**  **button (Exposure Compensation)**

Use this setting to overexpose (+) or underexpose (-) a picture.

**5**  **button (Macro Mode)**

Use macro or super macro mode when taking close-up pictures such as of a flower.

**6**  **button**

Press to confirm settings.

**7**  **button (Flash Mode)**

Select from 4 flash modes - Auto, , , or  (Flash off).

## Shooting Mode

Turn the mode dial to select a shooting mode. As you turn the mode dial, the description for each mode is displayed on the monitor.

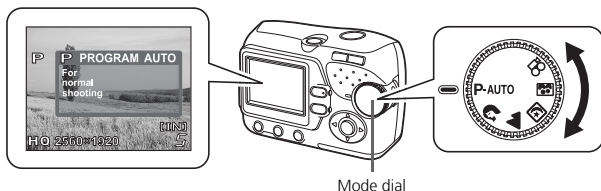

Mode dial

En

- **P-AUTO** PROGRAM AUTO
- PORTRAIT
- LANDSCAPE
- NIGHT SCENE
- SELF PORTRAIT
- MOVIE

## Self-Timer

- 1 Press .
  - The self-timer settings screen is displayed.
- 2 Press to select [ON], and press .
- 3 Press the shutter button fully to take the picture.
  - The self-timer lamp lights for approximately 10 seconds after the shutter button is pressed, then starts blinking. After blinking for approximately 2 seconds, the picture is taken.

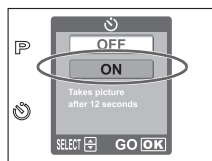

Self-timer lamp

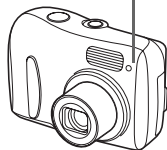

## Exposure Compensation Mode

- 1 Press  $\Delta$  (P).
  - The setting screen for the exposure compensation is displayed.
- 2 Press  $\triangleleft \triangleright$  to select the exposure compensation value, and press  $\odot$ .
  - Select a [ + ] value to brighten the image or a [ - ] value to darken the image.
- 3 Take the picture.

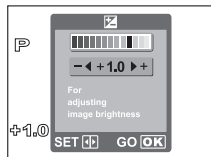



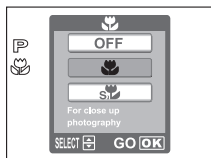

En

## Macro Mode

- 1 This mode lets you take pictures as close as 20 cm/8 in. to your subject (When the zoom is set to the widest setting).
  - 2 Use this mode to take pictures as close as 2 cm/0.8 in. to your subject. The position of the zoom is fixed automatically and cannot be changed.
- 1 Press  $\triangleright$  ().
    - The setting screen for the macro shooting is displayed.
  - 2 Press  $\Delta \nabla$  to select macro mode, and press  $\odot$ .
    - You can also set by pressing  $\triangleright$  () repeatedly.
  - 3 Take the picture.



## Flash Modes

- Press flash mode button (  ).
  - Flash setting screen is displayed.
- Press  to select the flash mode, and press .
  - You can also set by pressing  repeatedly.
- Press the shutter button halfway.
  - In conditions where the flash will fire,  lights (flash standby).
- Press the shutter button completely to take the picture.

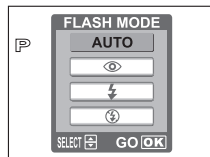



En

### Flash working range:



W (max.): Approx. 0.2 m to 3.8 m (0.7 ft. to 12.5 ft.)

T (max.): Approx. 0.5 m to 2.2 m (1.6 ft. to 7.2 ft.)

Icon	Flash Mode	Description
No indication	Auto flash	The flash fires automatically in low light or backlight conditions.
	Red-eye reduction flash	The red-eye reduction flash mode significantly reduces this phenomenon by emitting pre-flashes before firing the regular flash.
	Fill-in flash	The flash fires regardless of the available light.
	Flash off	The flash does not fire even in low light conditions.

www.DataSheet4U.com



## Power Save Feature

- To save battery power, the camera automatically enters to the sleep mode and stops operating if not used for 30 seconds. The monitor switches off automatically. Press the shutter button,  or  to turn the monitor on. You can select the length of time after which the camera automatically enters to the sleep mode.
- If the camera is not operated for 30 minutes after the camera enters sleep mode, it automatically retracts the lens and turns off. To resume operation, turn on the power again.

www.DataSheet4U.com

# MENUS AND SETTINGS

## Menu

- 1 Press  to display the camera's menu on the monitor.
- 2 Use the arrow pad and  to navigate and select menu items.

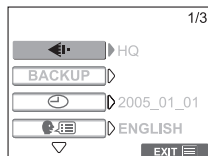



## Erase All Pictures

- 1 In the playback mode, select [MEMORY SETUP]\* from the menu, and press .  
\*When a card is inserted into the camera, [CARD SETUP] is displayed.

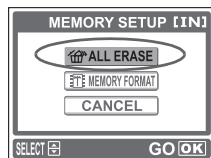
- 2 Press  to select [ ALL ERASE], and press .



[www.DataSheet4U.com](http://www.DataSheet4U.com)

- 3 Press  to select [YES], and press .
  - All the pictures are erased.



[www.DataSheet4U.com](http://www.DataSheet4U.com)



## Select a Language

You can select a language for on-screen display. Available languages vary depending on the area where you purchased this camera.

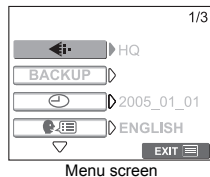
- 1 Press .
  - The menu screen is displayed.



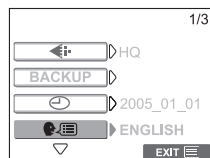

En

- 2 Press  to select .
- The selected item is displayed in yellow.



- 3 Press  or .

- 4 Press  to select a language, and press .



[www.DataSheet4U.com](http://www.DataSheet4U.com)

[www.DataSheet4U.com](http://www.DataSheet4U.com)



## Monitor Symbols & Icons

### ● Monitor - Shooting Mode



Still picture

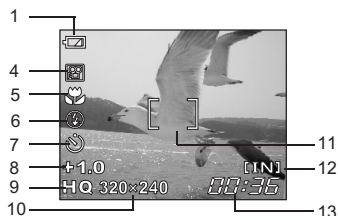

Movie

En

	Items	Indications
1	Battery check	=full power, =low power
2	Green lamp	A $\delta$ =Auto Focus Lock
3	Flash standby Camera movement warning/ Flash charge	(Lit) (Blinks)
4	Shooting mode	P, , , , ,
5	Macro mode Super macro mode	 S $\delta$
6	Flash mode	, ,
7	Self-timer	
8	Exposure compensation	-2.0 – +2.0
9	Record mode	SHQ, HQ, SQ1, SQ2
10	Image size	<ul style="list-style-type: none"> <li>•FE-110/X-705 2560x1920, 1600x1200, 640x480, 320x240, 160x120</li> <li>•FE-100/X-710 2272x1704, 1600x1200, 640x480, 320x240, 160x120</li> </ul>
11	AF target mark	[ ]
12	Current memory	[IN] (internal memory), [xD] (card)
13	Number of storable still pictures Remaining recording time	5 00:36

## ● Monitor - Playback mode



Still picture



Movie

	Items	Indications
1	Battery check	=full power, =low power
2	Current memory	[IN] (internal memory), [xD] (card)
3	Print reservation/Number of prints	x10
4	File number	100-0018
5	Protect	
6	Record mode	SHQ, HQ, SQ1, SQ2
7	Image size	<ul style="list-style-type: none"> <li>•FE-110/X-705 2560×1920, 1600×1200, 640×480, 320×240, 160×120</li> <li>•FE-100/X-710 2272×1704, 1600×1200, 640×480, 320×240, 160×120</li> </ul>
8	Exposure compensation	-2.0 – +2.0
9	Date and time	'05.10.10 12:30
10	Number of frames Elapsed time/total recording time (movie)	18 00:00/00:15
11	Movie	

## Thumbnail (Index) Display

This function lets you show several pictures at the same time on the monitor when you reviewing pictures.

- Press the zoom button toward W () to switch to the thumbnail (index) display.
  - Use the arrow pad to select the picture and press to display a single-frame.
  - Press T () on the zoom button to return to single-frame playback.



Index display

www.DataSheet4U.com

# CONNECTING THE CAMERA

## Playback on a TV

Use the video cable provided with the camera to playback recorded images on your TV. Both still pictures and movies can be played back.

- 1 Make sure that the TV and camera are turned off. Connect the VIDEO OUT jack on the camera to the video input terminal on the TV using the video cable.

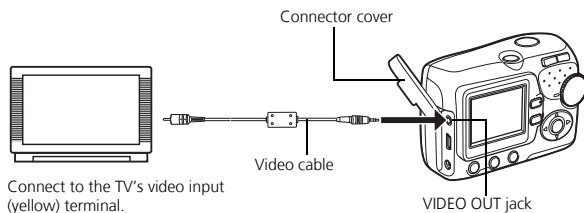

- 2 Turn the TV on and set it to the video input mode.
  - For details of switching to video input, refer to your TV's instruction manual.
- 3 Press the power switch to turn the camera on, and press .
  - The last picture taken is displayed on the TV. Use the arrow pad to select the picture you want to display.

[www.DataSheet4U.com](http://www.DataSheet4U.com)

En

## Direct Printing (PictBridge)

Using the provided USB cable, you may connect your camera directly to a PictBridge compatible printer such as the Olympus P-11 to make prints.

- 1 Connect one end of the provided USB cable into the camera's USB connector and the other end into the printer's USB connector.

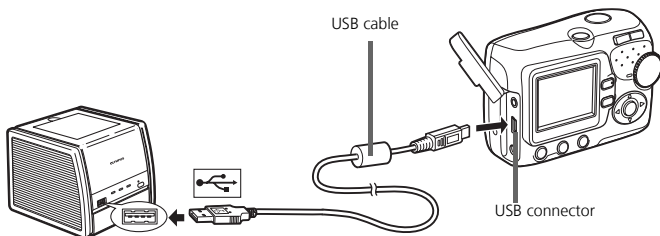

- 2 Press  $\Delta$ / $\nabla$  to select [PRINT], and press  $\odot$ .
  - While the camera is connected to a printer, the green lamp on the camera remains on.
  - ONE MOMENT is displayed and the camera and printer are connected. The PRINT MODE SELECT screen is displayed on the monitor.

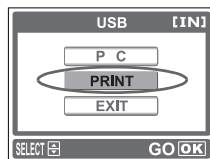

- 3 Use the arrow pad to select pictures and make prints.

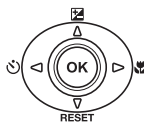
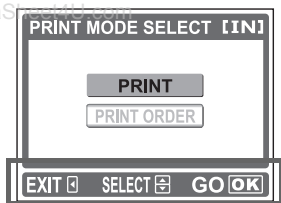

Follow the operation guide displayed here.

# OLYMPUS Master SOFTWARE

OLYMPUS Master Software: Use this software to download pictures from the camera, view, organize, retouch, e-mail and print your digital pictures and movies and more! This CD also contains the complete software reference manual in Adobe Acrobat (PDF) format.



## ● System Requirements

OS	Windows 98SE/Me/2000 Professional/XP or Mac OS X (10.2 or later)
CPU	Pentium III 500MHz/Power PC G3, or faster
RAM	128MB or more (256MB or more recommended)
Hard Disk	300MB or more free space
Connection	USB port
Monitor	1024 x 768 pixels resolution or more with a minimum of 65,536 (Windows) / 32,000 (Macintosh) colors

For the latest support information, visit the Olympus website (<http://www.olympus.com/digital>)

## ● Upgrade (OLYMPUS Master Plus)

In addition to the functions in OLYMPUS Master, the OLYMPUS Master Plus features movie editing, album printing, contact sheet printing, HTML album, free stitch panorama, CD/DVD writing functions, and a lot more, allowing you to greatly expand your digital photograph capabilities.

You need to have OLYMPUS Master installed in a computer with an internet connection.



## User Registration

Register your camera when you install OLYMPUS Master to activate your warranty, receive notifications of software and camera firmware updates, and more.

# SPECIFICATIONS

## Camera

Product type	: Digital camera (for shooting and displaying)
Recording system	
Still picture	: Digital recording, JPEG (in accordance with Design rule for Camera File system (DCF))
Applicable standards	: Exif 2.2, Digital Print Order Format (DPOF), PRINT Image Matching III, PictBridge
Movie	: QuickTime Motion JPEG support
Memory	: Internal memory, xD-Picture Card (16 MB – 1 GB)

No. of storable pictures      • When an internal memory is used.

FE-110/X-705	FE-100/X-710
7 frames (SH:2560 × 1920)	9 frames (SH:2272 × 1704)
22 frames (HQ:2560 × 1920)	28 frames (HQ:2272 × 1704)
42 frames (SQ1:1600 × 1200)	42 frames (SQ1:1600 × 1200)
160 frames (SQ2:640 × 480)	160 frames (SQ2:640 × 480)

• When using a 16MB xD-Picture Card is used.

FE-110/X-705	FE-100/X-710
4 frames (SH:2560 × 1920)	5 frames (SH:2272 × 1704)
12 frames (HQ:2560 × 1920)	16 frames (HQ:2272 × 1704)
24 frames (SQ1:1600 × 1200)	24 frames (SQ1:1600 × 1200)
91 frames (SQ2:640 × 480)	91 frames (SQ2:640 × 480)

No. of effective pixels	: 5,000,000 pixels (FE-110/X-705) 4,000,000 pixels (FE-100/X-710)
Image pickup device	: 1/2.5" CCD solid-state image pickup, 5,360,000 pixels (gross) (FE-110/X-705), 4,230,000 pixels (gross) (FE-100/X-710)
Lens	: Olympus lens 6.2 mm to 17.4 mm, f3.0 to 5.0 (equivalent to 38 mm to 106 mm lens on 35 mm camera)
Photometric system	: Center-weighted metering
Shutter speed	: 1 to 1/2000 sec. (NIGHT SCENE mode: 2 sec)
Shooting range	: 0.5 m (1.6 ft.) to ∞ (W), 0.9 m (3.0 ft.) to ∞ (T) (normal) 0.2 m (0.7 ft.) to 0.5m (1.6 ft.) (W), 0.5 m (1.6 ft.) to 0.9 m (3.0 ft.)(T) (macro mode)
Monitor	: 1.5" TFT color LCD display, 130,000 pixels
Outer connector	: DC-IN jack, USB connector (mini-B), VIDEO/OUT jack

Automatic calendar system	: 2005 up to 2099
Operating environment	
Temperature	: 0°C to 40°C (32°F to 104°F) (operation)/-20°C to 60°C (-4°F to 140°F) (storage)
Humidity	: 30% to 90% (operation)/10% to 90% (storage)
Power supply	: Two AA (R6) Oxymide batteries, two alkaline batteries or two NiMH batteries/Olympus AC adapter (optional)
Dimensions	: 87.5 mm (W) x 62.5 mm (H) x 38.5 mm (D) (3.4 x 2.5 x 1.5 in.) excluding protrusions
Weight	: 140 g (4.9 oz) without battery and card

### **xD-Picture Card**

Memory type	: NAND flash EEPROM
Operating environment	
Temperature	: 0°C to 55°C (32°F to 131°F) (operation)/ -20°C to 65°C (-4°F to 149°F) (storage)
Humidity	: 95% or lower
Power	: 3V (3.3V)
Dimensions	: 20 x 25 x 1.7 mm (0.8" x 1.0" x 0.1")

Design and specifications subject to change without notice.

[www.DataSheet4U.com](http://www.DataSheet4U.com)

**En**

## SAFETY PRECAUTIONS



### CAUTION

**RISK OF ELECTRIC SHOCK  
DO NOT OPEN**



**CAUTION:** TO REDUCE THE RISK OF ELECTRICAL SHOCK, DO NOT REMOVE COVER (OR BACK). NO USER-SERVICEABLE PARTS INSIDE. REFER SERVICING TO QUALIFIED OLYMPUS SERVICE PERSONNEL.

En



An exclamation mark enclosed in a triangle alerts you to important operating and maintenance instructions in the documentation provided with the product.



### **DANGER**

If the product is used without observing the information given under this symbol, serious injury or death may result.



### **WARNINGS**

If the product is used without observing the information given under this symbol, injury or death may result.



### **CAUTION**

If the product is used without observing the information given under this symbol, minor personal injury, damage to the equipment, or loss of valuable data may result.

#### **WARNING!**

**TO AVOID THE RISK OF FIRE OR ELECTRICAL SHOCK, NEVER DISASSEMBLE, EXPOSE THIS PRODUCT TO WATER OR OPERATE IN A HIGH HUMIDITY ENVIRONMENT.**

## General Precautions

**Read All Instructions** — Before you use the product, read all operating instructions.

Save all manuals and documentation for future reference.

**Cleaning** — Always unplug this product from the wall outlet before cleaning. Use only a damp cloth for cleaning. Never use any type of liquid or aerosol cleaner, or any type of organic solvent to clean this product.

**Attachments** — For your safety, and to avoid damaging the product, use only accessories recommended by Olympus.

**Water and Moisture** — For precautions on products with weatherproof designs, read the weatherproofing sections.

**Location** — To avoid damage to the product mount the product securely on a stable tripod, stand, or bracket.

**Power Source** — Connect this product only to the power source described on the product label.

**Lightning** — If a lightning storm occurs while using an AC adapter, remove it from the wall outlet immediately.

**Foreign Objects** — To avoid personal injury, never insert a metal object into the product.



**Heat** — Never use or store this product near any heat source such as a radiator, heat register, stove, or any type of equipment or appliance that generates heat, including stereo amplifiers.

## Handling the Camera



### WARNING

- **Do not use the camera near flammable or explosive gases.**
- **Do not use the flash on people (infants, small children, etc.) at close range.**
  - You must be at least 1 m (3 ft.) away from the faces of your subjects. Firing the flash too close to the subject's eyes could cause a momentary loss of vision.
- **Keep young children and infants away from the camera.**
  - Always use and store the camera out of the reach of young children and infants to prevent the following dangerous situations which could cause serious injury:
    - Becoming entangled in the camera strap, causing strangulation.
    - Accidentally swallowing the battery, cards or other small parts.
    - Accidentally firing the flash into their own eyes or those of another child.
    - Accidentally being injured by the moving parts of the camera.
- **Do not look at the sun or strong lights with the camera.**
- **Do not use or store the camera in dusty or humid places.**
- **Do not cover the flash with a hand while firing.**



### CAUTION

- **Stop using the camera immediately if you notice any unusual odors, noise, or smoke around it.**
  - Never remove the batteries with bare hands, which may cause a fire or burn your hands.
- **Never hold or operate the camera with wet hands.**
- **Do not leave the camera in places where it may be subject to extremely high temperatures.**
  - Doing so may cause parts to deteriorate and, in some circumstances, cause the camera to catch fire. Do not use the charger or AC adapter if it is covered (such as a blanket). This could cause overheating, resulting in fire.
- **Handle the camera with care to avoid getting a low-temperature burn.**
  - When the camera contains metal parts, overheating can result in a low-temperature burn. Pay attention to the following:
    - When used for a long period, the camera will get hot. If you hold on to the camera in this state, a low-temperature burn may be caused.
    - In places subject to extremely cold temperatures, the temperature of the camera's body may be lower than the environmental temperature. If possible, wear gloves when handling the camera in cold temperatures.

● **Be careful with the strap.**

- Be careful with the strap when you carry the camera. It could easily catch on stray objects - and cause serious damage.

**Battery Handling Precautions**

**Follow these important guidelines to prevent batteries from leaking, overheating, burning, exploding, or causing electrical shocks or burns.**

En



**DANGER**

- Use only the Olympus brand NiMH batteries and fitting charger.
- Never heat or incinerate batteries.
- Take precautions when carrying or storing batteries to prevent them from coming into contact with any metal objects such as jewelry, pins, fasteners, etc.
- Never store batteries where they will be exposed to direct sunlight, or subjected to high temperatures in a hot vehicle, near a heat source, etc.
- To prevent causing battery leaks or damaging their terminals, carefully follow all instructions regarding the use of batteries. Never attempt to disassemble a battery or modify it in any way, by soldering, etc.
- If battery fluid gets into your eyes, flush your eyes immediately with clear, cold running water and seek medical attention immediately.
- Always store batteries out of the reach of small children. If a child accidentally swallows a battery, seek medical attention immediately.



**WARNING**

- Keep batteries dry at all times.
- To prevent batteries from leaking, overheating, or causing a fire or explosion, use only batteries recommended for use with this product.
- Never mix batteries (old and new batteries, charged and uncharged batteries, batteries of different manufacture or capacity, etc.).
- Never attempt to charge alkaline, lithium or CR-V3 lithium battery packs.
- Insert the battery carefully as described in the operating instructions.
- Do not use batteries if their body is not covered by the insulating sheet or if the sheet is torn, as this may cause fluid leaks, fire, or injury.



**CAUTION**

- Do not remove batteries immediately after using the camera. Batteries may become hot during prolonged use.
- Always unload the battery from the camera before storing the camera for a long period.

- The following AA (R6) batteries cannot be used.

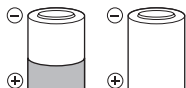

Batteries whose bodies are only partially or not at all covered by an insulating sheet.



Batteries whose  $\ominus$  terminals are raised, but not covered by an insulating sheet.

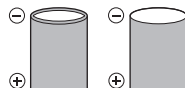

Batteries whose terminals are flat and not completely covered by an insulating sheet. (Such batteries cannot be used even if the  $\ominus$  terminals are partially covered.)

- If NiMH batteries are not charged within the specified time, stop charging them and do not use them.
- Do not use a battery if it is cracked or broken.
- If a battery leaks, becomes discolored or deformed, or becomes abnormal in any other way during operation, stop using the camera.
- If a battery leaks fluid onto your clothing or skin, remove the clothing and flush the affected area with clean, running cold water immediately. If the fluid burns your skin, seek medical attention immediately.
- Never subject batteries to strong shocks or continuous vibration.

[www.DataSheet4U.com](http://www.DataSheet4U.com)

En

## For customers in North and South America

### For customers in USA

Declaration of Conformity

Model Number : FE-110/X-705, FE-100/X-710

Trade Name : OLYMPUS

Responsible Party : **OLYMPUS IMAGING AMERICA INC.**

Address : Two Corporate Center Drive, P.O. Box 9058, Melville, NY  
11747-9058 U.S.A.

Telephone Number : 1-631-844-5000

Tested To Comply With FCC Standards

FOR HOME OR OFFICE USE

This device complies with Part 15 of the FCC rules. Operation is subject to the following two conditions:

(1) This device may not cause harmful interference.

(2) This device must accept any interference received, including interference that may cause undesired operation.

### For customers in Canada

This Class B digital apparatus meets all requirements of the Canadian Interference-Causing Equipment Regulations.

En

## Trademarks

- IBM is a registered trademark of International Business Machines Corporation.
- Microsoft and Windows are registered trademarks of Microsoft Corporation.
- Macintosh is a trademark of Apple Computer Inc.
- xD-Picture Card™ is a trademark.
- All other company and product names are registered trademarks and/or trademarks of their respective owners.
- The standards for camera file systems referred to in this manual are the "Design Rule for Camera File System/DCF" standards stipulated by the Japan Electronics and Information Technology Industries Association (JEITA).

# MEMO

---

[www.DataSheet4U.com](http://www.DataSheet4U.com)

# Table des matières

<b>ILLUSTRATION DE L'APPAREIL PHOTO .....</b>	<b>31</b>
<b>AVANT DE COMMENCER .....</b>	<b>32</b>
<b>POUR DÉMARRER .....</b>	<b>33</b>
Étape 1 POUR DÉMARRER .....	33
Étape 2 PRISE DE VUE .....	34
Étape 3 CONSULTATION OU EFFACEMENT D'UNE PHOTO .....	35
Étape 4 TRANSFERT D'IMAGES .....	36
<b>FONCTIONNEMENT DE BASE .....</b>	<b>38</b>
Astuces relatives à la prise de vue .....	38
Touche de prise de vue et touche d'affichage .....	38
Touches du mode prise de vue .....	39
Mode prise de vue .....	40
Retardateur .....	40
Mode de compensation d'exposition .....	41
Mode gros plan .....	41
Modes flash .....	42
Fonction d'économie d'énergie .....	42
<b>MENUS ET PARAMÈTRES .....</b>	<b>43</b>
Menu .....	43
Effacement de toutes les photos .....	43
Sélection d'une langue .....	44
Icônes et symboles de l'écran .....	45
Affichage des miniatures (index) .....	46
<b>CONNEXION DE L'APPAREIL PHOTO .....</b>	<b>47</b>
Affichage sur un téléviseur .....	47
Impression directe (PictBridge) .....	48
<b>LOGICIEL OLYMPUS Master .....</b>	<b>49</b>
<b>CARACTÉRISTIQUES .....</b>	<b>50</b>
<b>PRÉCAUTIONS DE SÉCURITÉ .....</b>	<b>52</b>

- Avant d'utiliser l'appareil photo, lisez attentivement ce manuel afin de garantir un fonctionnement correct de l'appareil photo.
- Nous vous recommandons de prendre des photos-test pour vous habituer à votre appareil avant de commencer à prendre de vraies photos.
- Veuillez respecter les précautions de sécurité détaillées à la fin du présent manuel.
- Il est possible que les représentations de l'écran ACL et que les illustrations de l'appareil photo utilisées dans ce manuel ne correspondent pas au produit réel. L'ensemble des images utilisées dans le présent manuel est basé sur le modèle FE-110/X-705.

# ILLUSTRATION DE L'APPAREIL PHOTO

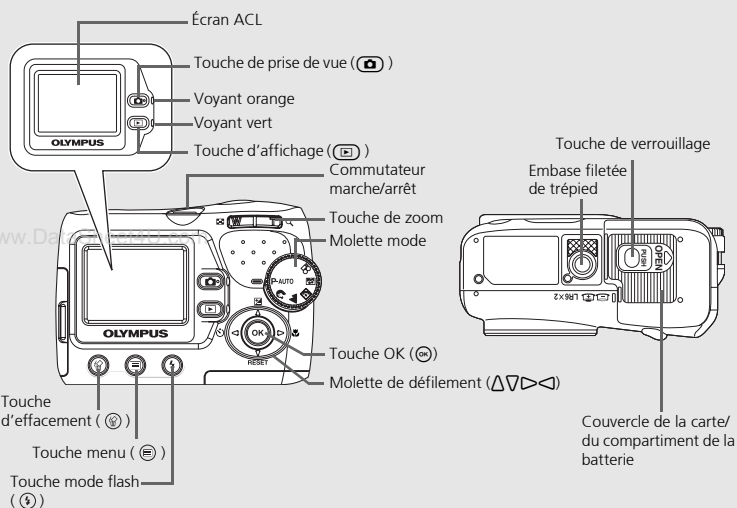
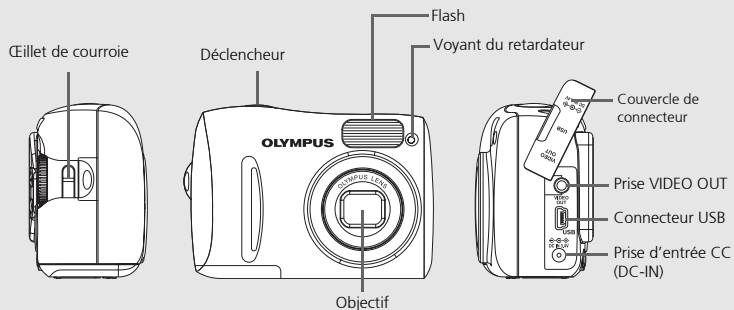

Fr

# AVANT DE COMMENCER

## Rassemblez les éléments suivants (contenu de la boîte)



Appareil photo numérique



Courroie

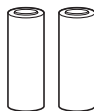

Batteries AA (R6) (deux)

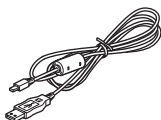

Câble USB (gris clair)

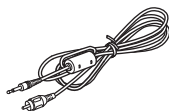

Câble vidéo (noir)



CD-ROM du logiciel  
OLYMPUS Master

Éléments non représentés : Manuel avancé (CD-ROM), Manuel de base (le présent manuel), carte de garantie. Le contenu peut varier selon le lieu d'achat.

Une carte xD-Picture Card est fournie avec le modèle FE-110/X-705 uniquement.



[www.DataSheet4U.com](http://www.DataSheet4U.com)

## Astuces

- L'appareil photo dont vous disposez est équipé d'une mémoire interne. Lorsque la carte xD-Picture Card n'est pas insérée, les images sont enregistrées dans la mémoire interne.

[www.DataSheet4U.com](http://www.DataSheet4U.com)



# 1 POUR DÉMARRER

## a. Fixez la courroie.

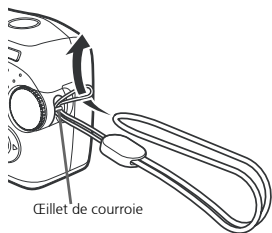

(Eillet de courroie

- Tendez la courroie afin qu'elle ne soit pas relâchée.

## b. Insérez les piles.

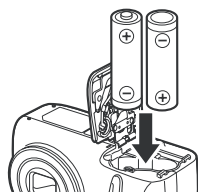
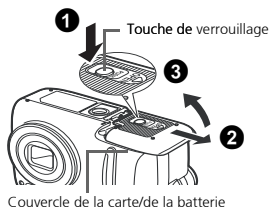

## c. Réglez la date et l'heure.

www.DataSheet4U.com

- 1 Tournez la molette mode sur **P-AUTO** et appuyez sur le commutateur d'alimentation pour mettre l'appareil photo sous tension.
- 2 Appuyez sur pour afficher l'écran du menu.

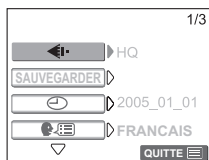

- 3 Appuyez sur pour définir un élément. Appuyez sur pour sélectionner le champ suivant.

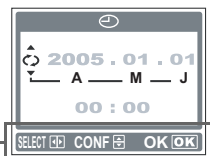

Guide d'utilisation

www.DataSheet4U.com

Fr

## 2 PRISE DE VUE

### a. Zoom

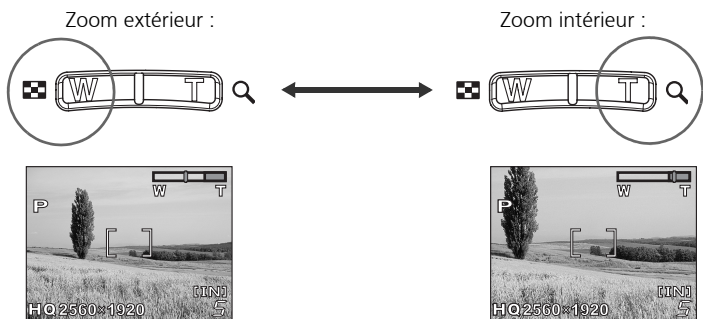

Fr

### b. Mise au point

- 1 À l'aide de l'écran, placez le repère de mise au point sur le sujet souhaité.

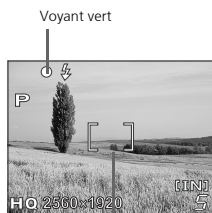

Repère de mise au point automatique

(à moitié enfoncé)

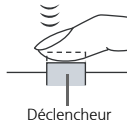

- 2 Maintenez le déclencheur à moitié enfoncé de manière à verrouiller la mise au point.
  - Le voyant vert indique que la mise au point est verrouillée.

### c. Prise de vue

- 1 Appuyez complètement sur le déclencheur pour prendre la photo.

(enfoncé complètement)

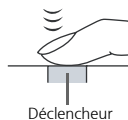

www.DataSheet4U.com





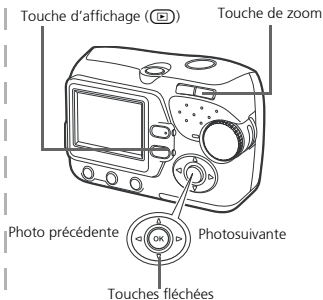

# 3 CONSULTATION OU EFFACEMENT D'UNE PHOTO

## a. Appuyez sur .

- La dernière photo prise s'affiche.



## b. Observez attentivement la photo.

- Appuyez sur T () pour agrandir l'image.
- Appuyez sur W () pour revenir à la normale.
- Appuyez sur  ou  ou  ou  pour vous déplacer dans la photo.

Appuyez sur  pour retourner au mode prise de vue.

Fr

## c. Pour effacer une photo

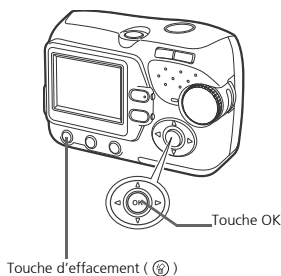

- 1 Affichez la photo que vous souhaitez effacer.
  - 2 Appuyez sur .
  - 3 Sélectionnez [OUI] et appuyez sur .
- La photo est effacée de manière définitive.

# 4 TRANSFERT D'IMAGES

## a. Installez le logiciel.

- 1 Insérez le CD-ROM OLYMPUS Master.
- 2 **Windows** : cliquez sur le bouton "OLYMPUS Master".  
**Macintosh** : double-cliquez sur l'icône du programme "d'installation".
- 3 Il vous suffit de suivre les instructions affichées à l'écran.



## b. Connectez l'appareil photo à l'ordinateur.

- 1 Connectez l'appareil photo et l'ordinateur à l'aide du câble USB (inclus).
  - L'écran s'allume automatiquement.

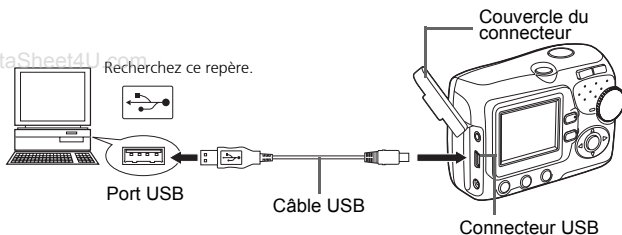

- 2 Sélectionnez [PC] sur l'écran et appuyez sur **OK**.

- L'ordinateur PC identifie l'appareil photo comme étant un lecteur de stockage amovible.

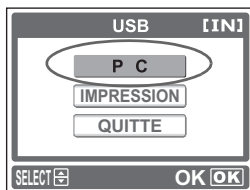

## c. Transfert d'images vers l'ordinateur

- 1 Une fois l'appareil photo connecté, ouvrez OLYMPUS Master.
  - La fenêtre [Transférer les images] s'affiche.
- 2 Sélectionnez les images que vous souhaitez transférer et cliquez sur le bouton [Transférer les images].



Si la fenêtre [Transférer les images] ne s'affiche pas automatiquement :

- a. Cliquez sur l'icône "Transférer les images" du menu principal OLYMPUS Master.
- b. Cliquez sur l'icône "À partir de l'appareil photo".



### Astuces

- Pour obtenir des informations plus détaillées au sujet de la configuration et de l'utilisation de l'appareil photo, veuillez vous reporter au "Manuel avancé" de l'appareil photo (inclus sur le CD-ROM).
- Pour plus d'informations relatives à l'utilisation des fonctions du logiciel OLYMPUS Master software qui ne sont pas mentionnées ici, ouvrez l'aide du logiciel OLYMPUS Master ou lisez le manuel de référence (format PDF). [www.DataSheet4U.com](http://www.DataSheet4U.com)

# FONCTIONNEMENT DE BASE

## Astuces relatives à la prise de vue

Il est possible que les photos apparaissent floues suite au déplacement de l'appareil photo lors de l'activation du déclencheur.

Pour éviter que l'appareil photo ne se déplace, maintenez-le fermement des deux mains, sans soulever les coudes. Maintenez vos doigts et la courroie à distance de l'objectif et du flash.

Prise en main horizontale

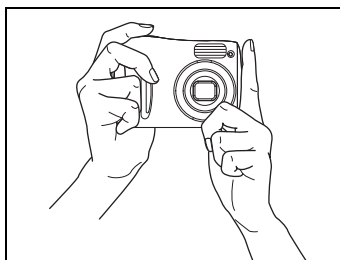

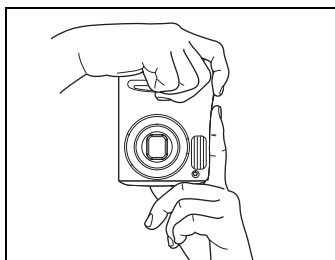

Prise en main verticale



Fr

## Touche de prise de vue et touche d'affichage

Lorsque vous prenez des photos ou effectuez des réglages de prise de vue, sélectionnez le mode de prise de vue en appuyant sur .

Lors de l'affichage, de l'édition ou de la suppression de photos que vous avez prises, sélectionnez le mode d'affichage en appuyant sur .

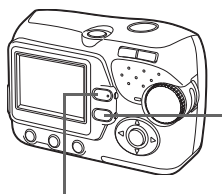



Touche  (mode prise de vue)

Touche  (mode d'affichage)

## Touches du mode prise de vue

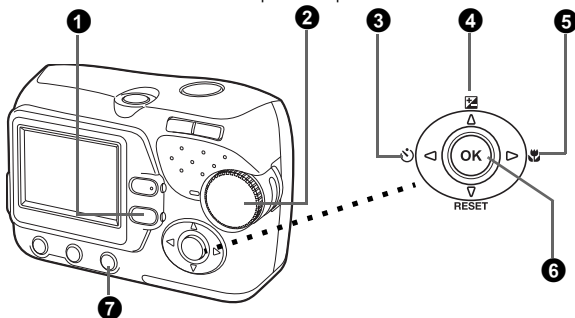
Lorsque le mode prise de vue est activé, utilisez les touches suivantes pour accéder rapidement à certaines des fonctions les plus fréquemment utilisées.



**1 Touche  (mode d'affichage)**

Le mode d'affichage de l'appareil photo est activé.

**2 Molette mode**

L'appareil photo dispose non seulement d'un mode par défaut (**P-AUTO**) mais également de modes présentant des paramètres adaptés à l'objectif souhaité et aux conditions de prise de vue.

**3 Touche  (retardateur)**

Activez le retardateur pour retarder la prise de vue d'environ 12 secondes à compter du moment où vous appuyez sur le déclencheur.

**4 Touche  (compensation d'exposition)**

Utilisez ce paramètre pour surexposer (+) ou sous-exposer (-) une photo.



**5 Touche  (mode gros plan)**

Utilisez le mode gros plan ou très gros plan lors de la prise de photos en gros plan (gros plan d'une fleur, par exemple).

**6 Touche  (OK)**

Appuyez sur cette touche pour confirmer les paramètres.

**7  bouton (mode flash)**

Sélectionnez l'un des quatre modes flash : automatique,  (réduction de l'effet « yeux rouges »),  (flash d'appoint) ou  (flash désactivé).

## Mode prise de vue

Faites tourner la molette mode pour sélectionner un mode prise de vue. Lorsque vous tournez la molette mode, la description correspondant à chaque mode s'affiche à l'écran.

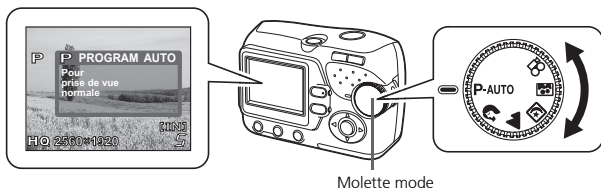

Fr

- P-AUTO PROGRAM AUTO
- SCENE NUIT
- PORTRAIT
- AUTO PORTRAIT
- PAYSAGE
- MOVIE

## Retardateur

- 1 Appuyez sur  $\triangleleft$  (☺).
  - L'écran des réglages du retardateur apparaît.
- 2 Appuyez sur  $\triangle\triangledown$  pour sélectionner [ACTIVE] et appuyez ensuite sur  $\odot$ .
  - Vous pouvez également définir le mode en appuyant plusieurs fois sur  $\triangleleft$  (☺).
- 3 Enfoncez complètement le déclencheur pour prendre la photo.
  - Le voyant du retardateur s'allume pendant environ dix secondes lorsque vous appuyez sur le déclencheur. Il se met ensuite à clignoter. Lorsque le voyant clignote depuis environ deux secondes, la photo est prise.

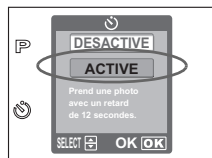

Voyant du retardateur





## Mode de compensation d'exposition

- 1 Appuyez sur  $\Delta$  (☒).
  - L'écran des réglages du retardateur apparaît.
- 2 Appuyez sur  $\triangleleft$   $\trianglerightarrow$  pour sélectionner la valeur de compensation d'exposition et appuyez ensuite sur  $\odot$ .
  - Sélectionnez une valeur [ + ] pour augmenter la luminosité de l'image ou une valeur [ - ] pour réduire la luminosité de l'image.
- 3 Prenez la photo.

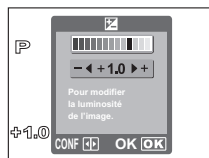

## Mode gros plan

- ☘ Ce mode vous permet de prendre des photos à 20 cm du sujet (Lorsque le zoom est en position grand angle).
  - s☘ Utilisez ce mode pour prendre des photos à 2 cm du sujet. La position du zoom est fixée automatiquement et ne peut pas être modifiée.
- 1 Appuyez sur  $\trianglerightarrow$  (☘).
    - L'écran de paramétrage de la prise de vue en gros plan s'affiche.
  - 2 Appuyez sur  $\Delta$   $\nabla$  pour sélectionner le mode gros plan et appuyez ensuite sur  $\odot$ .
    - Vous pouvez également définir le mode en appuyant plusieurs fois sur  $\trianglerightarrow$  (☘).
  - 3 Prenez la photo.

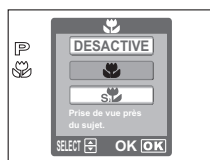

## Modes flash

- Appuyez sur la touche mode flash (⚡).
  - L'écran de paramétrage du flash s'affiche.
- Appuyez sur  $\Delta \nabla$  pour sélectionner le mode flash et appuyez ensuite sur  $\odot$ .
  - Vous pouvez également définir le mode flash en appuyant plusieurs fois sur  $\odot$ .
- Enfoncez le déclencheur jusqu'à mi-course.
  - Dans les conditions de déclenchement du flash,  $\text{⚡}$  s'allume (flash en attente).
- Appuyez complètement sur le déclencheur pour prendre la photo.

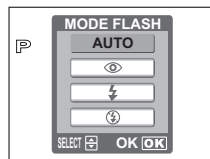

### Plage de fonctionnement du flash :

W (max.) : 0,2 m à 3,8 m environ

T (max.) : 0,5 m à 2,2 m environ

Fr



Icône	Mode flash	Description
Aucune indication	Flash automatique	Le flash se déclenche automatiquement lorsque l'éclairage est faible ou à contre-jour.
	Flash de réduction de l'effet « yeux rouges »	Ce mode permet de réduire de manière importante l'effet « yeux rouges » en émettant une série de pré-éclairs avant de déclencher le flash principal.
	Flash d'appoint	Le flash se déclenche quelles que soient les conditions d'éclairage.
	Flash désactivé	Le flash ne se déclenche pas, même dans des situations de faible éclairage.

## Fonction d'économie d'énergie

- Pour économiser l'énergie des piles, l'appareil passe automatiquement en mode veille (état d'attente) au bout de 30 secondes d'inactivité. L'écran ACL s'éteint automatiquement. Appuyez sur le déclencheur,  $\text{Ⓜ}$  ou  $\text{Ⓜ}$  pour allumer l'écran ACL. Vous pouvez sélectionner la durée après laquelle l'appareil photo entre automatiquement en mode veille.
- Si vous n'utilisez pas l'appareil photo dans les 30 minutes qui suivent l'activation du mode de veille, l'appareil photo rentre l'objectif et s'éteint automatiquement. Si vous souhaitez utiliser de nouveau l'appareil photo, rallumez-le.

# MENUS ET PARAMÈTRES

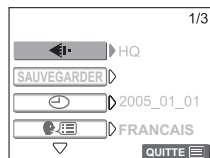

## Menu

- 1 Appuyez sur  pour afficher le menu de l'appareil photo à l'écran.
- 2 Utilisez les touches fléchées et la touche  pour naviguer et sélectionner les éléments de menu.





## Effacement de toutes les photos

- 1 En mode d'affichage, sélectionnez [CONF MEMOIRE]\* dans le menu et appuyez ensuite sur .  
\*Lorsqu'une carte est insérée dans l'appareil photo, [CONFIG CARTE] s'affiche.

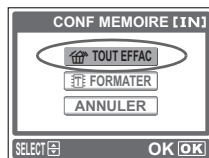
- 2 Appuyez sur  pour sélectionner [ TOUT EFFAC] et appuyez ensuite sur .



[www.DataSheet4U.com](http://www.DataSheet4U.com)

- 3 Appuyez sur  pour sélectionner [OUI] et appuyez ensuite sur .
  - Toutes les photos sont effacées.



[www.DataSheet4U.com](http://www.DataSheet4U.com)



## Sélection d'une langue

Vous pouvez sélectionner la langue d'affichage à l'écran. Les langues disponibles varient en fonction du lieu d'achat de l'appareil photo.

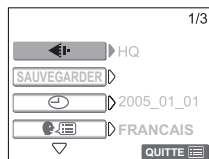
- 1 Appuyez sur .
  - L'écran du menu s'affiche.





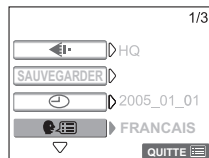

Écran du menu

- 2 Appuyez sur  pour sélectionner .
  - L'élément sélectionné s'affiche en jaune.



Fr

- 3 Appuyez sur  ou sur .
- 4 Appuyez sur  pour sélectionner une langue et appuyez ensuite sur .



[www.DataSheet4U.com](http://www.DataSheet4U.com)

[www.DataSheet4U.com](http://www.DataSheet4U.com)

# Icônes et symboles de l'écran

## ● Écran - mode prise de vue

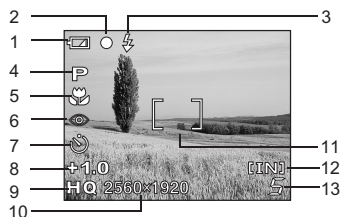

Image fixe



Vidéo

	Éléments	Indication
1	Contrôle de la batterie	=pleine puissance,  =faible puissance
2	Voyant vert	○ =verrouillage de la mise au point automatique
3	Veille du flash Avertissement de bougé/chargement du flash	(Allumé) (Clignote)
4	Mode prise de vue	
5	Mode gros plan Mode super gros plan	 
6	Mode flash	
7	Retardateur	
8	Compensation d'exposition	-2,0 – +2,0
9	Mode d'enregistrement	SHQ, HQ, SQ1, SQ2
10	Taille d'image	•FE-110/X-705 2560×1920, 1600×1200, 640×480, 320×240, 160×120 •FE-100/X-710 2272×1704, 1600×1200, 640×480, 320×240, 160×120
11	Repère de mise au point automatique	[ ]
12	Mémoire	[IN] (mémoire interne), [xD] (carte)
13	Nombre d'images fixes pouvant être stockées Durée d'enregistrement restante	5 00:36

## ● Écran - mode d'affichage



Image fixe



Vidéo

	Éléments	Indication
1	Contrôle de la batterie	= pleine puissance,  = faible puissance
2	Mémoire	[IN] (mémoire interne), [xD] (carte)
3	Réservation d'impression/nombre d'impressions	x10
4	Numéro de fichier	100-0018
5	Protection	
6	Mode d'enregistrement	SHQ, HQ, SQ1, SQ2
7	Taille d'image	<ul style="list-style-type: none"> <li>•FE-110/X-705 2560×1920, 1600×1200, 640×480, 320×240, 160×120</li> <li>•FE-100/X-710 2272×1704, 1600×1200, 640×480, 320×240, 160×120</li> </ul>
8	Compensation d'exposition	-2,0 – +2,0
9	Date et heure	'05.10.10 12:30
10	Nombre de cadres Temps écoulé/durée totale de l'enregistrement (vidéo)	18 00:00/0015
11	Vidéo	

## Affichage des miniatures (index)

Cette fonction vous permet d'afficher simultanément plusieurs photos à l'écran lors de la consultation.

- Appuyez sur la touche de zoom W () pour activer l'affichage des miniatures (index).
  - Utilisez la molette de défilement pour sélectionner la photo et appuyez sur pour afficher une seule image.
  - Appuyez sur T () sur le bouton de zoom pour revenir à l'affichage d'une seule image.

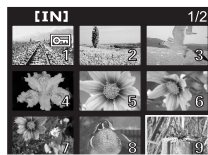



# CONNEXION DE L'APPAREIL PHOTO

## Affichage sur un téléviseur

Utilisez le câble vidéo fourni avec l'appareil photo pour lire les images enregistrées sur votre téléviseur. La lecture peut porter sur des images fixes ou des vidéos.

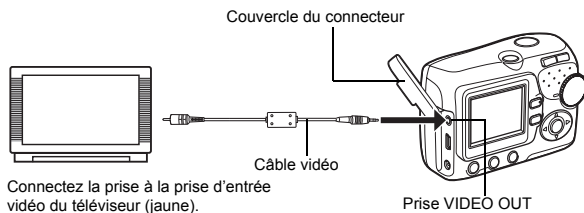
- 1 Assurez-vous que le téléviseur et l'appareil photo sont éteints. Connectez la prise Prise VIDEO OUT de l'appareil photo à la prise d'entrée vidéo du téléviseur à l'aide du câble vidéo.



- 2 Allumez le téléviseur et activez le mode entrée vidéo.
  - Pour plus de détails au sujet de l'activation de l'entrée vidéo, reportez-vous au manuel du téléviseur.
- 3 Appuyez sur le commutateur marche/arrêt pour allumer l'appareil photo, puis sur .
  - La dernière photo prise est affichée sur le téléviseur. Utilisez les touches fléchées pour sélectionner la photo que vous voulez afficher.

## Impression directe (PictBridge)

Le câble USB fourni vous permet de connecter directement l'appareil photo à une imprimante compatible PictBridge, telle que l'imprimante Olympus P-11, pour procéder aux impressions.

- 1 Connectez une extrémité du câble USB fourni au connecteur USB de l'appareil photo et l'autre extrémité au connecteur USB de l'imprimante.

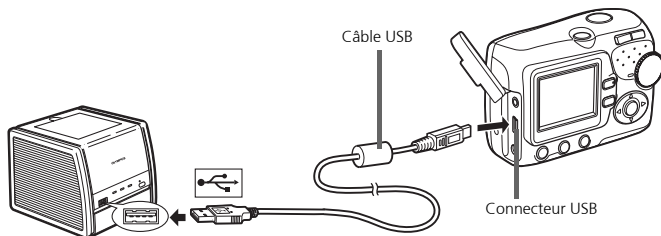

- 2 Appuyez sur  $\Delta$ / $\nabla$  pour sélectionner [IMPRESSION] et appuyez ensuite sur  $\odot$ .

- Lorsque l'appareil photo est connecté à un ordinateur, le voyant vert de l'appareil photo reste allumé.
- UN MOMENT s'affiche, puis l'appareil photo et l'imprimante sont connectés. L'écran SEL MD IMP s'affiche.

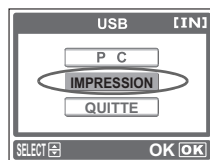

- 3 Utilisez les touches fléchées pour sélectionner les photos et procéder à des impressions. [www.impressions.4U.com](http://www.impressions.4U.com)

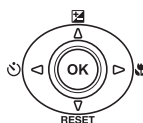
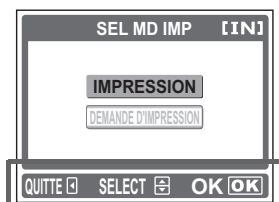

Suivez les instructions de fonctionnement affichées ici.



# LOGICIEL OLYMPUS Master

Logiciel OLYMPUS Master : utilisez ce logiciel pour télécharger des images à partir de l'appareil photo, pour afficher, organiser, retoucher, envoyer par courrier électronique et imprimer vos photos numériques, vos vidéos, etc. ! Ce CD-ROM contient également le manuel de référence complet (au format Adobe Acrobat (PDF)).



## ● Configuration système requise

Système d'exploitation	Windows 98SE/Me/2000 Professional/XP ou Mac OS X (version 10,2 ou une version plus récente)
Unité centrale	Pentium III 500MHz/Power PC G3 ou plus rapide
Mémoire vive	128 Mo ou plus (256 Mo ou plus recommandés)
Disque dur	Espace disponible de 300 Mo ou plus
Connexion	Port USB
Écran ACL	Résolution de 1024 x 768 pixels ou plus, avec 65.536 (Windows)/32.000 (Macintosh) couleurs minimum

**Pour obtenir les dernières informations relatives à la prise en charge, consultez le site Internet Olympus**

(<http://www.olympus.com/digital>)

## ● Mise à niveau (OLYMPUS Master Plus)

OLYMPUS Master Plus dispose non seulement des fonctions OLYMPUS Master, il vous permet également de modifier les vidéos, d'imprimer des albums ou des bandes témoins, de créer des albums HTML, des panoramas sans reliure, de graver des CD/DVD, etc. Vous bénéficiez ainsi de possibilités bien plus nombreuses en matière de photographie numérique.

OLYMPUS Master doit être installé sur votre ordinateur et vous devez disposer d'une connexion Internet.



## Enregistrement de l'utilisateur

Enregistrez votre appareil photo lors de l'installation de OLYMPUS Master de manière à activer votre garantie, à recevoir des notifications lors des mises à jour du logiciel et du micrologiciel de l'appareil photo, etc.

# CARACTÉRISTIQUES

## Appareil photo

Type de produit : Appareil photo numérique (prise de vue et affichage)

Système d'enregistrement

Images fixes : Enregistrement numérique, JPEG (selon la règle de conception des systèmes de fichiers d'appareil photo (DCF))

Normes applicables : Exif 2.2, Digital Print Order Format (DPOF), PRINT Image Matching III, PictBridge

Vidéo : Prise en charge de QuickTime Motion JPEG

Mémoire : Mémoire interne, xD-Picture Card (16 Mo - 1 Go)

Nombre d'images pouvant être stockées

• En cas d'utilisation d'une carte mémoire

FE-110/X-705	FE-100/X-710
7 images (SH:2560 x 1920)	9 images (SH:2272 x 1704)
22 images (HQ:2560 x 1920)	28 images (HQ:2272 x 1704)
42 images (SQ1:1600 x 1200)	42 images (SQ1:1600 x 1200)
160 images (SQ2:640 x 480)	160 images (SQ2:640 x 480)

• En cas d'utilisation d'une xD-Picture Card de 16 Mo.

FE-110/X-705	FE-100/X-710
4 images (SH:2560 x 1920)	5 images (SH:2272 x 1704)
12 images (HQ:2560 x 1920)	16 images (HQ:2272 x 1704)
24 images (SQ1:1600 x 1200)	24 images (SQ1:1600 x 1200)
91 images (SQ2:640 x 480)	91 images (SQ2:640 x 480)

Nombre de pixels effectifs : 5.000.000 pixels (FE-110/X-705)  
: 4.000.000 pixels (FE-100/X-710)

Capteur d'image : capture d'image CCD 1/2,5",  
5.360.000 pixels (bruts) (FE-110/X-705),  
4.230.000 pixels (bruts) (FE-100/X-710)

Objectif : Objectif Olympus 6,2 mm à 17,4 mm, f3,0 à 5,0  
(équivalent à un objectif 38 mm à 106 mm sur un appareil photo 35 mm)

Système de mesure : Métrage pondéré au centre

Vitesse d'obturation : 1 à 1/2000 s. (mode SCENE NUIT : 2 s.)

Portée de prise de vue : 0,5 m à ∞ (W), 0,9 m à ∞ (T) (normal)  
0,2 m à 0,5 m (W), 0,5 m à 0,9 m (T) (mode gros plan)

Écran ACL : Écran couleur à cristaux liquides TFT de 1,5", 130.000 pixels

Connecteurs externes : Prise d'entrée CC (DC-IN), connecteur USB (mini-B), Prise VIDEO OUT

[www.DataSheet4U.com](http://www.DataSheet4U.com)

Calendrier automatique	: de 2005 à 2099
Conditions de fonctionnement	
Température	: 0°C à 40°C (32°F à 104°F) (fonctionnement)/-20°C à 60°C (-4°F à 140°F) (stockage)
Humidité	: 30% à 90% (fonctionnement)/10% à 90% (stockage)
Alimentation	: Deux piles Oxyride, deux piles alcalines ou deux piles NiMH, toutes de type AA (R6)/Un adaptateur secteur Olympus (optionnel)
Dimensions	: 87,5 mm (largeur) × 62,5 mm (hauteur) × 38,5 mm (profondeur) saillies non incluses
Poids	: 140 g sans batterie, ni carte

#### **xD-Picture Card**

Type de mémoire	: flash NAND EEPROM
Conditions de fonctionnement	
Température	: 0 à 55 °C (fonctionnement)/-20 à 65 °C (stockage)
Humidité	: 95 % ou inférieure
Alimentation	: 3V (3,3V)
Dimensions	: 20 × 25 × 1,7 mm

La conception et les caractéristiques peuvent être modifiées sans préavis.

[www.DataSheet4U.com](http://www.DataSheet4U.com)

Fr

## PRÉCAUTIONS DE SÉCURITÉ



### ATTENTION

RISQUE DE DÉCHARGE ÉLECTRIQUE NE PAS OUVRIR



**ATTENTION** : POUR RÉDUIRE LE RISQUE DE DÉCHARGE ÉLECTRIQUE, NE PAS RETIRER LA PARTIE AVANT NI LE DOS DU BÔÎTIER. AUCUNE PIÈCE À L'INTÉRIEUR NE PEUT ÊTRE RÉPARÉE PAR L'UTILISATEUR. SE RÉFÉRER À DU PERSONNEL DE DÉPANNAGE QUALIFIÉ POUR UNE RÉPARATION.



Le point d'exclamation à l'intérieur d'un triangle vous alerte sur certains points importants concernant le maniement et l'entretien de l'appareil figurant dans la documentation fournie avec le produit.



### DANGER

Si le produit est utilisé sans respecter les informations données sous ce symbole, des blessures graves, voire mortelles pourraient en résulter.



### AVERTISSEMENT

Si le produit est utilisé sans respecter les informations données sous ce symbole, des blessures voire la mort pourraient en résulter.



### ATTENTION

Si le produit est utilisé sans observer les informations données sous ce symbole, des blessures, des dommages à l'appareil ou des pertes de données pourraient en résulter.

### AVERTISSEMENT !

**POUR ÉVITER LES RISQUES D'INCENDIE OU DE DÉCHARGE ÉLECTRIQUE, NE JAMAIS EXPOSER CE PRODUIT À L'EAU NI LE FAIRE FONCTIONNER DANS UN ENVIRONNEMENT TRÈS HUMIDE.**

Fr

www.DataSheet4U.com

## Précautions générales

**Lire toutes les instructions** — Avant d'utiliser l'appareil, lire toutes les instructions de fonctionnement. Conservez tous les manuels et la documentation pour pouvoir vous y référer ultérieurement.

**Nettoyage** — Toujours débrancher ce produit de la prise de courant avant nettoyage. N'utiliser qu'un chiffon humide pour le nettoyage. Ne jamais utiliser de produits de nettoyage liquides ou aérosols, ni de solvants organiques pour nettoyer ce produit.

**Accessoires** — Pour votre sécurité, et pour éviter d'endommager le produit, n'utiliser que des accessoires recommandés par Olympus.

**Eau et humidité** — Pour les précautions concernant les appareils manufacturés de manière à résister aux intempéries, lire les sections correspondantes.

**Emplacement** — Pour éviter de l'endommager, installez solidement l'appareil sur un trépied, un support ou une console stables.

**Alimentation** — Ne raccorder ce produit qu'à la source d'alimentation décrite sur l'étiquette du produit.

www.DataSheet4U.com

**Foudre** — Si un orage avec foudre se produit alors qu'un adaptateur secteur est utilisé, débranchez-le immédiatement de la prise murale.

**Corps étrangers** — Pour éviter toute blessure, n'insérez jamais de pièce métallique dans l'appareil.

**Chaleur** — Ne jamais utiliser ni ranger ce produit près d'une source de chaleur telle qu'un radiateur, un accumulateur de chaleur, ou tout type d'appareil qui génère de la chaleur, comprenant les amplificateurs.

## Maniement de l'appareil



### AVERTISSEMENT

- **Ne pas utiliser l'appareil à proximité de gaz inflammables ou explosifs.**
- **Ne pas utiliser le flash de très près sur des personnes (bébés, jeunes enfants, etc.).**
  - Vous devez être à une distance d'au moins 1 mètre du visage de vos sujets. Déclencher le flash trop près des yeux d'un sujet peut entraîner une perte de vision momentanée.
- **Ne pas laisser l'appareil à la portée des enfants.**
  - Toujours utiliser et ranger l'appareil hors de la portée des jeunes enfants et des bébés pour empêcher les situations dangereuses suivantes qui pourraient causer des blessures graves :
    - Devenir enroulé dans la courroie de l'appareil, causant la strangulation.
    - Avaler accidentellement la batterie, des cartes ou d'autres petites pièces.
    - Déclencher accidentellement le flash dans leurs yeux ou ceux d'un autre enfant.
    - Se blesser accidentellement par des parties en mouvement de l'appareil.
- **Ne pas regarder le soleil ni des lumières puissantes avec l'appareil.**
- **Ne pas utiliser ni ranger l'appareil dans des endroits poussiéreux ou humides.**
- **Ne pas couvrir le flash avec une main pendant le déclenchement.**



### ATTENTION

- **Arrêter immédiatement d'utiliser l'appareil si vous remarquez une odeur, un bruit anormal ou de la fumée provenant de l'appareil.**
  - Ne jamais retirer les piles à mains nues, vous risquez un incendie ou de vous brûler les mains.
- **Ne jamais tenir ou utiliser l'appareil photos avec des mains mouillées.**

● **Ne pas laisser l'appareil dans des endroits où il pourrait être soumis à des températures très élevées.**

- Ceci pourrait causer une détérioration de certaines pièces et, dans certaines circonstances, l'appareil pourrait prendre feu. Ne pas utiliser le chargeur ni un adaptateur secteur s'il est couvert (par exemple par une couverture). Ce qui pourrait causer une surchauffe, débouchant sur un incendie.

● **Manipuler l'appareil soigneusement afin d'éviter une brûlure à basse température.**

- Lorsque l'appareil contient des parties métalliques, une surchauffe peut déboucher sur une brûlure à basse température. Faire attention aux points suivants :
  - Utilisé pendant une longue durée, l'appareil devient chaud. Si vous tenez l'appareil dans ces conditions, une brûlure à basse température risque de se produire.
  - Dans des endroits sujets à des températures très froides, la température du corps de l'appareil peut être plus basse que la température ambiante. Si possible, mettre des gants en tenant l'appareil à des températures basses.

● **Faire attention avec la courroie.**

- Faire attention avec la courroie en portant l'appareil. Elle peut facilement s'accrocher à des objets sur le passage et causer des dommages sérieux.

Fr

Précautions de manipulation de la batterie

**Veillez suivre ces consignes importantes pour éviter le coulage du liquide des batteries, une génération de chaleur, des brûlures, une explosion, ou causer des décharges électriques ou brûlures.**



**DANGER**

- Utiliser uniquement des piles NiMH de marque Olympus et le chargeur correspondant.
- Ne jamais chauffer ni mettre au feu des piles.
- Prendre des précautions en transportant ou rangeant des piles pour éviter qu'elles viennent en contact avec des objets métalliques comme des bijoux, des épingles à cheveux, des agrafes, etc.
- Ne jamais ranger des piles où elles seraient exposées en plein soleil, ou sujettes à des températures élevées dans un véhicule chaud, près d'une source de chaleur, etc.
- Pour éviter de causer des coulages de liquide de pile ou d'endommager leurs bornes, respecter scrupuleusement toutes les instructions concernant l'usage des piles. Ne jamais tenter de démonter une pile ni la modifier, en soudant, etc.
- Si du liquide de pile entrait dans vos yeux, les laver immédiatement avec de l'eau claire et froide du robinet et consulter immédiatement un médecin.
- Toujours ranger les piles hors de la portée des jeunes enfants. Si un enfant avale accidentellement une pile, consulter immédiatement un médecin.

[www.DataSheet4U.com](http://www.DataSheet4U.com)

**AVERTISSEMENT**

- Maintenir à tout moment les piles au sec.
- Pour éviter un coulage du liquide des piles, une génération de chaleur ou de causer un incendie ou une explosion, n'utiliser que les piles recommandées pour l'utilisation avec ce produit.
- Ne jamais mélanger des piles/batteries (piles neuves et usagées, batteries chargées et déchargées, piles/batteries de fabricant ou de capacité différente, etc.).
- Ne jamais tenter de recharger des piles alcalines, lithium ni des batteries CR-V3 au lithium.
- Insérer soigneusement la pile comme indiqué dans les instructions de fonctionnement.
- Ne pas utiliser de piles dont le corps n'est pas recouvert d'une feuille isolante ou si la feuille est déchirée, cela pourrait causer une fuite de liquide, un incendie ou des blessures.

**ATTENTION**

- Ne pas retirer les piles immédiatement après avoir utilisé l'appareil photo. Les piles peuvent devenir chaudes lors d'une utilisation prolongée.
- Toujours retirer la batterie de l'appareil avant de le ranger pour une longue durée.

- Les piles AA suivantes ne peuvent pas être utilisées.

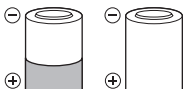

Piles dont le corps n'est que partiellement recouvert ou pas du tout recouvert par une feuille isolante.



Piles dont la borne  $\ominus$  est relevée, mais pas recouverte par une feuille isolante.

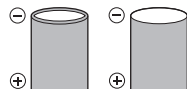

Piles dont les bornes sont plates et pas complètement recouvertes par une feuille isolante. (De telles piles ne peuvent pas être utilisées même si la borne  $\ominus$  est partiellement recouverte.)

- Si des piles NiMH ne sont pas chargées au bout de la durée spécifiée, arrêter de les charger et ne pas les utiliser.
- Ne pas utiliser une batterie si elle est endommagée ou cassée.
- Si une pile fuit, se décolore ou se déforme, ou présente tout autre aspect anormal, arrêter d'utiliser l'appareil photo.
- Si du liquide de pile coule sur vos vêtements ou sur votre peau, retirer le vêtement et laver immédiatement la zone affectée avec de l'eau claire et froide du robinet. Si le liquide vous brûle la peau, consulter immédiatement un médecin.
- Ne jamais soumettre les piles à des chocs violents ni à des vibrations continues.

## Pour les utilisateurs d'Amérique du Nord et du Sud

### Pour les utilisateurs aux États-Unis

Déclaration de conformité

Modèle numéro : FE-110/X-705, FE-100/X-710

Marque : OLYMPUS

Organisme responsable : **OLYMPUS IMAGING AMERICA INC.**

Adresse : Two Corporate Center Drive, P.O. Box 9058, Melville,  
NY 11747-9058 États-Unis

Numéro de téléphone : 1-631-844-5000

Testé pour être en conformité avec la réglementation FCC

POUR L'UTILISATION A LA MAISON OU AU BUREAU

Cet appareil est conforme aux normes de la Section 15 des directives FCC. Son utilisation est soumise aux deux conditions suivantes :

(1) Cet appareil ne doit pas causer de brouillage radioélectrique.

(2) Cet appareil doit pouvoir résister à toutes les interférences, y compris celles susceptibles d'entraver son bon fonctionnement.

### Pour les utilisateurs au Canada

Cet appareil numérique de la catégorie B est conforme à la législation canadienne sur les appareils générateurs de parasites.

Fr

## Marques déposées

- IBM est une marque déposée de la société International Business Machines Corporation.
- Microsoft et Windows sont des marques déposées de la société Microsoft Corporation.
- Macintosh est une marque de Apple Computer Inc.
- xD-Picture Card™ est une marque déposée.
- Tous les autres noms de sociétés et appellations de produits sont des marques, déposées ou non, des propriétaires respectifs.
- Les normes pour les systèmes de fichiers d'appareil photo indiquées dans ce manuel sont les normes "Design Rule for Camera File System/DCF" stipulées par l'association JEITA (Japan Electronics and Information Technology Industries Association).



# MEMO

---

[www.DataSheet4U.com](http://www.DataSheet4U.com)

# Contenido

<b>DIAGRAMA DE LA CÁMARA .....</b>	<b>59</b>
<b>ANTES DE COMENZAR .....</b>	<b>60</b>
<b>INTRODUCCIÓN .....</b>	<b>61</b>
Paso 1 INTRODUCCIÓN.....	61
Paso 2 TOMA DE FOTOGRAFÍAS .....	62
Paso 3 REVISIÓN O BORRADO DE FOTOGRAFÍAS .....	63
Paso 4 TRANSFERENCIA DE IMÁGENES .....	64
<b>UTILIZACIÓN BÁSICA.....</b>	<b>66</b>
Consejos de fotografía .....	66
Botón de fotografía y botón de reproducción.....	66
Botones de modo de fotografía.....	67
Modo de fotografía.....	68
Disparador automático.....	68
Modo de compensación de la exposición .....	69
Modo macro .....	69
Modos flash .....	70
Función de ahorro de energía.....	70
<b>MENÚ Y AJUSTES .....</b>	<b>71</b>
Menú.....	71
Borrado de todas las fotografías.....	71
Selección de idioma .....	72
Símbolos e iconos de monitor .....	73
Visualización de miniaturas (índice) .....	74
<b>CONEXIÓN DE LA CÁMARA .....</b>	<b>75</b>
Reproducción en un televisor .....	75
Impresión directa (PictBridge) .....	76
<b>SOFTWARE OLYMPUS Master .....</b>	<b>77</b>
<b>ESPECIFICACIONES.....</b>	<b>78</b>
<b>PRECAUCIONES DE SEGURIDAD .....</b>	<b>80</b>

- Antes de empezar a usar la cámara, lea con atención este manual para garantizar un uso correcto.
- Antes de tomar fotografías importantes, le recomendamos que realice varias tomas de prueba para familiarizarse con el uso de su cámara.
- Tenga en cuenta las precauciones de seguridad que figuran al final de este manual.
- Las imágenes de la pantalla LCD y las ilustraciones de la cámara que se usan en este manual pueden diferir del producto real. Para este manual, todas las imágenes se basan en el modelo FE-110/X-705.

[www.DataSheet4U.com](http://www.DataSheet4U.com)

# DIAGRAMA DE LA CÁMARA

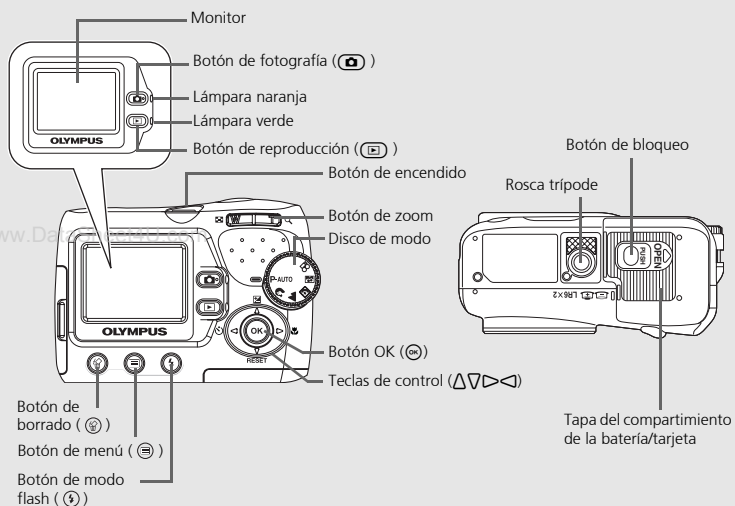
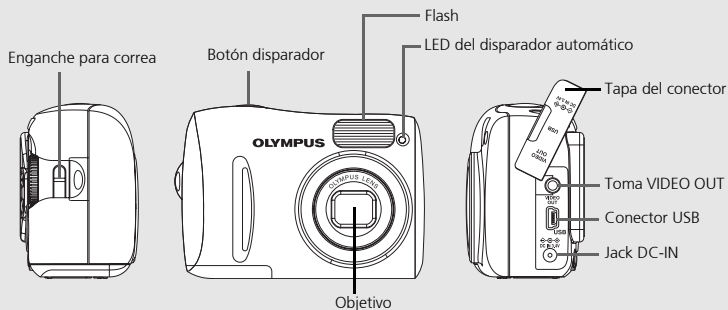

Es

# ANTES DE COMENZAR

## Reúna estos elementos (contenido de la caja)



Cámara digital



Correa

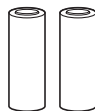

Pilas AA (R6) (dos)

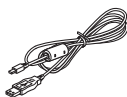

Cable USB (gris claro)

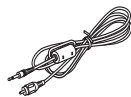

Cable de vídeo (negro)



CD-ROM del software  
OLYMPUS Master

Elementos no mostrados: Manual Avanzado (CD-ROM), Manual Básico (este manual), tarjeta de garantía. El contenido puede variar en función de la ubicación de compra.

Se incluye una tarjeta xD-Picture Card con el modelo FE-110/X-705 solamente.



[www.DataSheet4U.com](http://www.DataSheet4U.com)

## Consejos

- La cámara que ha adquirido incluye su propia memoria interna. Aunque no se inserte una tarjeta xD-Picture Card, las fotografías se guardarán en la memoria interna.

[www.DataSheet4U.com](http://www.DataSheet4U.com)

# 1 INTRODUCCIÓN

## a. Enganche la correa

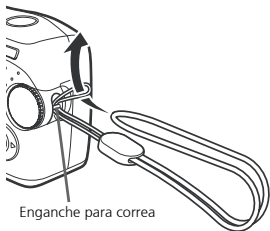

Enganche para correa

- Tire de la correa para que quede apretada y no se suelte.

## b. Inserte las pilas

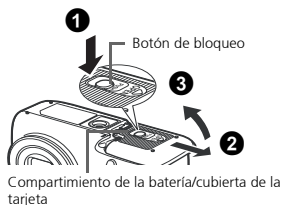

Compartimento de la batería/cubierta de la tarjeta

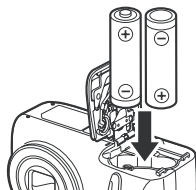

Es

## c. Ajuste la fecha y hora

www.DataSheet4U.com

- 1 Gire el disto de modo hasta **P-AUTO** y presione el botón de encendido para encender la cámara.
- 2 Presione para visualizar la pantalla de menú.
- 3 Presione para activar una opción Presione para seleccionar el siguiente campo.

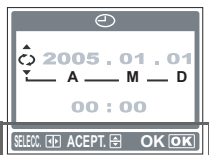
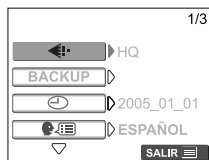

Instrucciones

www.DataSheet4U.com

# 2 TOMA DE FOTOGRAFÍAS

## a. Zoom

Zoom de alejamiento:

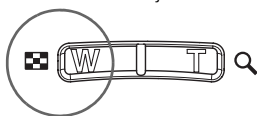

Zoom de acercamiento:



Es

## b. Enfoque

- 1 Con el monitor, coloque la marca de objetivo de enfoque automático (AF) sobre el sujeto.

Lámpara verde



Marca de objetivo de enfoque automático (AF)

(media presión)



Botón disparador

- 2 Mantenga presionado el botón disparador (media presión) para bloquear el enfoque.
  - La lámpara verde indica que el enfoque está bloqueado.

## c. Tome la fotografía

- 1 Presione el botón disparador a fondo para tomar la fotografía.

(presión completa)



Botón disparador

www.DataSheet4U.com

# 3 REVISIÓN O BORRADO DE FOTOGRAFÍAS

## a. Presione

- Se mostrará la última fotografía tomada.

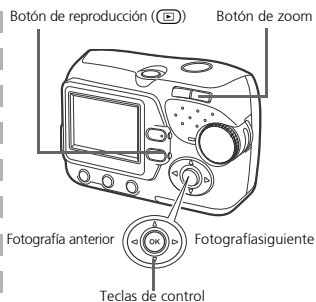

## b. Mire más de cerca



- Presione T (Q) para ampliar la imagen.
- Presione W (R) para volver al modo normal.
- Presione  $\Delta/\nabla$  o  $\triangleleft/\triangleright$  para desplazarse por la imagen.



Presione  para volver al modo de fotografía.

Es

## c. Para borrar una fotografía

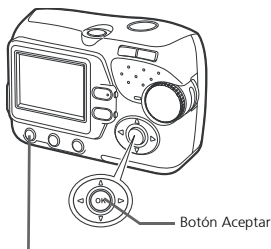

Botón de borrado (☒)



- 1 Visualice la fotografía que desea borrar.
- 2 Presione .
- 3 Seleccione [SI] y presione .
  - La fotografía se borrará de forma permanente.

# 4 TRANSFERENCIA DE IMÁGENES

## a. Instale el software

- 1 Inserte el CD-ROM de OLYMPUS Master.
- 2 **Windows:** Haga clic en el botón "OLYMPUS Master".  
**Macintosh:** Haga doble clic en el icono "Installer".
- 3 Basta con seguir las instrucciones en pantalla.





Es

## b. Conecte la cámara al ordenador

- 1 Conecte la cámara y el ordenador usando el cable USB (incluido).
  - El monitor se encenderá automáticamente.

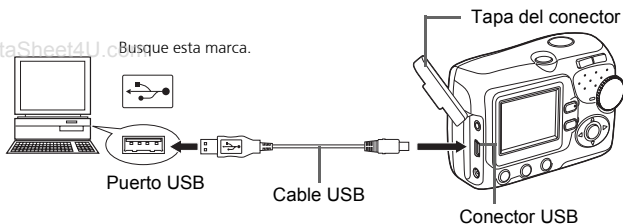
www.DataSheet4U.com



- 2 Seleccione [PC] en el monitor y presione .

- El PC reconocerá ahora la cámara como una unidad de almacenamiento extraíble.

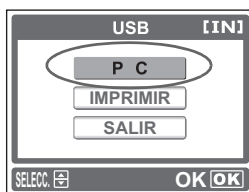

www.DataSheet4U.com



## c. Transfiera imágenes al ordenador

- 1 Con la cámara conectada, abra OLYMPUS Master.
  - Se mostrará la ventana [Transferencia de imágenes].
- 2 Seleccione las imágenes que desee transferir y haga clic en el botón [Transferencia de imágenes].



Si la ventana [Transferencia de imágenes] no se muestra automáticamente:

- a. Haga clic en el icono "Transferencia de imágenes" en el menú principal de OLYMPUS Master.
- b. Haga clic en el icono "Desde cámara".

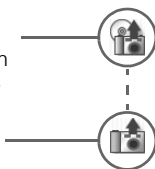

Es

[www.DataSheet4U.com](http://www.DataSheet4U.com)

### Consejos

- Para obtener información más detallada acerca de la configuración y el uso de la cámara, consulte el "Manual Avanzado" de la cámara que se incluye en formato CD-ROM.
- Para obtener información sobre el uso de otras funciones del software OLYMPUS Master no mencionadas anteriormente, abra "Ayuda" en el software OLYMPUS Master o lea el manual de referencia (formato PDF). [www.DataSheet4U.com](http://www.DataSheet4U.com)

# UTILIZACIÓN BÁSICA

## Consejos de fotografía

Es posible que las imágenes aparezcan borrosas como resultado de mover la cámara mientras está presionado el botón disparador.

Para evitar que la cámara se mueva, sujétela firmemente con ambas manos y mantenga los codos a los lados. Mantenga los dedos y la correa alejados del objetivo y el flash.

Sujeción horizontal

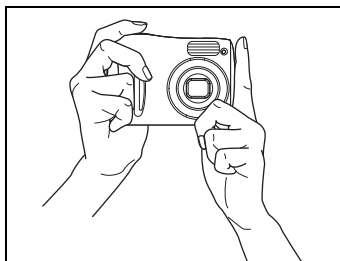

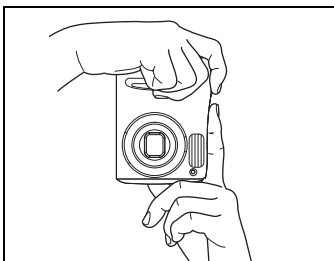

Sujeción vertical





Es

## Botón de fotografía y botón de reproducción

Cuando tome fotografías o realice ajustes de fotografía, seleccione el modo de toma de fotografías presionando .

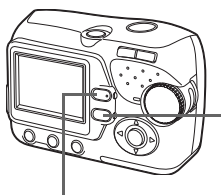
Cuando visualice, edite o borre fotografías que usted haya tomado, seleccione el modo de reproducción presionando .



Botón  (modo de fotografía)

Botón  (modo de reproducción)

## Botones de modo de fotografía

En modo de fotografía, utilice estos botones para acceder de forma rápida a algunas de las funciones utilizadas con más frecuencia.

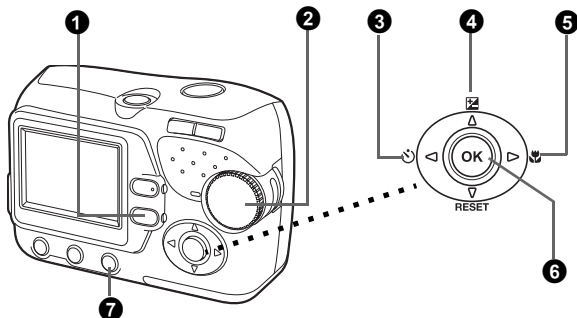

**1 Botón  (modo de reproducción)**

La cámara cambia al modo de reproducción.

**2 Disco de modo**

Además del modo predeterminado (**P-AUTO**), existen otros modos con ajustes óptimos para su propósito y condiciones de fotografía.

**3 Botón  (disparador automático)**

Seleccione el disparador automático para retrasar la fotografía 12 segundos aproximadamente desde el momento en que se presione el botón disparador.

**4 Botón  (compensación de la exposición)**

Utilice este ajuste para aumentar (+) o reducir (-) la exposición de una fotografía.



**5 Botón  (modo macro)**

Utilice el modo macro o supermacro al tomar fotografías en primer plano como la de una flor.

**6 Botón  (OK)**

Presione para confirmar los ajustes.

**7 Botón  (modo flash)**

Seleccione entre 4 modos de flash: Automático,  (reducción de ojos rojos),  (flash de relleno) o  (flash desactivado).

Es

## Modo de fotografía

Gire el disco de modo para seleccionar un modo de fotografía. A medida que gira el disco de modo, la descripción de cada modo se muestra en el monitor.

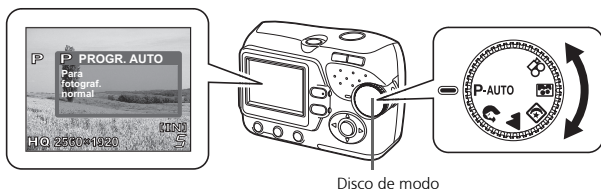

- **P-AUTO** PROGR. AUTO
- RETRATO
- PAISAJE
- ESC.NOCT.
- AUTO - RETRATO
- VIDEO

Es

## Disparador automático

- 1 Presione ().
  - Aparecerá la pantalla de opciones del disparador automático.
- 2 Presione para seleccionar [ON], y presione .
  - También puede realizar los ajustes presionando () repetidamente.
- 3 Presione el botón disparador a fondo para tomar la fotografía.
  - La lámpara del disparador automático se enciende durante aproximadamente 10 segundos, y luego empieza a parpadear. Después de parpadear durante 2 segundos, se toma la foto.

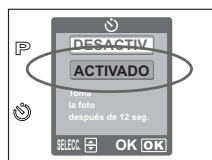

Lámpara de disparador automático



## Modo de compensación de la exposición

- 1 Presione  $\Delta$  (☒).
  - Se muestra la pantalla de ajustes para la compensación de la exposición.
- 2 Presione  $\triangleleft$   $\triangleright$  para seleccionar el valor de compensación de la exposición, y presione  $\odot$ .
  - Seleccione un valor [ + ] para aumentar el brillo de la imagen o un valor [ - ] para oscurecerla.
- 3 Tome la fotografía.



## Modo macro

- 🌸 Este modo le permite tomar fotografías a una distancia de 20 cm del sujeto (Cuando el objetivo zoom está ajustado en granangular máximo).
- 🌸 Utilice este modo para tomar fotografías a una distancia de 2 cm del sujeto. La posición del zoom se fija automáticamente y no se puede cambiar.

- 1 Presione  $\triangleright$  (🌸).
  - Se muestra la pantalla de ajustes para la fotografía macro.
- 2 Presione  $\Delta$   $\nabla$  para seleccionar el modo macro, y presione  $\odot$ .
  - También puede realizar los ajustes presionando  $\triangleright$  (🌸) repetidamente.
- 3 Tome la fotografía.

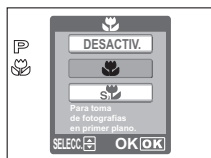

Es

## Modos flash

- Presione el botón de modo flash (⚡).
  - Se muestra la pantalla de ajustes de flash.
- Presione  $\Delta \nabla$  para seleccionar el modo flash, y presione  $\text{OK}$ .
  - También puede realizar los ajustes presionando (⚡) repetidamente.
- Presione a medias el botón obturador.
  - Si las condiciones requieren que el flash se dispare, se enciende ⚡ (flash en espera).
- Presione el botón disparador a fondo para tomar la fotografía.

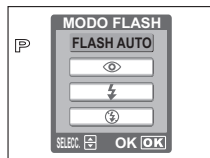

### Alcance del flash:

W (máx.): Aprox. de 0,2 m a 3,8 m

T (máx.): Aprox. de 0,5 m a 2,2 m

Es

Icono	Modo flash	Descripción
Sin indicación	Flash automático	El flash se dispara automáticamente en condiciones de baja iluminación o de contraluz.
	Flash con reducción de ojos rojos	El modo flash con reducción de ojos rojos reduce significativamente este fenómeno emitiendo destellos previos antes de que se dispare el flash regular.
	Flash de relleno	El flash se dispara independientemente de la luz disponible.
	Flash desactivado	El flash no se dispara, aún en condiciones de baja iluminación.

www.DataSheet4U.com



## Función de ahorro de energía

- Para ahorrar energía de las pilas, la cámara entra automáticamente en el modo de reposo y deja de funcionar tras aproximadamente 30 segundos de inactividad. El monitor se apaga automáticamente. Presione el botón obturador,  $\text{OK}$  o  $\text{OK}$  para encender el monitor. Puede seleccionar el lapso de tiempo después del cual la cámara entra automáticamente en el modo de reposo.
- Si la cámara no se utiliza durante 30 minutos una vez que ha pasado al modo inactivo, retrae de forma automática el objetivo y se apaga. Para volver a utilizar la cámara, enciéndala nuevamente.

www.DataSheet4U.com

# MENÚ Y AJUSTES

## Menú

- 1 Presione  para visualizar el menú de la cámara en el monitor.
- 2 Para navegar y seleccionar opciones de menú, utilice las teclas de control y .

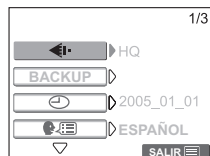



## Borrado de todas las fotografías

- 1 En el modo de reproducción, seleccione [CONF. MEM.]\* en el menú y presione .  
\*Cuando se inserta una tarjeta en la cámara se visualiza [CONFIG. TARJ.].

- 2 Presione  para seleccionar  BORRAR TODO] y presione .



[www.DataSheet4U.com](http://www.DataSheet4U.com)

- 3 Presione  para seleccionar [SI], y presione .
  - Se borran todas las fotografías.



Es

## Selección de idioma

Puede seleccionar un idioma para la visualización en pantalla. Los idiomas disponibles varían en función de la zona en la que adquirió esta cámara.

- 1 Presione [M].
  - Aparece la pantalla de menú.

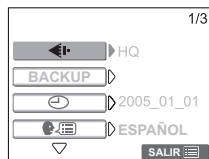

Pantalla de menú

- 2 Presione [V] para seleccionar [M].
  - La opción seleccionada se muestra en amarillo.

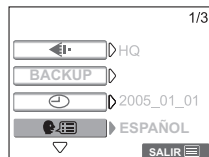

Es

- 3 Presione [OK] o [D].
- 4 Presione [V] para seleccionar un idioma, y presione [OK].



[www.DataSheet4U.com](http://www.DataSheet4U.com)

[www.DataSheet4U.com](http://www.DataSheet4U.com)



## Símbolos e iconos de monitor

### ● Monitor: Modo de fotografía

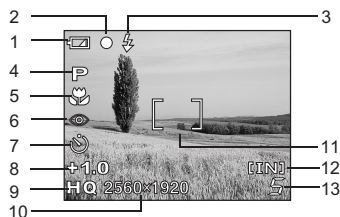

Fotografía



Video

	Opción	Indicaciones
1	Verificación de la batería	=potencia total, =potencia baja
2	Lámpara verde	○= Bloqueo de enfoque automático
3	Flash en espera Aviso de movimiento de la cámara / Carga del flash	(Se enciende) (Parpadea)
4	Modo de fotografía	
5	Modo macro Modo Supermacro	
6	Modo de flash	
7	Disparador automático	
8	Compensación de la exposición	-2,0 – +2,0
9	Modo de grabación	SHQ, HQ, SQ1, SQ2
10	Tamaño de imagen	•FE-110/X-705 2560×1920, 1600×1200, 640×480, 320×240, 160×120 •FE-100/X-710 2272×1704, 1600×1200, 640×480, 320×240, 160×120
11	Marca de objetivo de enfoque automático (AF)	[ ]
12	Memoria actual	[IN] (memoria interna), [xD] (tarjeta)
13	Número de fotografías almacenables Tiempo de grabación restante	5 00:36

Es

## ● Monitor: Modo de reproducción

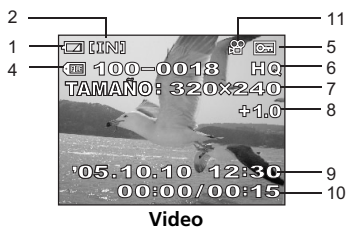
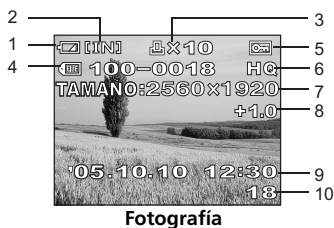

Opción	Indicaciones
1 Verificación de la batería	=potencia total, =potencia baja
2 Memoria actual	[IN] (memoria interna), [xD] (tarjeta)
3 Reserva de impresión/número de copias	x10
4 Número de archivo	100-0018
5 Protección	
6 Modo de grabación	SHQ, HQ, SQ1, SQ2
7 Tamaño de imagen	<ul style="list-style-type: none"> <li>•FE-110/X-705 2560×1920, 1600×1200, 640×480, 320×240, 160×120</li> <li>•FE-100/X-710 2272×1704, 1600×1200, 640×480, 320×240, 160×120</li> </ul>
8 Compensación de la exposición	-2,0 – +2,0
9 Fecha y hora	'04.10.10 12:30
10 Número de cuadro Tiempo de reproducción/tiempo total de grabación (video)	18 00:00/0015
11 Video	

## Visualización de miniaturas (índice)

Esta función permite visualizar varias fotografías al mismo tiempo en el monitor al revisar las fotografías.

- Presione el botón de zoom hacia W () para cambiar a la visualización de miniaturas (índice).
  - Utilice las teclas de control para seleccionar la fotografía y presione para visualizar un solo cuadro.
  - Presione T () en el botón del zoom para volver a la reproducción de un solo cuadro.

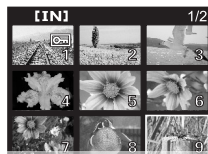



# CONEXIÓN DE LA CÁMARA

## Reproducción en un televisor

Emplee el cable de vídeos suministrado con la cámara para reproducir en el televisor imágenes grabadas. Se pueden reproducir tanto imágenes fijas como vídeos.

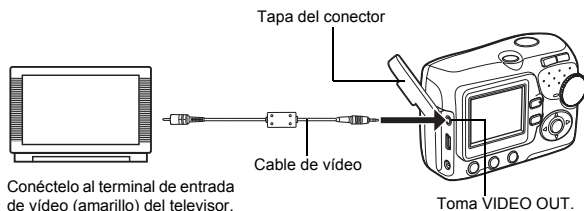
- 1 Compruebe que el televisor y la cámara estén apagados. Conecte la toma VIDEO OUT. de la cámara al terminal de entrada de vídeo del televisor usando el cable de vídeo.



- 2 Encienda el televisor y cambie al modo de entrada de vídeo.
  - Para más información sobre cómo cambiar a entrada de vídeo, consulte el manual de instrucciones del televisor.
- 3 Presione el interruptor de encendido para encender la cámara y presione .
  - En el televisor aparecerá la última fotografía tomada. Utilice las teclas de control para seleccionar la fotografía que desea visualizar.

[www.DataSheet4U.com](http://www.DataSheet4U.com)

## Impresión directa (PictBridge)

Mediante el cable USB, puede conectar su cámara directamente a una impresora compatible con el estándar PictBridge, como el modelo Olympus P-11, para realizar copias.

- 1 Conecte un extremo del cable USB suministrado al conector USB de la cámara y el otro extremo al conector USB de la impresora.

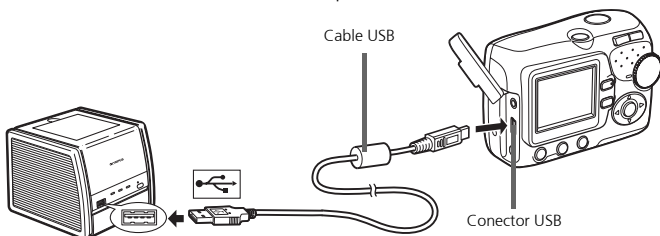

- Es** 2 Presione  $\Delta$ / $\nabla$  para seleccionar [IMPRIMIR], y presione



- Mientras la cámara está conectada a una impresora, la lámpara verde de la cámara permanece encendida.
- Aparece el mensaje UN MOMENTO y se conectan la cámara y la impresora. Aparece la pantalla S MODO IMP en el monitor.

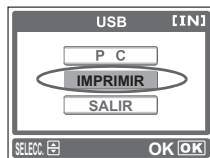

- 3 Utilice las teclas de control para seleccionar fotografías y realizar copias.

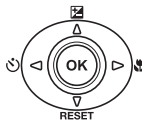
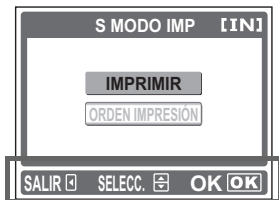

Siga las instrucciones que se muestran aquí.

# SOFTWARE OLYMPUS Master

Software OLYMPUS Master: Utilice este software para descargar fotografías desde la cámara, visualizar, organizar, retocar, enviar por correo electrónico e imprimir vídeos y fotografías digitales y mucho más. Este CD también contiene el manual de referencia del software completo en formato Adobe Acrobat (PDF).



## ● Requisitos del sistema

SO	Windows 98SE/Me/2000 Professional/XP o Mac OS X (10.2 o posterior)
CPU	Pentium III 500MHz/Power PC G3 o superior
RAM	128 MB o más (se recomienda al menos 256 MB)
Disco Duro	300 MB o más de espacio libre
Conexión	Puerto USB
Monitor	1024 x 768 píxeles de resolución o más con un mínimo de 65.536 (Windows) / 32.000 (Macintosh) colores

Es

**Para obtener la información de asistencia más actualizada, visite el sitio Web de Olympus**  
(<http://www.olympus.com/digital>)

## ● Actualización (OLYMPUS Master Plus)

Además de las funciones de OLYMPUS Master, OLYMPUS Master Plus ofrece la edición de vídeos, impresión de álbumes, impresión de hojas de contactos, álbum HTML, coser panorama gratuito, funciones de escritura en CD/DVD y muchas más opciones, lo que permite ampliar en gran medida las posibilidades de fotografía digital.

Debe tener OLYMPUS Master instalado en su equipo con una conexión de Internet.



### Registro de usuario

Registre su cámara al instalar OLYMPUS Master para activar la garantía, recibir notificaciones de actualizaciones de software y firmware de la cámara y mucho más.

# ESPECIFICACIONES

## Cámara

- Tipo de producto : Cámara digital (para fotografía y reproducción)
- Sistema de grabación
- Fotografía : Grabación digital, JPEG (de acuerdo con las normas de diseño para sistema de archivos de cámara (DCF))
- Estándares aplicables : Exif 2.2, Formato de reserva de impresión digital (DPOF), PRINT Image Matching III, PictBridge
- Vídeo : Compatible con QuickTime Motion JPEG
- Memoria : Memoria interna, tarjeta xD-Picture Card (16 MB – 1 GB)

Núm. de fotografías almacenables

- Si se utiliza una memoria interna.

FE-110/X-705	FE-100/X-710
7 cuadros (SH:2560 x 1920)	9 cuadros (SH:2272 x 1704)
22 cuadros (HQ:2560 x 1920)	28 cuadros (HQ:2272 x 1704)
42 cuadros (SQ1:1600 x 1200)	42 cuadros (SQ1:1600 x 1200)
160 cuadros (SQ2:640 x 480)	160 cuadros (SQ2:640 x 480)

- Si se utiliza una tarjeta xD-Picture Card de 16 MB.

FE-110/X-705	FE-100/X-710
4 cuadros (SH:2560 x 1920)	5 cuadros (SH:2272 x 1704)
12 cuadros (HQ:2560 x 1920)	16 cuadros (HQ:2272 x 1704)
24 cuadros (SQ1:1600 x 1200)	24 cuadros (SQ1:1600 x 1200)
91 cuadros (SQ2:640 x 480)	91 cuadros (SQ2:640 x 480)

- Núm. de píxeles efectivos : 5.000.000 de píxeles (FE-110/X-705)  
: 4.000.000 de píxeles (FE-100/X-710)
- Dispositivo de captura de imagen : Elemento captador de imágenes CCD de estado sólido, de 1/2,5", 5.360.000 píxeles (en total) (FE-110/X-705), 4.230.000 píxeles (en total) (FE-100/X-710)
- Objetivo : Objetivo Olympus 6,2 mm a 17,4 mm, f3,0 a 5,0 (equivalente a un objetivo de 38 mm a 106 mm en una cámara de 35 mm)
- Sistema fotométrico : Sistema de medición centrada
- Velocidad de obturación : 1 a 1/2.000 s (2 s en el modo ESC.NOCT.)
- Alcance de fotografía : 0,5 m a ∞ (W), 0,9 m a ∞ (T) (normal)  
0,2 m a 0,5m (W), 0,5 m a 0,9 m (T) (modo macro)
- Monitor : Pantalla LCD TFT en color de 1,5", 130.000 píxeles
- Conector exterior : Jack DC-IN, conector USB (mini-B), toma VIDEO OUT.

Es

www.DataSheet4U.com

www.DataSheet4U.com

Sistema de calendario automático	: 2005 hasta 2099
Entorno de funcionamiento	
Temperatura	: 0°C a 40° C (32°F a 104°F) (funcionamiento)/-20°C a 60°C (-4°F a 140°F) (almacenamiento)
Humedad	: 30% a 90% (funcionamiento)/10% a 90% (almacenamiento)
Fuente de alimentación	: Dos baterías Oxyride, dos baterías alcalinas o dos baterías NiMH tipo AA (R6)/Adaptador de CA Olympus (opcional)
Dimensiones	: 87,5 mm (An.) × 62,5 mm (Alt.) × 38,5 mm (P.) excluyendo los salientes
Peso	: 140 g sin la batería ni la tarjeta

### **Tarjeta xD-Picture Card**

Tipo de memoria	: NAND flash EEPROM
Ambiente de funcionamiento	
Temperatura	: 0°C a 55°C (funcionamiento)/ -20°C a 65°C (guardada)
Humedad	: 95% o inferior
Alimentación	: 3V (3,3V)
Dimensiones	: 20 × 25 × 1,7 mm

El diseño y las especificaciones están sujetas a cambios sin previo aviso.

[www.DataSheet4U.com](http://www.DataSheet4U.com)

**Es**

## PRECAUCIONES DE SEGURIDAD



### PRECAUCIÓN

RIESGO DE DESCARGAS ELÉCTRICAS NO ABRIR



**PRECAUCIÓN:** PARA REDUCIR EL RIESGO DE DESCARGAS ELÉCTRICAS, NO RETIRE LA CUBIERTA (O PARTE TRASERA). EN EL INTERIOR NO HAY PIEZAS QUE EL USUARIO PUEDA REPARAR. REMITA LA REPARACIÓN A PERSONAL DE SERVICIO ESPECIALIZADO OLYMPUS.



El signo de admiración dentro de un triángulo equilátero tiene como finalidad alertar al usuario de la existencia de importantes instrucciones de operación y mantenimiento en la documentación suministrada con el producto.



### PELIGRO

Si el producto es utilizado sin observar la información representada bajo este símbolo, podría causar serias lesiones o muerte.



### ADVERTENCIA

Si el producto es utilizado sin observar la información representada bajo este símbolo, podría causar serias lesiones o muerte.



### PRECAUCIÓN

Si el producto es utilizado sin observar la información representada bajo este símbolo, podría causar lesiones personales menores, daños al equipo, o pérdida de datos importantes.

### ¡ADVERTENCIA!

PARA EVITAR EL RIESGO DE INCENDIO O DESCARGAS ELÉCTRICAS, NUNCA EXPONGA ESTE PRODUCTO AL AGUA NI LO UTILICE EN UN ENTORNO MUY HÚMEDO.

Es

## Precauciones Generales

**Lea todas las instrucciones** — Antes de utilizar este producto, lea todas las instrucciones operativas. Conserve todos los manuales y documentación para referencia futura.

**Limpieza** — Siempre desenchufe el producto de la toma de corriente antes de limpiarlo. Para la limpieza use sólo un paño húmedo. Nunca use limpiadores líquidos o aerosoles, ni solventes orgánicos de ningún tipo para limpiar este producto.

**Accesorios** — Para su seguridad y evitar daños al producto, utilice únicamente los accesorios recomendados por Olympus.

**Agua y humedad** — Para obtener información sobre las precauciones de los productos diseñados a prueba de la intemperie, consulte las secciones de resistencia a la intemperie.

**Ubicación** — Para evitar daños al producto, móntelo de forma segura sobre un trípode, base o soporte estable.

**Fuentes de alimentación** — Conecte este producto únicamente con la fuente de alimentación descrita en la etiqueta del producto.

www.DataSheet4U.com



**Rayos** — Si se produce una tormenta eléctrica mientras está utilizando un adaptador de CA, retírelo de la toma de corriente mural inmediatamente.

**Objetos extraños** — Para evitar daños personales, nunca inserte objetos de metal en el producto.

**Calentadores** — Nunca utilice ni guarde este producto cerca de fuentes de calor, tales como radiadores, rejillas de calefacción, estufas o cualquier tipo de equipo o aparato generador de calor, incluyendo amplificadores estéreo.

## Manejo de la Cámara



### ADVERTENCIA

- **No utilice la cámara cerca de gases inflamables o explosivos.**
- **No utilice el flash a corta distancia de las personas (especialmente niños menores y mayores, etc.).**
  - Debe mantener, por lo menos, una distancia de 1 m de la cara de los sujetos. Si dispara el flash demasiado cerca de los ojos del sujeto, podría causar la pérdida de visión momentánea.
- **Mantenga a los niños menores y mayores alejados de la cámara.**
  - Utilice y guarde siempre la cámara fuera del alcance de los niños menores y mayores, para prevenir las siguientes situaciones de peligro que podrían causarles serias lesiones:
    - Enredarse con la correa de la cámara, ocasionando asfixia.
    - Ingerir accidentalmente una pila, tarjetas, u otras piezas pequeñas.
    - Disparar el flash accidentalmente hacia sus propios ojos o hacia los ojos de otro niño.
    - Lesionarse accidentalmente con las piezas móviles de la cámara.
- **No apunte la cámara directamente al sol o a luces fuertes.**
- **No utilice ni guarde la cámara en lugares polvorientos o húmedos.**
- **No cubra el flash con la mano mientras efectúa el disparo.**



### PRECAUCIÓN

- **Interrumpa inmediatamente el uso de la cámara si percibe algún olor, ruido o humo extraño alrededor de la misma.**
  - Nunca retire las baterías con las manos descubiertas, ya que podría causar un incendio o quemarle las manos.
- **Nunca sostenga ni utilice la cámara con las manos mojadas.**
- **No deje la cámara en lugares donde pueda estar sujeta a temperaturas extremadamente altas.**
  - Si lo hace puede provocar el deterioro de las piezas y, en algunas circunstancias, provocar que se prenda fuego. No utilice el cargador o el adaptador CA si está cubierto (por ejemplo con una frazada). Esto podría causar recalentamiento, resultando en incendio.
- **Manipule la cámara con cuidado para evitar una quemadura de baja temperatura.**

- Ya que la cámara contiene partes metálicas, el recalentamiento puede resultar en una quemadura de baja temperatura. Preste atención a lo siguiente:
  - Cuando la utilice durante un largo período, la cámara se recalentará. Si mantiene a la cámara en este estado, podría causar una quemadura de baja temperatura.
  - En lugares sujetos a temperaturas extremadamente bajas, la temperatura de la carcasa de la cámara puede ser más baja que la temperatura ambiente. Si es posible, póngase guantes cuando manipule la cámara en temperaturas bajas.

● **Tenga cuidado con la correa.**

- Tenga cuidado con la correa cuando transporte la cámara. Podría engancharse en objetos – sueltos y provocar daños graves.

**Precauciones acerca del uso de las pilas**

Siga estas importantes indicaciones para evitar que se produzcan fugas, recalentamientos, incendios o explosión de las pilas, o que cause descargas eléctricas o quemaduras.

Es



**PELIGRO**

- Utilice únicamente baterías NiMH de la marca Olympus y el cargador correspondiente.
- Nunca caliente ni incinere las pilas.
- Tome precauciones al transportar o guardar las pilas a fin de evitar que entren en contacto con objetos metálicos, tales como alfileres, horquillas, cierres, etc.
- Nunca guarde las pilas en lugares donde queden expuestas a la luz solar directa o sujetas a altas temperaturas en el interior de un vehículo con calefacción, cerca de fuentes de calor, etc.<sup>1</sup>
- Para evitar que ocurran fugas de líquido de las pilas o daños de sus terminales, siga cuidadosamente todas las instrucciones respectivas al uso de las pilas. Nunca intente desarmar una pila ni modificarla de ninguna manera, por soldadura, etc.
- Si el fluido de la pila penetrara en sus ojos, lávelos de inmediato con agua corriente fresca y limpia, y solicite atención médica inmediatamente.
- Siempre guarde las pilas fuera del alcance de los niños menores. Si un niño ingiere una pila accidentalmente, solicite atención médica inmediatamente.



**ADVERTENCIA**

- Conserve las pilas siempre secas.
- Para evitar que ocurran fugas de líquido, recalentamiento de las pilas, o que causen incendio o explosión, utilice únicamente las pilas recomendadas para este producto.
- Nunca mezcle las pilas (pilas nuevas con usadas, pilas cargadas con descargadas, pilas de distinta marca o capacidad, etc.).
- Nunca intente recargar las pilas alcalinas, baterías de litio o las baterías de litio CR-V3.
- Inserte la batería con cuidado como se describe en las instrucciones operativas.

- No utilice baterías si el cuerpo no está cubierto con una lámina aislante o si dicha lámina está perforada, ya que podría provocar fugas de líquido, incendio o lesión.

## PRECAUCIÓN

- No retire las baterías inmediatamente después de utilizar la cámara. Las baterías pueden recalentarse durante el uso prolongado.
- Siempre retire la batería de la cámara antes de guardar la cámara por un largo tiempo.

- Las siguientes pilas AA no pueden ser utilizadas.

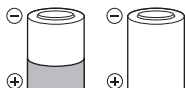

Pilas parcialmente cubiertas o no cubiertas totalmente por una hoja aislante.



Pilas con terminales en relieve, pero no cubiertos por una hoja aislante.

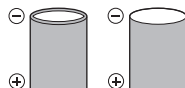

Pilas con terminales planos, pero no completamente cubiertos por una hoja aislante (Tales pilas no pueden ser usadas aunque los terminales (-) estén parcialmente cubiertos).

- Si las pilas de NiMH no se recargan dentro del tiempo especificado, interrumpa la recarga de las mismas y no las use.
- No utilice una pila si está rajada o quebrada.
- Si se producen fugas de líquido, decoloración o deformación de la batería, o cualquier otra anomalía durante la operación, interrumpa el uso de la cámara.
- Si el fluido de la pila entrara en contacto con su ropa o con su piel, quítese la ropa y lave de inmediato la parte afectada con agua corriente fresca y limpia. Si el fluido quemara su piel, solicite atención médica inmediatamente.
- Nunca exponga la pila a fuertes impactos ni a vibraciones continuas.

Es

## Para los clientes de Norte y Sudamérica

### Para los clientes de Estados Unidos

Declaración de conformidad

Número de modelo : FE-110/X-705, FE-100/X-710

Nombre comercial : OLYMPUS

Entidad responsable: **OLYMPUS IMAGING AMERICA INC.**

Dirección : Two Corporate Center Drive, P.O. Box 9058, Melville,  
NY 11747-9058 EE.UU.

Número de teléfono: 1-631-844-5000

Se ha probado su cumplimiento con las normas FCC

PARA USO DOMÉSTICO O COMERCIAL

Este dispositivo cumple con el Apartado 15 de las normas FCC. La operación se encuentra sujeta a las dos condiciones siguientes:

- (1) Este dispositivo podría no causar interferencia perjudicial.
- (2) Este dispositivo debe aceptar cualquier interferencia que se reciba, incluyendo aquellas interferencias que pueden provocar un funcionamiento no deseado.

### Para los clientes de Canadá

Este aparato digital de Clase B cumple con todos los requerimientos de las reglamentaciones canadienses sobre equipos generadores de interferencia.

Es

## Marcas comerciales

- IBM es una marca registrada de International Business Machines Corporation.
- Microsoft y Windows son marcas registradas de Microsoft Corporation.
- Macintosh es una marca comercial de Apple Computer Inc.
- xD-Picture Card™ es una marca comercial.
- Todos los demás nombres de compañías y productos son marcas registradas y/o marcas comerciales de sus respectivos propietarios.
- Las normas para sistemas de archivos de cámara referidas en este manual son las "Normas de Diseño para Sistema de Archivos de Cámara/DCF" estipuladas por la Asociación de Industrias Electrónicas y de Tecnología de Información de Japón (JEITA).

# MEMO

---

[www.DataSheet4U.com](http://www.DataSheet4U.com)

[www.DataSheet4U.com](http://www.DataSheet4U.com)

# Índice

<b>DIAGRAMA DA CÂMARA.....</b>	<b>87</b>
<b>ANTES DE COMEÇAR.....</b>	<b>88</b>
<b>INICIAÇÃO.....</b>	<b>89</b>
Passo 1 INICIAÇÃO.....	89
Passo 2 FOTOGRAFAR.....	90
Passo 3 REVER OU APAGAR UMA FOTOGRAFIA.....	91
Passo 4 TRANSFERIR IMAGENS.....	92
<b>FUNCIONAMENTO BÁSICO.....</b>	<b>94</b>
Dicas para fotografar.....	94
Botão Fotografia e botão Reprodução.....	94
Botões do Modo Fotografia.....	95
Modo Fotografia.....	96
Temporizador.....	96
Modo de Compensação da Exposição.....	97
Modo Macro.....	97
Modos Flash.....	98
Função de poupança de energia.....	98
<b>MENUS E DEFINIÇÕES.....</b>	<b>99</b>
Menu.....	99
Apagar todas as imagens.....	99
Selecionar um idioma.....	100
Símbolos e ícones do ecrã.....	101
Visualização de miniaturas (Índice).....	102
<b>LIGAR A CÂMARA.....</b>	<b>103</b>
Reprodução num televisor.....	103
Impressão directa (PictBridge).....	104
<b>SOFTWARE OLYMPUS Master.....</b>	<b>105</b>
<b>ESPECIFICAÇÕES.....</b>	<b>106</b>
<b>PRECAUÇÕES DE SEGURANÇA.....</b>	<b>108</b>

- Antes de utilizar a câmara, leia este manual atentamente para garantir uma utilização correcta.
- Recomendamos que tire fotografias de teste para se habituar à câmara antes de começar a tirar fotografias importantes.
- Respeite as precauções de segurança apresentadas no final deste manual.
- As imagens do ecrã LCD e as ilustrações da câmara utilizadas neste manual podem diferir do produto real. Neste manual, todas as imagens têm como base o modelo FE-110/X-705.

# DIAGRAMA DA CÂMARA

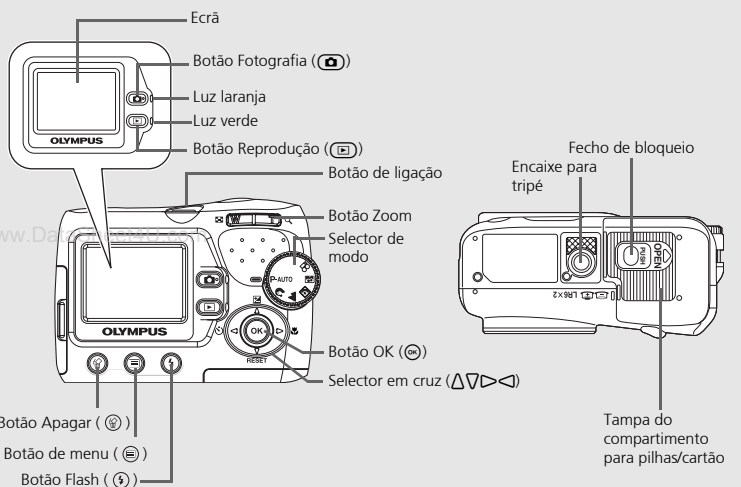
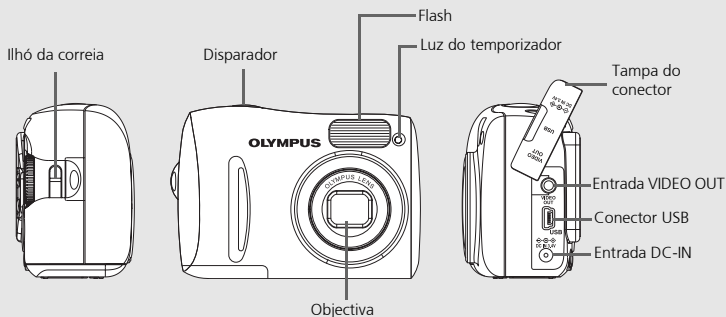

Po

## ANTES DE COMEÇAR

### Reúna estes itens (conteúdo da caixa)



Câmara Digital



Correia

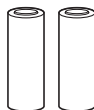

Pilhas AA (R6)  
(duas)



Cabo USB (cinzento-claro)



Cabo de vídeo (preto)



CD-ROM do software  
OLYMPUS Master

Po

Itens não ilustrados: Manual Avançado (CD-ROM), Manual Básico (este manual), Cartão de Garantia. O conteúdo pode variar consoante o local de aquisição.

O xD-Picture Card só é incluído com o modelo FE-110/X-705.



[www.DataSheet4U.com](http://www.DataSheet4U.com)

### Dicas

- A câmara que adquiriu dispõe da sua própria memória interna. Mesmo que não seja inserido um xD-Picture Card, as fotografias serão gravadas na memória interna.

[www.DataSheet4U.com](http://www.DataSheet4U.com)



# 1 INICIAÇÃO

## a. Colocar a correia

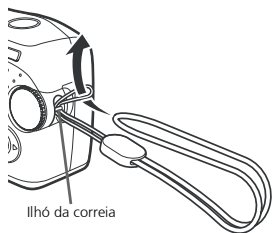

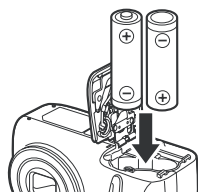
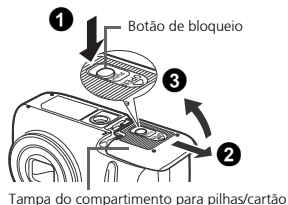

- Puxar bem a correia de modo a que não fique solta.

## b. Inserir as pilhas



## c. Definir a data e hora

[www.DataSheet4U.com](http://www.DataSheet4U.com)

- 1 Rode o selector de modo para **P-AUTO** e prima o botão de ligação para ligar a câmara.
- 2 Premir  para visualizar o ecrã do menu.
- 3 Premir  para definir um item. Premir  para seleccionar o campo seguinte.

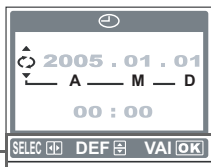
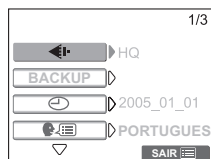

Guia de funcionamento

[www.DataSheet4U.com](http://www.DataSheet4U.com)

Po

# 2 FOTOGRAFAR

## a. Zoom

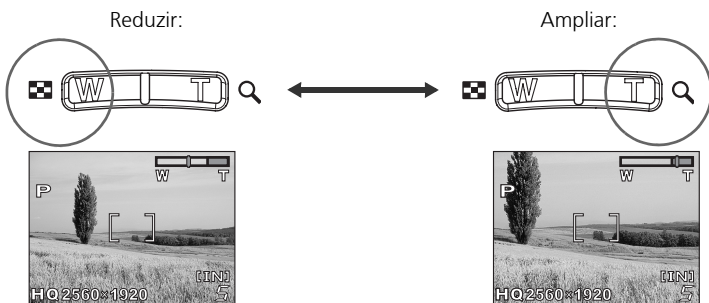

Po

## b. Focar

- 1 Utilizando o ecrã, colocar a marca AF sobre o tema fotográfico.

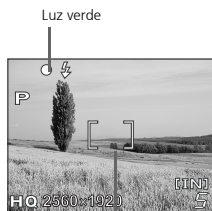

Marca AF

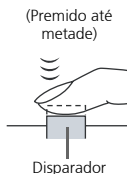

- 2 Premir o disparador até metade e manter nessa posição para bloquear a focagem.
  - A luz verde indica que a focagem está bloqueada.

## c. Fotografar

- 1 Premir totalmente o disparador para fotografar.

(Totalmente premido)

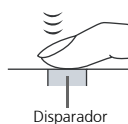

# 3 REVER OU APAGAR UMA FOTOGRAFIA

## a. Premir

- A última imagem fotografada será visualizada.

Botão Reprodução



Botão Zoom

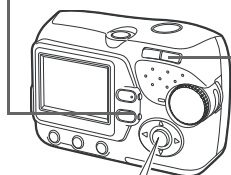





Fotografia anterior

Fotografia seguinte

Selector em cruz

## b. Ver mais de perto



- Prima T (Q) para ampliar a fotografia.
- Prima W (Q) para voltar ao normal.
- Premir   ou   para percorrer a imagem.



Premir  para voltar ao modo fotografia.

Po

## c. Para apagar uma fotografia

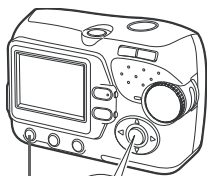

Botão Apagar  
()

Botão OK



- 1 Visualizar a fotografia que pretende apagar.
- 2 Premir .
- 3 Seleccionar [SIM] e premir .
  - A fotografia é eliminada permanentemente.

# 4 TRANSFERIR IMAGENS

## a. Instalar o software

- 1 Inserir o CD-ROM OLYMPUS Master.
- 2 **Windows:** Fazer clique no botão "OLYMPUS Master".  
**Macintosh:** Fazer duplo clique no ícone "Installer".
- 3 Seguir simplesmente as instruções no ecrã.



## b. Ligar a câmara ao computador

- 1 Ligar a câmara ao computador usando o cabo USB (incluído).
  - O ecrã ligar-se-á automaticamente.

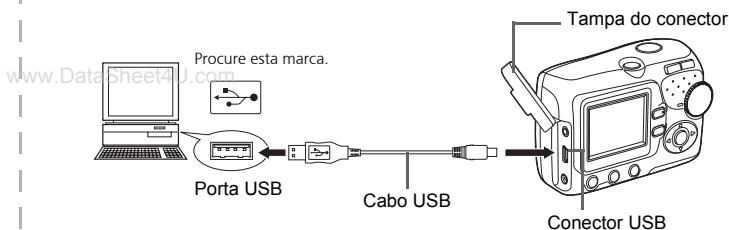

- 2 Seleccionar [PC] no ecrã e premir **OK**.

- O PC reconhece agora a câmara como um disco amovível.

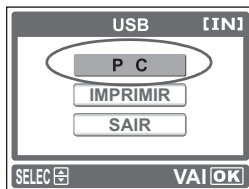

## c. Transferir imagens para o computador

- 1 Com a câmara ligada, abrir o OLYMPUS Master.
  - Surge a janela [Transfer Images] (Transferir imagens).
- 2 Seleccionar as imagens que pretende transferir e fazer clique no botão [Transfer Images] (Transferir imagens).



Botão [Transfer Images] (Transferir imagens)

Se a janela [Transfer Images] (Transferir imagens) não surgir automaticamente:

- a. Fazer clique no ícone "Transfer Images" (Transferir imagens) no menu principal do OLYMPUS Master.
- b. Fazer clique no ícone "From Camera" (Da câmara).



### Dicas

- Para obter informações pormenorizadas relativamente à configuração e utilização da câmara, consultar o "Manual avançado" da câmara fornecido em CD-ROM.
- Para obter informações sobre como utilizar outras funções do software OLYMPUS Master que não tenham sido mencionadas, abrir a "Ajuda" do software OLYMPUS Master ou ler o manual de referência (em formato PDF).

# FUNCIONAMENTO BÁSICO

## Dicas para fotografar

As fotografias podem ficar desfocadas devido à oscilação da câmara quando o disparador é premido.

Para evitar a oscilação da câmara, segurar a câmara com firmeza usando as duas mãos, enquanto mantém os cotovelos junto a si. Manter os dedos e a correia afastados da objectiva e do flash.

Segurar na horizontal

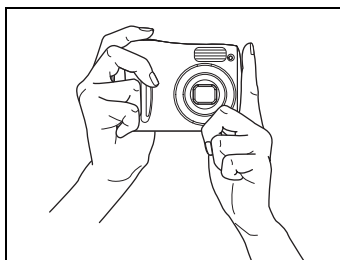

Segurar na vertical

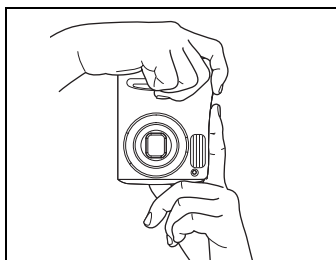

Po

## Botão Fotografia e botão Reprodução

Para tirar fotografias ou efectuar definições de fotografia, seleccione o modo fotografia premindo .

Para visualizar, editar ou eliminar fotografias que tirou, seleccione o modo reprodução premindo .

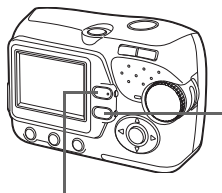

Botão  (Modo Fotografia)

Botão  (Modo Reprodução)

## Botões do Modo Fotografia

No Modo Fotografia, utilize estes botões para obter um acesso rápido a algumas das funções mais frequentemente utilizadas.

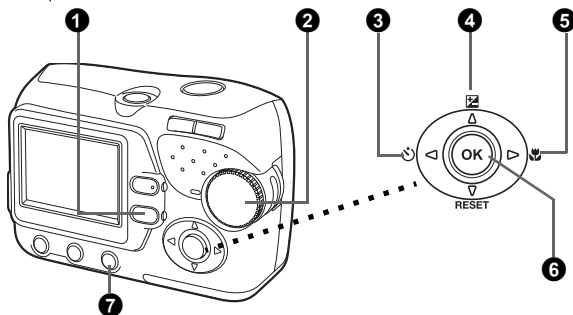

**1 Botão  (Modo Reprodução)**

A câmara muda para o Modo Reprodução.

**2 Selector de modo**

Além do modo predefinido (**P-AUTO**), existem outros modos que possuem melhores definições para as respectivas finalidades e condições de fotografia.

**3 Botão  (Temporizador)**

Selecione o temporizador para atrasar o disparo cerca de 12 segundos a partir do momento em que o disparador é premido.

**4 Botão  (Compensação da exposição)**

Utilize esta definição para aumentar (+) ou diminuir (-) a exposição de uma fotografia.



**5 Botão  (Modo Macro)**

Utilize o Modo Macro ou Super Macro para fotografar grandes planos como, por exemplo, de uma flor.

**6 Botão  (OK)**

Prima para confirmar as definições.

**7 Botão  (Modo Flash)**

Selecione entre 4 modos flash - Automático,  (Redução do efeito de olhos vermelhos),  (Activação forçada) ou  (Flash desligado).

## Modo Fotografia

Rode o selector de modo para seleccionar um modo de fotografia. À medida que roda o selector de modo, surge no ecrã a descrição de cada modo.

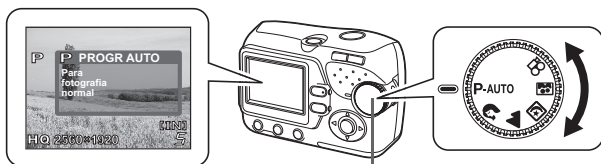

Selector de modo

- **P-AUTO** PROGR AUTO
- **RETRATO**
- **PAISAGEM**
- **CENA NOCT**
- **AUTO-RETRATO**
- **VÍDEO**

## Temporizador

Po

- 1 Premir .
  - Surge no ecrã das definições do temporizador.
- 2 Premir para seleccionar [LIGADO] e premir .
- 3 Premir totalmente o disparador para fotografar.
  - A luz do temporizador acende-se durante aproximadamente 10 segundos depois de o disparador ser premido e depois começa a piscar. Depois de piscar durante aproximadamente 2 segundos, a imagem é fotografada.



Luz temporizador

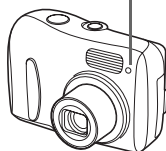



## Modo de Compensação da Exposição

- 1 Premir  $\Delta$  (☒).
  - Surge o ecrã de definição da compensação da exposição.
- 2 Premir  $\triangleleft$   $\triangleright$  para seleccionar o valor da compensação da exposição e premir  $\odot$ .
  - Selecciona um valor [ + ] para clarear a imagem ou um valor [ - ] para escurecer a imagem.
- 3 Fotografar.





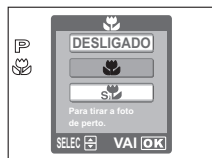

## Modo Macro

- 🌸 Este modo permite-lhe tirar fotografias a uma distância de apenas 20 cm do seu tema fotográfico (Quando o zoom estiver definido para a definição mais ampla).
- 📷 Utilize este modo para tirar fotografias a uma distância de apenas 2 cm do seu tema fotográfico. A posição do zoom está fixada automaticamente e não pode ser alterada.

- 1 Premir  $\triangleright$  (🌸).
  - Surge o ecrã de definição da fotografia Macro.
- 2 Premir  $\Delta$   $\nabla$  para seleccionar o Modo Macro e premir  $\odot$ .
  - Também é possível fazer a definição premindo  $\triangleright$  (🌸) repetidamente.
- 3 Fotografar.



## Modos Flash

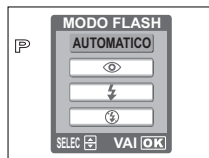

- 1 Premir o botão do Modo Flash (  ).
  - Surge o ecrã de definição do Flash.
- 2 Premir  $\Delta \nabla$  para seleccionar o Modo Flash e premir .
  - Também é possível fazer a definição premindo  repetidamente.
- 3 Premir o disparador até meio.
  - Quando o flash disparar, acende-se  (flash em espera).
- 4 Premir totalmente o disparador para fotografar.



### Alcance fotográfico do flash:



W (máx.): Cerca de 0,2 m a 3,8 m

T (máx.): Cerca de 0,5 m a 2,2 m

Ícone	Modo Flash	Descrição
Sem indicação	Flash automatico	O flash dispara automaticamente em condições de luz fraca ou contraluz.
	Flash de redução do efeito de olhos vermelhos	O modo flash de redução do efeito de olhos vermelhos reduz significativamente este fenómeno, emitindo pré-flashes antes de disparar o flash habitual.
	Activação forçada	O flash dispara independentemente da luz disponível.
	Flash desligado	O flash não dispara mesmo em situações de luz fraca.

[www.DataSheet4U.com](http://www.DataSheet4U.com)



## Função de poupança de energia

- Para poupar energia das pilhas, a câmara entra automaticamente em modo inactivo e deixa de funcionar se não for utilizada durante 30 segundos. O ecrã desliga-se automaticamente. Prima o disparador,  ou , para ligar o ecrã. Pode seleccionar o intervalo de tempo após o qual a câmara entra automaticamente em modo inactivo.
- Se a câmara não for utilizada durante 30 minutos após entrar em modo inactivo, a objectiva é recolhida e a câmara desliga-se automaticamente. Para voltar a utilizar a câmara, ligue-a novamente.

[www.DataSheet4U.com](http://www.DataSheet4U.com)



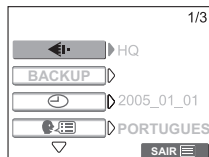

# MENUS E DEFINIÇÕES

## Menu

- 1 Premir  para visualizar os menus da câmara no ecrã.
- 2 Usar o selector em cruz e  para navegar e seleccionar os itens do menu.



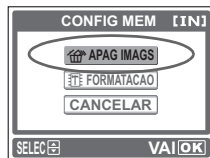

## Apagar todas as imagens

- 1 No Modo Reprodução, seleccionar [CONFIG MEM]\* no menu e premir .  
\*Quando se insere um cartão na câmara, surge a mensagem [CONF CARTAO].
- 2 Premir  para seleccionar [ APAG IMAGS] e premir .



[www.DataSheet4U.com](http://www.DataSheet4U.com)

- 3 Premir  para seleccionar [SIM] e premir .
  - Todas as imagens são apagadas.

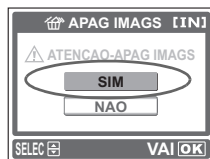



## Seleccionar um idioma

É possível seleccionar um idioma para a visualização no ecrã. Os idiomas disponíveis variam de acordo com a zona onde a câmara foi comprada.

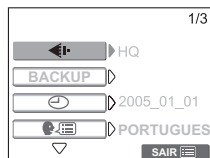

- 1 Premir .
  - Surge o ecrã do menu.



Ecrã do menu

- 2 Prima  para seleccionar .
- O item seleccionado surge a amarelo.



- 3 Premir  ou .

- Po
- 4 Premir  para seleccionar um idioma e premir .



[www.DataSheet4U.com](http://www.DataSheet4U.com)

[www.DataSheet4U.com](http://www.DataSheet4U.com)

## Símbolos e ícones do ecrã

### ● Ecrã – Modo Fotografia



Fotografia parada



Vídeo

	Itens	Indicações
1	Verificação da pilha	= potência total,  = baixa potência
2	Luz verde	= Bloqueio da focagem automático
3	Flash em espera Aviso de oscilação da câmara / Carga do flash	(Aceso) (A piscar)
4	Modo fotografia	, , , , ,
5	Modo Macro Modo super macro	 
6	Modo Flash	, ,
7	Temporizador	
8	Compensação da exposição	-2,0 – +2,0
9	Modo gravação	SHQ, HQ, SQ1, SQ2
10	Tamanho da imagem	<ul style="list-style-type: none"> <li>•FE-110/X-705 2560x1920, 1600x1200, 640x480, 320x240, 160x120</li> <li>•FE-100/X-710 2272x1704, 1600x1200, 640x480, 320x240, 160x120</li> </ul>
11	Marca AF	[ ]
12	Memória em utilização	[IN] (memória interna), [xD] (cartão)
13	Número de imagens paradas graváveis Tempo de gravação disponível	5 00:36

Po

## ● Ecrã – Modo Reprodução

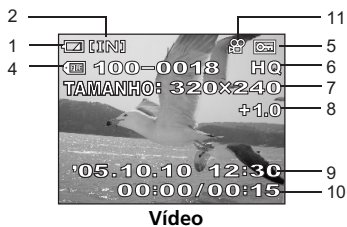
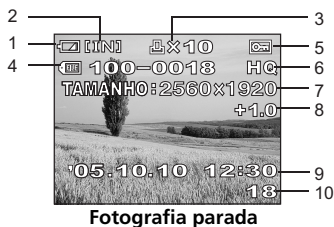

	Itens	Indicações
1	Verificação da pilha	= potência total,  = baixa potência
2	Memória em utilização	[IN] (memória interna), [xD] (cartão)
3	Reserva de impressão / Número de impressões	x10
4	Número de ficheiro	100-0018
5	Proteger	
6	Modo gravação	SHQ, HQ, SQ1, SQ2
7	Tamanho da imagem	<ul style="list-style-type: none"> <li>•FE-110/X-705 2560x1920, 1600x1200, 640x480, 320x240, 160x120</li> <li>•FE-100/X-710 2272x1704, 1600x1200, 640x480, 320x240, 160x120</li> </ul>
8	Compensação da exposição	-2,0 – +2,0
9	Data e hora	'05.10.10 12:30
10	Número de fotografias Tempo decorrido/Tempo de gravação total (vídeo)	18 00:00/0015
11	Vídeo	

## Visualização de miniaturas (Índice)

Esta função permite-lhe visualizar várias imagens em simultâneo no ecrã enquanto revê as imagens.

- 1 Premir o botão Zoom em direcção a W () para mudar para a visualização de miniaturas (Índice).
  - Use o selector em cruz para seleccionar a fotografia e prima para visualizar uma imagem única.
  - Prima T () no botão Zoom para voltar à reprodução de uma imagem única.

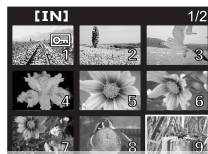

# LIGAR A CÂMARA

## Reprodução num televisor

Utilize o cabo de vídeo fornecido com a câmara para reproduzir as imagens gravadas no seu televisor. É possível reproduzir fotografias e vídeos.

- 1 Assegurar que o televisor e a câmara estão desligados. Ligar a entrada VIDEO OUT da câmara ao terminal de entrada de vídeo do televisor utilizando o cabo de vídeo.

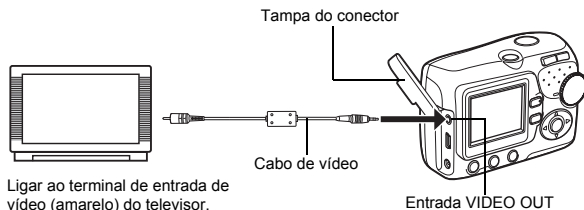

- 2 Ligar o televisor e colocá-lo no modo de entrada de vídeo.
  - Para obter informações sobre como mudar para a entrada de vídeo, consultar o manual de instruções do televisor.
- 3 Prima o botão de ligação para ligar a câmara e prima .
  - A última imagem fotografada é visualizada no televisor. Use o selector em cruz para seleccionar a imagem que pretende visualizar.

[www.DataSheet4U.com](http://www.DataSheet4U.com)

## Impressão directa (PictBridge)

Usando o cabo USB fornecido, pode ligar a sua câmara directamente a uma impressora compatível com PictBridge, como a Olympus P-11, para imprimir as fotografias.

- 1 Ligar uma extremidade do cabo USB fornecido ao conector USB da câmara e a outra extremidade ao conector USB da impressora.

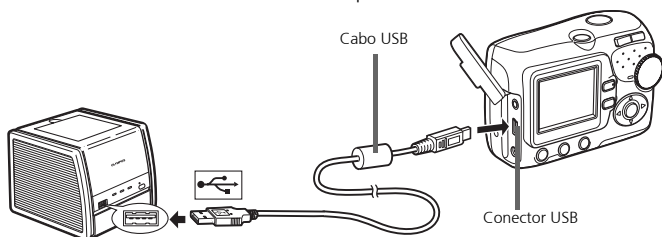

- 2 Premir  $\Delta$ / $\nabla$  para seleccionar [IMPRIMIR] e premir  $\odot$ .

- Enquanto a câmara estiver ligada a uma impressora, a luz verde da câmara permanece acesa.
- Surge UM MOMENTO e a câmara e a impressora são ligadas. Surge no ecrã o ecrã SEL.MD.IMP.

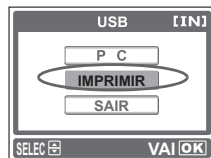

- 3 Use o selector em cruz para seleccionar fotografias e imprimi-las.

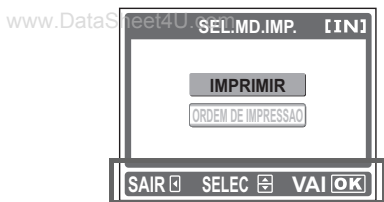

Siga o guia de funcionamento aqui indicado.



# SOFTWARE OLYMPUS Master

Software OLYMPUS Master: Utilize este software para transferir imagens da câmara, visualizar, organizar, retocar, enviar por correio electrónico e imprimir as suas imagens e vídeos digitais e muito mais! Este CD também contém o manual de referência do software completo em formato Adobe Acrobat (PDF).



## ● Requisitos do sistema

SO	Windows 98SE/Me/2000 Professional/XP ou Mac OS X (10.2 ou posterior)
CPU	Pentium III a 500MHz/Power PC G3 ou superior
RAM	128 MB ou mais (256 MB ou mais recomendados)
Disco rígido	300 MB ou mais de espaço disponível em disco
Ligação	Porta USB
Ecrã	1024 x 768 pixels ou mais de resolução com um mínimo de 65.536 (Windows)/32.000 (Macintosh) cores

Para obter as informações mais recentes sobre assistência, visite a página da Web da Olympus (<http://www.olympus.com/digital>)

## ● Actualização (OLYMPUS Master Plus)

Além das funções do OLYMPUS Master, o OLYMPUS Master Plus inclui as funções de edição de vídeo, impressão de álbuns, impressão de folhas de contacto, álbum HTML, panorama sem colagem, gravação de CD/DVD e muito mais, o que lhe permite expandir imensamente as suas capacidades em termos de fotografia digital. É necessário ter o OLYMPUS Master instalado num computador com ligação à Internet.



### Registo do utilizador

Quando instalar o OLYMPUS Master, registe a sua câmara para activar a garantia, receber avisos sobre actualizações de software e do firmware da câmara e muito mais.

# ESPECIFICAÇÕES

## Câmara

Tipo de produto	: Câmara Digital (para fotografar e visualizar)
Sistema de gravação	
Fotografia parada	: Gravação Digital, JPEG (de acordo com a Norma de concepção para sistemas de ficheiros de câmaras (DCF))
Normas aplicáveis	: Exif 2.2, Digital Print Order Format (DPOF), PRINT Image Matching III, PictBridge
Vídeo	: Suporte de QuickTime Motion JPEG
Memória	: Memória interna, xD-Picture Card (16 MB – 1 GB)

N.º de imagens graváveis • Quando é utilizada a memória interna.

FE-110/X-705	FE-100/X-710
7 imagens (SH:2560 x 1920)	9 imagens (SH:2272 x 1704)
22 imagens (HQ:2560 x 1920)	28 imagens (HQ:2272 x 1704)
42 imagens (SQ1:1600 x 1200)	42 imagens (SQ1:1600 x 1200)
160 imagens (SQ2:640 x 480)	160 imagens (SQ2:640 x 480)

• Quando é utilizado um xD-Picture Card de 16 MB.

FE-110/X-705	FE-100/X-710
4 imagens (SH:2560 x 1920)	5 imagens (SH:2272 x 1704)
12 imagens (HQ:2560 x 1920)	16 imagens (HQ:2272 x 1704)
24 imagens (SQ1:1600 x 1200)	24 imagens (SQ1:1600 x 1200)
91 imagens (SQ2:640 x 480)	91 imagens (SQ2:640 x 480)

N.º de píxeis efectivos	: 5.000.000 píxeis (FE-110/X-705) : 4.000.000 píxeis (FE-100/X-710)
Dispositivo de captação de imagens	: CCD de 1/2,5" de captação de imagem em estado sólido, 5.360.000 píxeis (brutos) (FE-110/X-705), 4.230.000 píxeis (brutos) (FE-100/X-710)
Objectiva	: Objectiva Olympus de 6,2 mm a 17,4 mm, f3,0 a 5,0 (equivalente a uma objectiva de 38 mm a 106 mm numa câmara de 35 mm)
Sistema fotométrico	: Medição ponderada ao centro
Velocidade obturador	: 1 a 1/2000 seg. (modo CENA NOCT: 2 seg.)
Amplitude de focagem	: 0,5 m a $\infty$ (W), 0,9 m a $\infty$ (T) (normal) 0,2 m a 0,5m (W), 0,5 m a 0,9 m (T) (Modo Macro)
Ecrã	: Visor LCD a cores de 1,5" TFT, 130.000 píxeis
Conector exterior	: Entrada DC-IN, conector USB (mini-B), Entrada VIDEO-OUT

Sistema de calendário automático	: 2005 até 2099
Ambiente de funcionamento	
Temperatura	: 0°C a 40°C (32°F a 104°F) (funcionamento)/-20°C a 60°C (-4°F a 140°F) (armazenamento)
Humidade	: 30% a 90% (funcionamento)/10% a 90% (armazenamento)
Alimentação	: Duas pilhas oxyride, duas pilhas alcalinas ou duas pilhas de NiMH, R6 (tamanho AA)/adaptador de CA Olympus (opcional)
Dimensões	: 87,5 mm (L) × 62,5 mm (A) × 38,5 mm (P) excluindo saliências
Peso	: 140 g sem pilhas e cartão

### **xD-Picture Card**

Tipo de memória	: EEPROM do flash NAND
Ambiente de funcionamento	
Temperatura	: 0°C a 55°C (funcionamento)/-20°C a 65°C (armazenamento)
Humidade	: 95% ou inferior
Potência	: 3 V (3,3 V)
Dimensões	: 20 × 25 × 1,7 mm

O design e as especificações estão sujeitas a alterações sem aviso previo.

# PRECAUÇÕES DE SEGURANÇA



## CUIDADO

NÃO ABRIR, PERIGO DE  
CHOQUE ELÉCTRICO



**CUIDADO:** PARA REDUZIR O RISCO DE CHOQUE ELÉCTRICO, NÃO RETIRE A TAMPA (OU COSTAS), NÃO TOQUE NAS PARTES INTERNAS CONTACTE OS SERVIÇOS TÉCNICOS QUALIFICADOS DA OLYMPUS.



O ponto de exclamação dentro de um triângulo, alerta o utilizador da presença de partes importantes para o funcionamento e de manutenção (serviços técnicos). Ver as instruções que acompanham este produto.



### PERIGO

Se o produto for utilizado sem observar a informação subjacente a este símbolo, poderão resultar lesões graves ou morte.



### ADVERTÊNCIA

Se o produto for utilizado sem observar a informação subjacente a este símbolo, poderão resultar lesões ou morte.



### PRECAUÇÃO

Se o produto for utilizado sem observar a informação subjacente a este símbolo, poderão resultar lesões pessoais, danos no equipamento ou a perda de dados importantes.

#### ATENÇÃO!

PARA REDUZIR O RISCO DE FOGO OU DE CHOQUES ELECTRICOS, NÃO EXPONHA ESTE EQUIPAMENTO À CHUVA, EM CONTACTO COM LÍQUIDOS OU EM LOCAIS COM HUMIDADE.

Po

## Precauções Gerais

**Leia todas as instruções** — Antes de utilizar o produto, leia todas as instruções de funcionamento. Guarde todos os manuais e instruções de segurança para futuras consultas.

**Limpeza** — Desligue sempre da tomada, antes de o limpar. Utilize apenas um pano macio para limpeza. Nunca use para limpar nenhum tipo de líquido ou aerossol, ou solvente orgânico.

**Acessórios** — Para sua segurança e evitar danos no produto, utilize apenas acessórios recomendados pela Olympus.

**Água e Humidade** — Para consultar as precauções sobre os produtos com características à prova de água, leia as respectivas secções.

**Localização** — Para evitar danos no produto, monte-o com segurança sobre um tripé, estante ou suporte estável.

**Fonte de energia** — Ligue este aparelho à fonte de energia designa para ele.

**Relâmpagos** — Se houver uma tempestade durante a utilização de um adaptador CA, desligue-o imediatamente da tomada da parede.

**Objectos estranhos** — Para evitar lesões pessoais, nunca insira objectos metálicos dentro do produto.

**Calor** — Nunca use ou guarde este produto perto de uma fonte de calor, tais como, radiador, aquecedor, ou qualquer tipo de equipamento ou ferramentas que produza calor, incluindo amplificadores de som.

## Manuseamento da Câmara



### ADVERTÊNCIA

- **Não utilize a câmara perto de gases inflamáveis ou explosivos.**
- **Não utilize o flash a curta distância das pessoas (especialmente crianças, adolescentes, etc.).**
  - Deverá manter-se a uma distância de no mínimo 1 m das faces dos seus sujeitos. Se disparar o flash muito próximo dos olhos do sujeito pode causar uma perda momentânea da visão.
- **Mantenha as crianças e adolescentes fora do alcance da câmara.**
  - Utilize e guarde sempre a câmara fora do alcance das crianças e menores, para prevenir as seguintes situações de perigo que poderiam causar sérias lesões:
    - Ficar preso na correia da câmara, ocasionando asfixia.
    - Ingerir acidentalmente uma pilha ou uma pequena peça.
    - Disparar o flash acidentalmente sobre os seus próprios olhos ou sobre os olhos de outra criança.
    - Lesionar-se acidentalmente com as peças móveis da câmara.
- **Não olhe para o sol ou para luzes fortes através da câmara.**
- **Não deixar nem guarde a câmara em locais com pó ou humidade.**
- **Durante o disparo, não obstrua o flash com a mão.**



### PRECAUÇÃO

- **Interrompa imediatamente a utilização da câmara se notar algum cheiro, ruído ou fumo estranho a sair.**
  - Nunca remova as pilhas com as mãos desprotegidas, pois pode provocar incêndio ou queimar as suas mãos.
- **Nunca segure nem opere a câmara com as mãos molhadas.**
- **Não deixar a câmara em locais onde possa estar sujeita a elevadas temperaturas.**
  - Caso contrário, as peças da câmara podem deteriorar-se e, em algumas circunstâncias, provocar incêndio na câmara. Não usar o carregador ou o adaptador de CA se estiver coberto (como com um cobertor). Caso contrário, pode provocar sobreaquecimento ou fogo.
- **Manusear a câmara com cuidado de modo a evitar uma queimadura provocada por baixas temperaturas.**
  - Quando a câmara contém peças metálicas, pode ocorrer o sobre-aquecimento das mesmas, resultando em queimaduras de baixa temperatura. Ter em atenção o seguinte:
    - Quando usada durante um longo período, a câmara ficará quente. Se continuar a segurar a câmara nesta condição, pode ocorrer uma queimadura de baixa temperatura.

- Em locais sujeitos a temperaturas extremamente frias, a temperatura do corpo da câmara pode ser inferior à temperatura ambiente. Se possível, usar luvas ao manusear a câmara a baixas temperaturas.

### ● Tenha cuidado com a correia.

- Quando transportar a câmara tenha cuidado com a correia, já que, é fácil enlaçar em objectos soltos e causar sérios danos.

## Precauções a respeito da manipulação das pilhas

**Siga estas importantes indicações para evitar que ocorram fugas de líquido, sobre-aquecimento, incêndio ou explosão das pilhas ou para evitar choques eléctricos ou queimaduras.**



### PERIGO

- Utilize somente as pilhas NiMH e o carregador apropriado de marca Olympus.
- Nunca aqueça ou queime as pilhas.
- Tome precauções ao transportar ou guardar as pilhas a fim de evitar que entrem em contacto com objectos metálicos, tais como agramos, ganchos, jóias, etc.
- Nunca guarde as pilhas em lugares onde fiquem expostas a luz solar directa ou sujeitas a altas temperaturas ou no interior de um veículo com aquecimento, perto de uma fonte de calor, etc.
- Para evitar que ocorram fugas de líquido das pilhas ou danos dos seus terminais, siga cuidadosamente todas as instruções respectivas ao uso das pilhas. Nunca tente desmanchar a pilha nem modifica-la de nenhuma maneira, por soldadura, etc.
- Se o líquido da pilha penetrar nos seus olhos, lave-os de imediato com água corrente fresca e limpa, e procure assistência médica imediatamente.
- Guarde as pilhas sempre fora do alcance das crianças menores. Se um menor ingerir uma pilha acidentalmente, procure assistência médica imediatamente.



### ADVERTÊNCIA

- Mantenha as pilhas sempre secas.
- Para evitar que ocorram fugas de líquido, sobre-aquecimento ou que provoquem incêndio ou explosão, utilize exclusivamente as pilhas recomendadas para este produto.
- Nunca misture as pilhas (novas com usadas, carregadas com descarregadas, de diferentes marcas ou capacidade, etc.).
- Nunca tente recarregar pilhas alcalinas, de lítio ou as pilhas de lítio CR-V3.
- Insira a pilha cuidadosamente conforme descrito no manual de instruções.
- Não utilize pilhas que não estão revestidas com protecção isolante ou que estão com a protecção danificada, visto que poderá ocorrer vazamento de líquido, provocar incêndio ou lesões.

## PRECAUÇÃO

- Não remova as pilhas logo após desligar a câmara. As pilhas podem ficar quentes durante o uso prolongado.
- Remova a pilha da câmara sempre que for guardar a câmara por um período prolongado.

- As seguintes pilhas tipo AA (R6) não podem ser utilizadas.

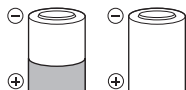

Pilhas parcialmente cobertas ou sem a cobertura da protecção isoladora.



Pilhas com os terminais  $\ominus$  em relevo, mas sem a protecção isoladora.

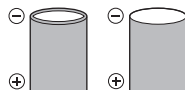

Pilhas com os terminais rasos, mas não completamente cobertos pela protecção isoladora. (Tais pilhas não podem ser utilizadas mesmo que os terminais  $\ominus$  estejam parcialmente cobertos.)

- Se as pilhas de NiMH não recarregarem dentro do tempo especificado, interrompa a recarga e não as utilize.
- Não usar uma pilha se estiver rachada ou partida.
- Se ocorrer um vazamento, descoloração ou deformação da pilha, ou qualquer outra anormalidade durante a operação, interrompa o uso da câmara.
- Se o líquido da pilha entrar em contacto com a roupa ou a pele, retire a roupa e lave de imediato a parte afectada com água corrente fresca e limpa. Se o líquido queimar a pele, solicite imediatamente cuidados médicos.
- Nunca exponha as pilhas a fortes impactos nem a vibrações contínuas.

Po

## Para Clientes na América do Norte e do Sul

### Para Clientes nos EUA

Declaração de Conformidade

Modelo Número : FE-110/X-705, FE-100/X-710

Nome Comercial : OLYMPUS

Parceiro Responsável: **OLYMPUS IMAGING AMERICA INC.**

Morada : Two Corporate Center Drive, P.O. Box 9058, Melville, NY  
11747-9058 EUA.

Telefone Número:1-631-844-5000

Testada Em Conformidade Com O Standard FCC

PARA USO DOMÉSTICO OU NO ESCRITÓRIO

Este aparelho está em conformidade com a Capítulo 15 das Regras FCC. O seu funcionamento está sujeito a duas condições:

- (1) Este aparelho não pode causar perigo de interferência.
- (2) Este aparelho pode receber qualquer tipo de interferência, inclusive interferências que possam originar o seu mau funcionamento.

### Para Clientes no Canadá

Este aparelho digital da Classe B está em conformidade com a Regulamentação Canadiana para Equipamentos Causadores de Interferências.

## Marcas Comerciais

- A IBM é uma marca comercial registada da International Business Machines Corporation.
- Microsoft e Windows são marcas comerciais registadas da Microsoft Corporation.
- Macintosh é uma marca comercial registada da Apple Computers Inc.
- xD-Picture Card™ é uma marca registada.
- Todas as outras companhias e nomes de produtos são marcas comerciais registadas e/ou marcas comerciais dos respectivos fabricantes.
- Os standards referidos neste manual para os sistemas de ficheiro da câmara são os standards DCF (“Design Rule for Camera File System”) estipulados pela JEITA (“Japan Electronics and Information Technology Industries Association”).

Po



# MEMO

---

[www.DataSheet4U.com](http://www.DataSheet4U.com)

# MEMO

---

[www.DataSheet4U.com](http://www.DataSheet4U.com)

[www.DataSheet4U.com](http://www.DataSheet4U.com)

# MEMO

---

[www.DataSheet4U.com](http://www.DataSheet4U.com)

# OLYMPUS®

<http://www.olympus.com/>

## OLYMPUS IMAGING CORP.

Shinjuku Monolith, 3-1 Nishi-Shinjuku 2-chome, Shinjuku-ku, Tokyo, Japan

## OLYMPUS IMAGING AMERICA INC.

Two Corporate Center Drive, P.O. Box 9058, Melville, NY 11747-9058, U.S.A. Tel. 631-844-5000

### Technical Support (USA)

24/7 online automated help: <http://www.olympusamerica.com/support>

Phone customer support: Tel. 1-888-553-4448 (Toll-free)

Our phone customer support is available from 8 am to 10 pm

(Monday to Friday) ET

E-Mail: [distec@olympus.com](mailto:distec@olympus.com)

Olympus software updates can be obtained at: <http://www.olympus.com/digital>

## OLYMPUS IMAGING EUROPA GMBH

Premises: Wendenstrasse 14-18, 20097 Hamburg, Germany

Tel: +49 40-23 77 3-0 / Fax: +49 40-23 07 61

Goods delivery: Bredowstrasse 20, 22113 Hamburg, Germany

Letters: Postfach 10 49 08, 20034 Hamburg, Germany

### European Technical Customer Support:

Please visit our homepage <http://www.olympus-europa.com>

or call our TOLL FREE NUMBER\* : **00800 - 67 10 83 00**

for Austria, Belgium, Denmark, Finland, France, Germany, Italy, Luxemburg, Netherlands,  
Norway, Portugal, Spain, Sweden, Switzerland, United Kingdom

\* Please note some (mobile) phone services/provider do not permit access or request an additional prefix to +800 numbers.

For all not listed European Countries and in case that you can't get connected to the above mentioned number please make use of the following

CHARGED NUMBERS: **+49 180 5 - 67 10 83** or **+49 40 - 237 73 899**

Our Technical Customer Support is available from 9 am to 6 pm MET (Monday to Friday)