

FGC4000BX-90DS

HIGH POWER INVERTER USE
PRESS PACK TYPE

FGC4000BX-90DS



- ITQRM Repetitive controllable on-state current 4000A
- IT(AV) Average on-state current 1200A
- VDRM Repetitive peak off state voltage 4500V
- Anode short type

OUTLINE DRAWING

Dimensions in mm

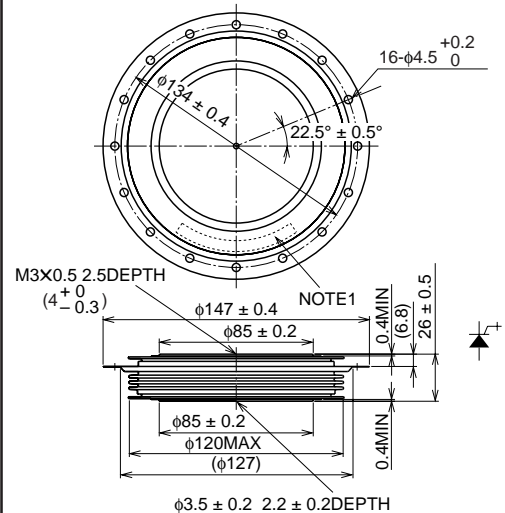

APPLICATION

Inverters, DC choppers, Induction heaters, DC to DC converters.

MAXIMUM RATINGS

Symbol	Parameter	Voltage class		Unit
		90DS		
VRRM	Repetitive peak reverse voltage	21		V
VRSM	Non-repetitive peak reverse voltage	21		V
VR(DC)	DC reverse voltage	21		V
VDRM	Repetitive peak off-state voltage*	4500		V
VDSM	Non-repetitive peak off-state voltage*	4500		V
VD(DC)	DC off-state voltage*	3600		V
VLDS	Long term DC stability voltage*	3000		V

* : V_{GK} = -2V

Symbol	Parameter	Conditions	Ratings	Unit
ITQRM	Repetitive controllable on-state current	(Snubberless) VDM = 4500V, VD = 2250V, LC = 0.2μH, VRG = 21V diG/dt = 6000A/μs. Tj = 25/125°C	4000	A
IT(RMS)	RMS on-state current	Applied for all conduction angles	1880	A
IT(AV)	Average on-state current	f = 60Hz, sinewave θ = 180°, Tf = 70°C	1200	A
ITSM	Surge on-state current	One half cycle at 60Hz, Tj = 125°C	25	kA
I ² t	Current-squared, time integration		2.6 × 10 ⁶	A ² s
diT/dt	Critical rate of rise of on-state current	VD = 2250V, ITM = 4000A, IGM = 200A, Tj = 125°C diG/dt = 100A/μs (Snubberless)	1000	A/μs
VFGM	Peak forward gate voltage		10	V
VRGM	Peak reverse gate voltage		21	V
IFGM	Peak forward gate current		1000	A
IRGM	Peak reverse gate current		4000	A
PFGM	Peak forward gate power dissipation		10	kW
PRGM	Peak reverse gate power dissipation		120	kW
PFG(AV)	Average forward gate power dissipation		200	W
PRG(AV)	Average reverse gate power dissipation		6300	W
Tj	Junction temperature		-20 ~ +125	°C
T _{stg}	Storage temperature		-20 ~ +150	°C
—	Mounting force required	(Recommended value 40kN)	32 ~ 48	kN
—	Weight	Typical value	1500	g

FGC4000BX-90DS

HIGH POWER INVERTER USE
PRESS PACK TYPE

ELECTRICAL CHARACTERISTICS

Symbol	Parameter	Test conditions	Limits			Unit
			Min	Typ	Max	
V _{TM}	On-state voltage	I _T = 4000A, T _j = 125 C	—	—	4.0	V
I _{RRM}	Repetitive peak reverse current	V _{RM} = 21V, T _j = 125 C	—	—	100	mA
I _{DRM}	Repetitive peak off-state current	V _{DM} = 4500V, V _{GK} = -2V, T _j = 125 C	—	—	150	mA
I _{GRM}	Reverse gate current	V _{RG} = 21V, T _j = 125 C	—	—	100	mA
dv/dt	Critical rate of rise of off-state voltage	V _D = 2250V, T _j = 125 C, V _{GK} = -2V (Expo. ware) (see Fig. 3)	3000	—	—	V/μs
t _d	Turn-on delay	I _T = 4000A, V _D = 2250V, I _{GM} = 200A, T _j = 125 C di/dt = 1000A/μs, di _G /dt = 100A/μs (Snubberless) (see Fig. 1)	—	—	3	ns
t _s	Storage time	(Snubberless) I _T = 4000A, V _{DM} = 4500V, V _D = 2250V di _{GQ} /dt = 6000A/μs, C _c = 6 nF, L _c = 0.2nH V _{RG} = 21V, T _j = 125 C (see Fig. 2)	—	—	3	ns
I _{GQ}	Peak gate turn-off current	DC METHOD : V _D = 24V, R _L = 0.1W, T _j = 25 C	—	—	—	A
I _{GT}	Gate trigger current		—	—	4.0	A
V _{GT}	Gate trigger voltage		—	—	1.5	V
R _{th(j-f)}	Thermal resistance	Junction to fin	—	—	0.011	C/W

Fig.1 TURN-ON SWITCHING WAVEFORM AND TEST CIRCUIT

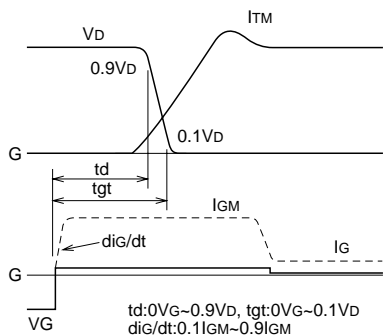

(1) TURN-ON SWITCHING WAVEFORM

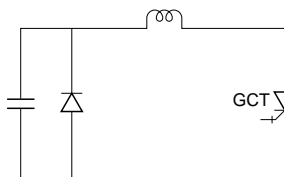

(2) TURN-ON TEST CIRCUIT

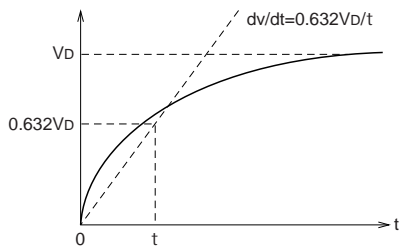
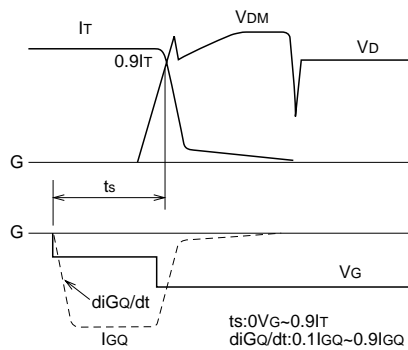
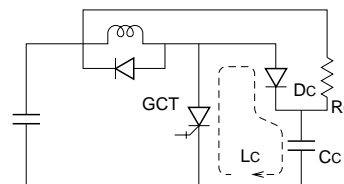

Fig.3 dv/dt TEST WAVEFORM

Fig.1 TURN-OFF SWITCHING WAVEFORM AND TEST CIRCUIT



(1) TURN-OFF SWITCHING WAVEFORM



(2) TURN-OFF TEST CIRCUIT

FGC4000BX-90DS

HIGH POWER INVERTER USE
PRESS PACK TYPE

PERFORMANCE CURVES

MAXIMUM ON-STATE CHARACTERISTIC

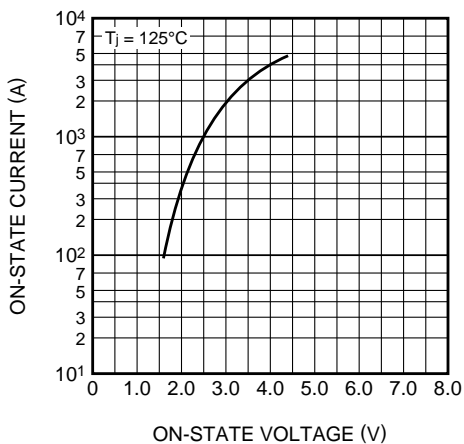

RATED SURGE ON-STATE CURRENT

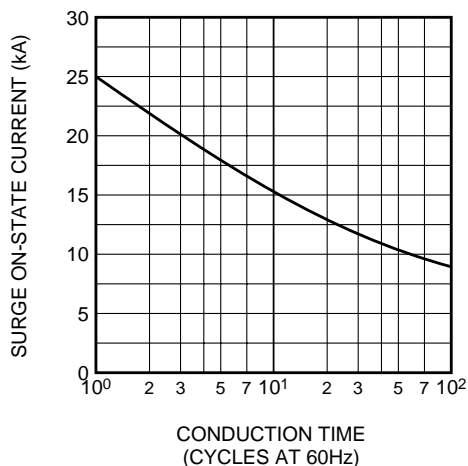

GATE CHARACTERISTICS

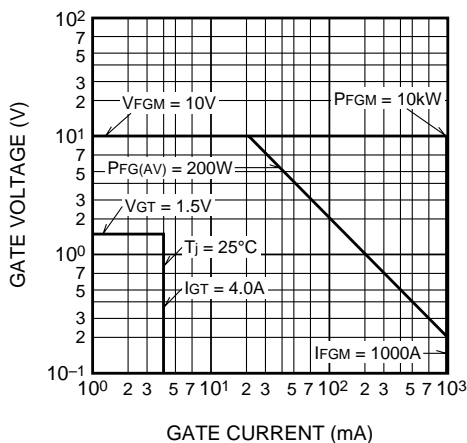

MAXIMUM THERMAL IMPEDANCE CHARACTERISTIC (JUNCTION TO FIN)

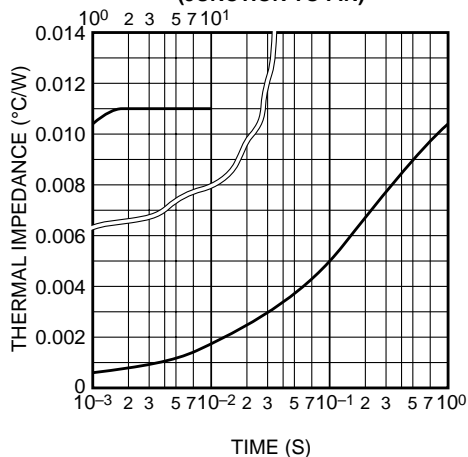

MAXIMUM ON-STATE POWER DISSIPATION CHARACTERISTICS (SINGLE-PHASE HALF WAVE)

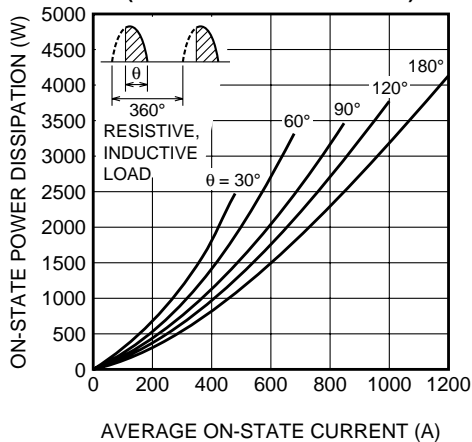

ALLOWABLE FIN TEMPERATURE VS. AVERAGE ON-STATE CURRENT (SINGLE-PHASE HALF WAVE)

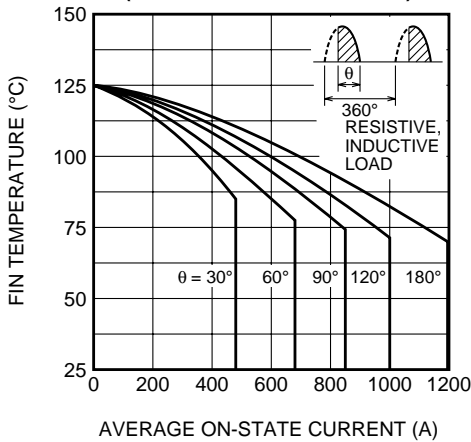

FGC4000BX-90DS

HIGH POWER INVERTER USE
PRESS PACK TYPE

