

FGD3N60LSD IGBT

Features

- High Current Capability
- Very Low Saturation Voltage : $V_{CE(sat)} = 1.2\text{ V @ } I_C = 3\text{ A}$
- High Input Impedance

Applications

- HID Lamp Applications
- Piezo Fuel Injection Applications

Description

Fairchild's Insulated Gate Bipolar Transistors (IGBTs) provide very low conduction losses. The device is designed for applications where very low On-Voltage Drop is a required feature.

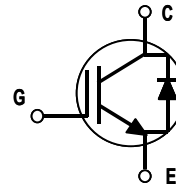
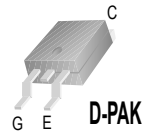

Absolute Maximum Ratings

Symbol	Description	FGD3N60LSD	Units
V_{CES}	Collector-Emitter Voltage	600	V
V_{GES}	Gate-Emitter Voltage	± 25	V
I_C	Collector Current @ $T_C = 25^\circ\text{C}$	6	A
	Collector Current @ $T_C = 100^\circ\text{C}$	3	A
$I_{CM(1)}$	Pulsed Collector Current (1)	25	A
I_F	Diode Continuous Forward Current @ $T_C = 100^\circ\text{C}$	3	A
I_{FM}	Diode Maximum Forward Current	25	A
P_D	Maximum Power Dissipation @ $T_C = 25^\circ\text{C}$	40	W
	Derating Factor	0.32	W/°C
T_J	Operating Junction Temperature	-55 to +150	°C
T_{stg}	Storage Temperature Range	-55 to +150	°C
T_L	Maximum Lead Temp. for Soldering Purposes, 1/8" from Case for 5 Seconds	250	°C

Notes :

(1) Repetitive rating : Pulse width limited by max. junction temperature

Thermal Characteristics

Symbol	Parameter	Typ.	Max.	Units
$R_{\theta JC}$ (IGBT)	Thermal Resistance, Junction-to-Case	--	3.1	°C/W
$R_{\theta JA}$	Thermal Resistance, Junction-to-Ambient (PCB Mount) (2)	--	100	°C/W

Notes :

(2) Mounted on 1" square PCB (FR4 or G-10 Material)

Package Marking and Ordering Information

Device Marking	Device	Package	Reel Size	Tape Width	Quantity
FGD3N60LSD	FGD3N60LSDTM	D-PAK	380mm	16mm	2500

Electrical Characteristics of the IGBT T_C = 25°C unless otherwise noted

Symbol	Parameter	Test Conditions	Min.	Typ.	Max.	Units
Off Characteristics						
BV_{CES}	Collector-Emitter Breakdown Voltage	$V_{GE} = 0V, I_C = 250\mu A$	600	--	--	V
$\frac{\Delta BV_{CES}}{\Delta T_J}$	Temperature Coefficient of Breakdown Voltage	$V_{GE} = 0V, I_C = 1mA$	--	0.6	--	V/°C
I_{CES}	Collector Cut-Off Current	$V_{CE} = V_{CES}, V_{GE} = 0V$	--	--	250	μA
I_{GES}	G-E Leakage Current	$V_{GE} = V_{GES}, V_{CE} = 0V$	--	--	± 100	nA
On Characteristics						
$V_{GE(th)}$	G-E Threshold Voltage	$I_C = 3mA, V_{CE} = V_{GE}$	2.5	3.2	5.0	V
$V_{CE(sat)}$	Collector to Emitter Saturation Voltage	$I_C = 3A, V_{GE} = 10V$	--	1.2	1.5	V
		$I_C = 6A, V_{GE} = 10V$	--	1.8	--	V
Dynamic Characteristics						
C_{ies}	Input Capacitance	$V_{CE} = 25V, V_{GE} = 0V,$ $f = 1MHz$	--	185	--	pF
C_{oes}	Output Capacitance		--	20	--	pF
C_{res}	Reverse Transfer Capacitance		--	5.5	--	pF
Switching Characteristics						
$t_{d(on)}$	Turn-On Delay Time	$V_{CC} = 480V, I_C = 3A,$ $R_G = 470\Omega, V_{GE} = 10V,$ Inductive Load, $T_C = 25^\circ C$	--	40	--	ns
t_r	Rise Time		--	40	--	ns
$t_{d(off)}$	Turn-Off Delay Time		--	600	--	ns
t_f	Fall Time		--	600	--	ns
E_{on}	Turn-On Switching Loss		--	250	--	μJ
E_{off}	Turn-Off Switching Loss	--	1.00	--	mJ	
E_{ts}	Total Switching Loss	--	1.25	--	mJ	
$t_{d(on)}$	Turn-On Delay Time	$V_{CC} = 480V, I_C = 3A,$ $R_G = 470\Omega, V_{GE} = 10V,$ Inductive Load, $T_C = 125^\circ C$	--	40	--	ns
t_r	Rise Time		--	45	--	ns
$t_{d(off)}$	Turn-Off Delay Time		--	620	--	ns
t_f	Fall Time		--	800	--	ns
E_{on}	Turn-On Switching Loss		--	300	--	μJ
E_{off}	Turn-Off Switching Loss	--	1.9	--	mJ	
E_{ts}	Total Switching Loss	--	2.2	--	mJ	
Q_g	Total Gate Charge	$V_{CE} = 480V, I_C = 3A,$ $V_{GE} = 10V$	--	12.5	--	nC
Q_{ge}	Gate-Emitter Charge		--	2.8	--	nC
Q_{gc}	Gate-Collector Charge		--	4.9	--	nC
L_e	Internal Emitter Inductance	Measured 5mm from PKG	--	7.5	--	nH

Electrical Characteristics of DIODE $T_C = 25^\circ\text{C}$ unless otherwise noted

Symbol	Parameter	Test Conditions	Min.	Typ.	Max.	Units	
V_{FM}	Diode Forward Voltage	$I_F = 3\text{A}$	$T_C = 25^\circ\text{C}$	--	1.5	1.9	V
			$T_C = 100^\circ\text{C}$	--	1.55	--	
t_{rr}	Diode Reverse Recovery Time	$I_F = 3\text{A}$, $di/dt = 100\text{A}/\mu\text{s}$ $V_R = 200\text{V}$	$T_C = 25^\circ\text{C}$	--	234	--	ns
			$T_C = 100^\circ\text{C}$	--	--	--	
I_{rr}	Diode Peak Reverse Recovery Current	$I_F = 3\text{A}$, $di/dt = 100\text{A}/\mu\text{s}$ $V_R = 200\text{V}$	$T_C = 25^\circ\text{C}$	--	2.64	--	A
			$T_C = 100^\circ\text{C}$	--	--	--	
Q_{rr}	Diode Reverse Recovery Charge	$I_F = 3\text{A}$, $di/dt = 100\text{A}/\mu\text{s}$ $V_R = 200\text{V}$	$T_C = 25^\circ\text{C}$	--	309	--	nC
			$T_C = 100^\circ\text{C}$	--	--	--	

Typical Performance Characteristics

Figure 1. Typical Output Characteristics

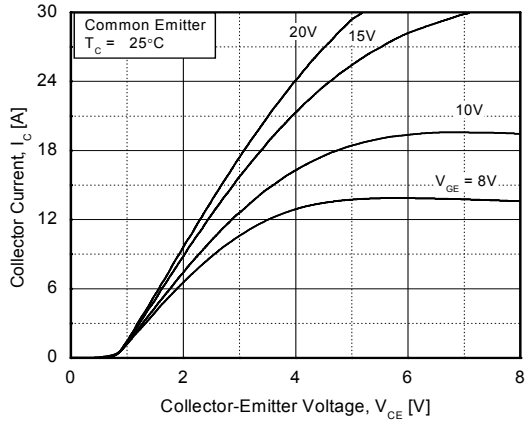

Figure 2. Typical Output Characteristics

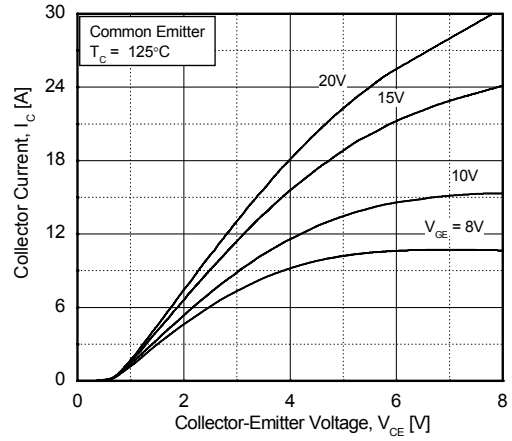

Figure 3. Typical Output Characteristics

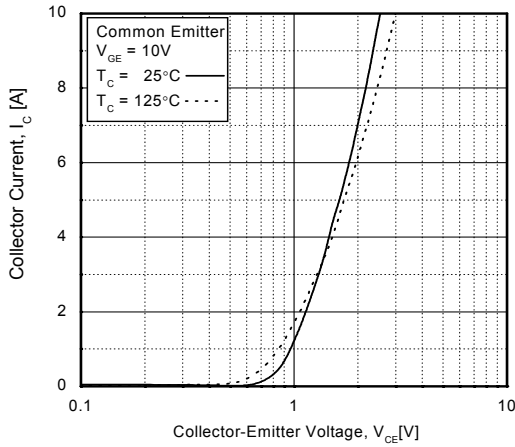

Figure 4. Transfer Characteristics

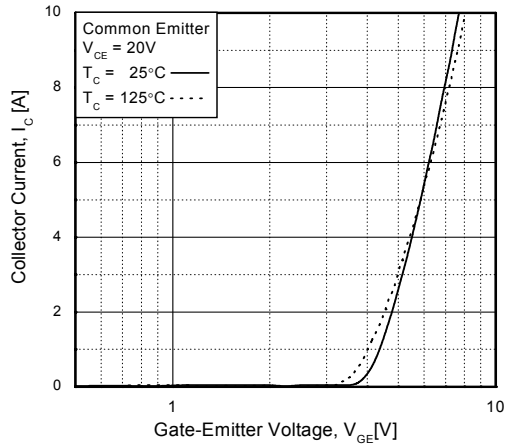

Figure 5. Saturation Voltage vs. Case

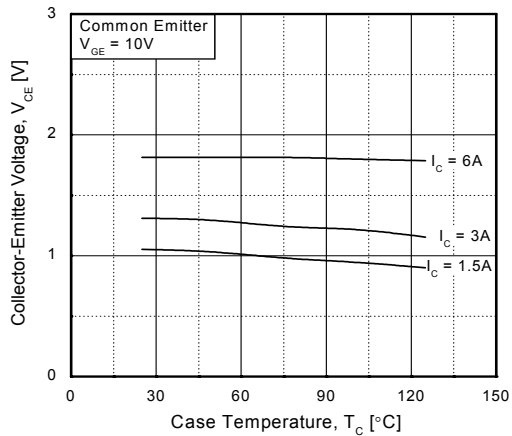
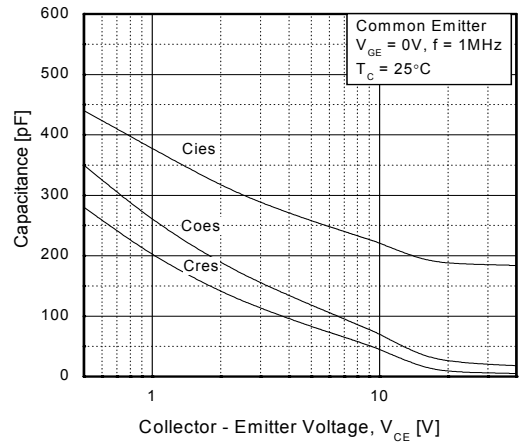

Figure 6. Capacitance Characteristics



Typical Performance Characteristics (Continued)

Figure 7. Gate Charge

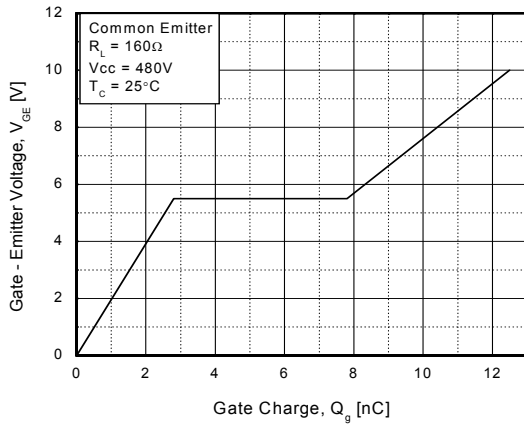

Figure 8. Turn-On Characteristics vs. Gate Resistance

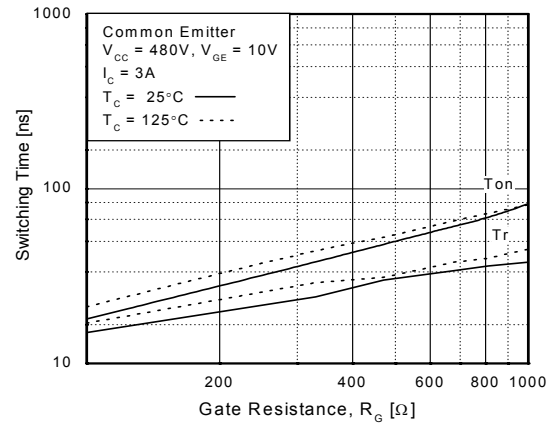

Figure 9. Turn-Off Characteristics vs. Gate Resistance

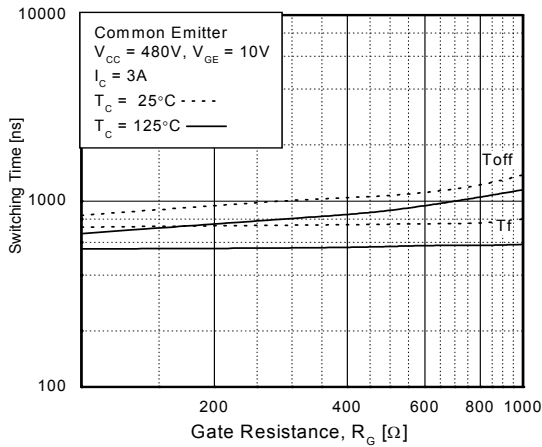

Figure 10. Switching Loss vs. Gate Resistance

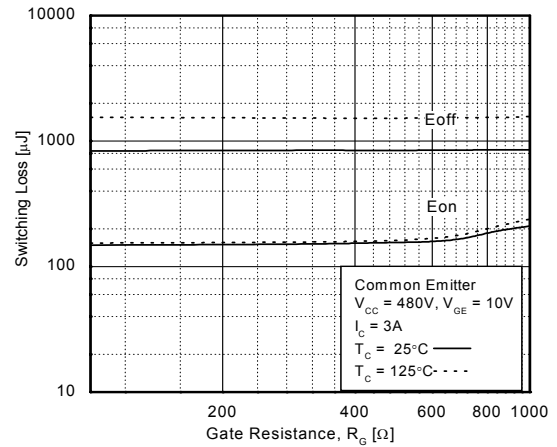

Figure 11. Turn-On Characteristics vs. Collector Current

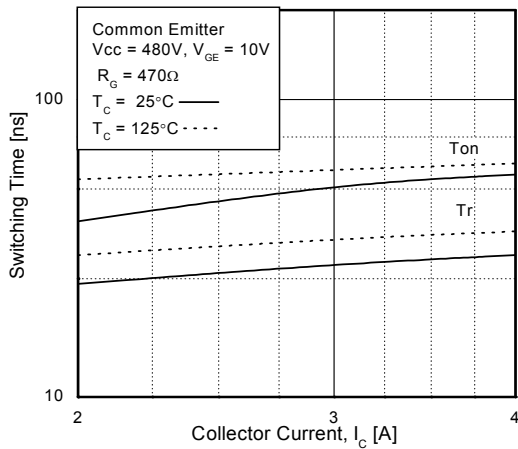
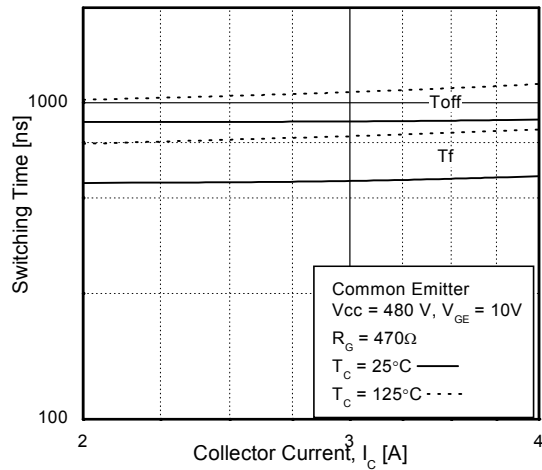

Figure 12. Turn-Off Characteristics vs. Collector Current



Typical Performance Characteristics (Continued)

Figure 13. Switching Loss vs. Collector Current

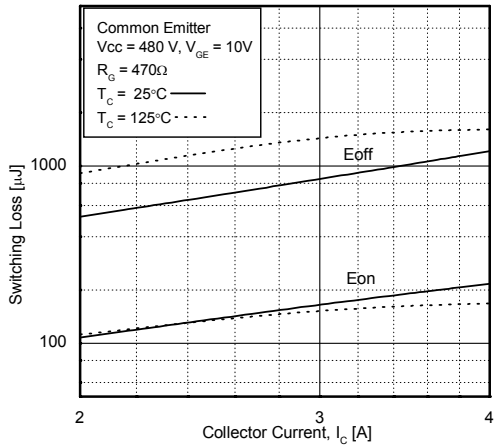

Figure 14. Forward Characteristics

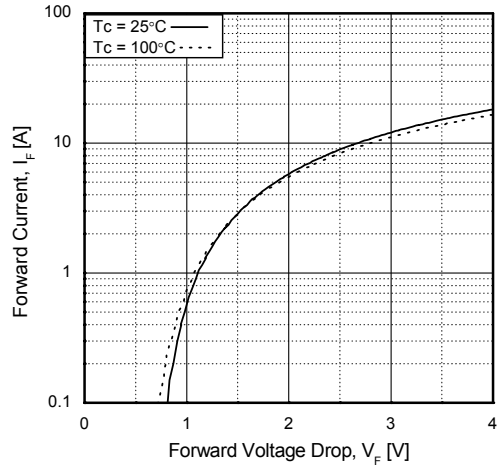

Figure 15. Forward Voltage Drop Vs Tj

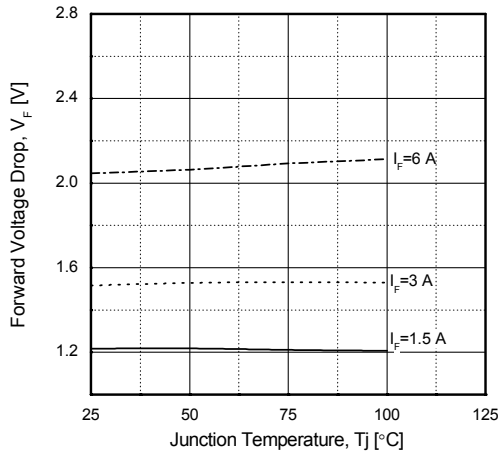

Figure 16. SOA Characteristics

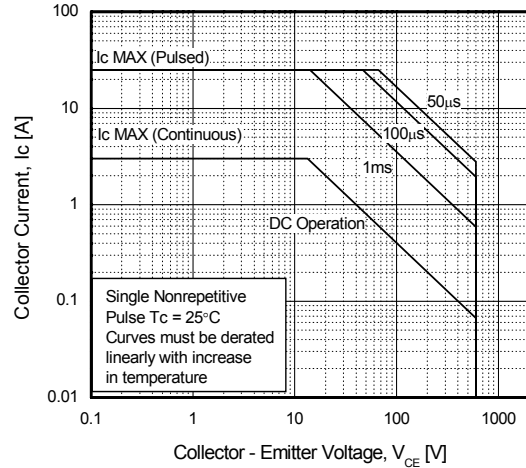
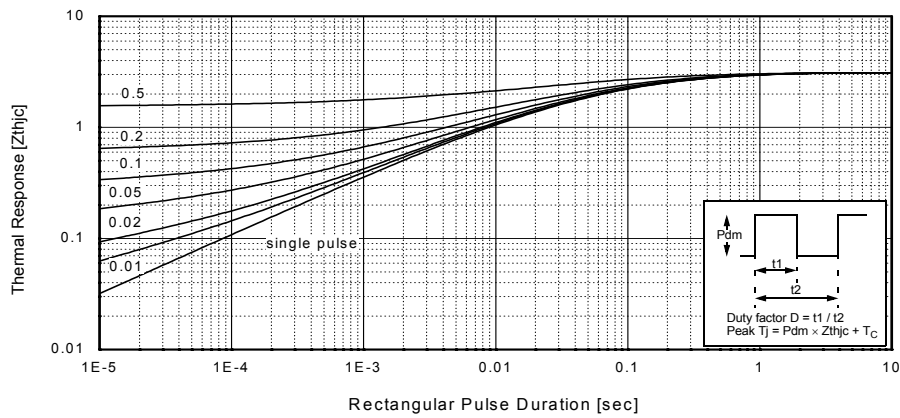
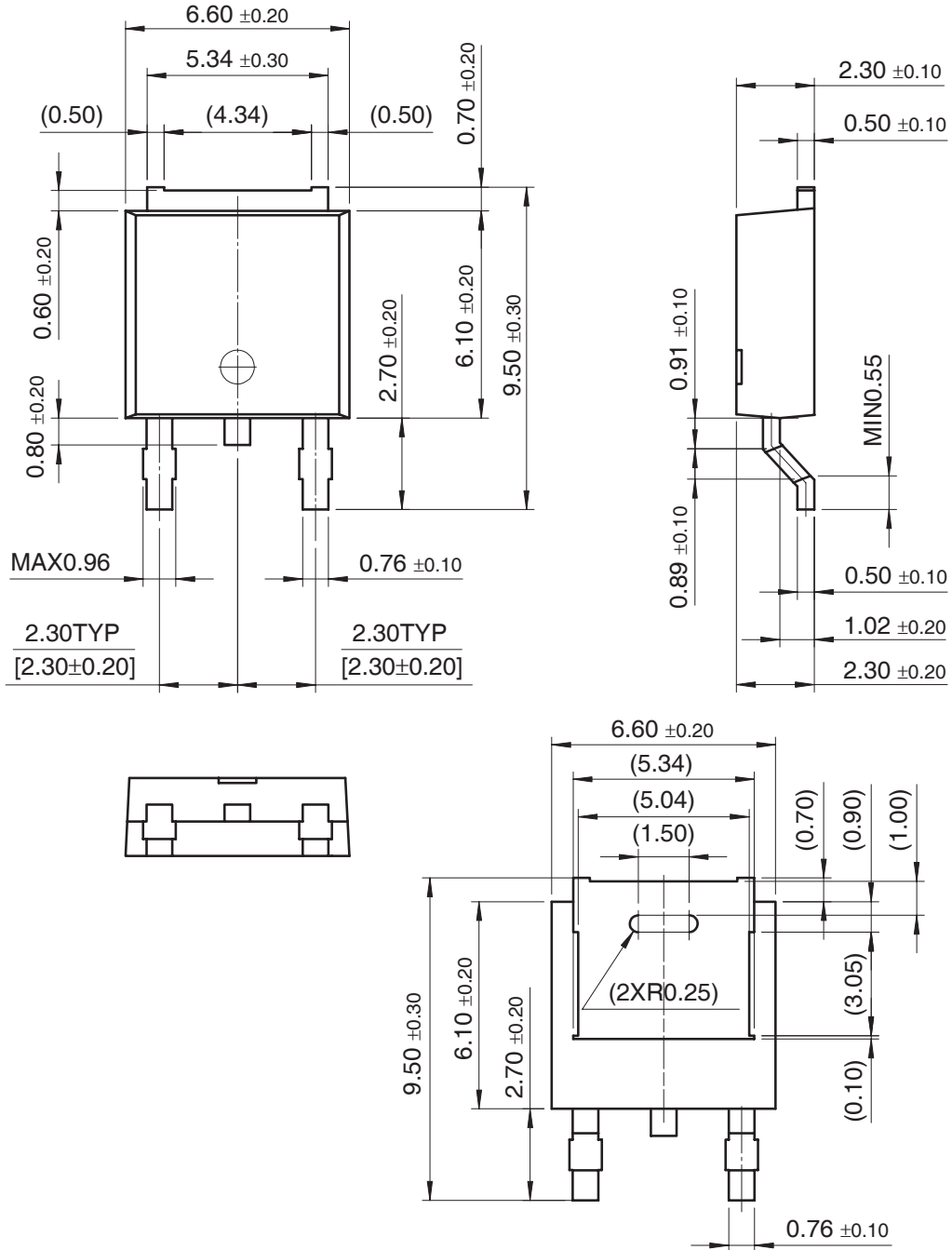

Figure 17. Transient Thermal Impedance of IGBT



Mechanical Dimensions

D-PAK



Dimensions in Millimeters

TRADEMARKS

The following are registered and unregistered trademarks Fairchild Semiconductor owns or is authorized to use and is not intended to be an exhaustive list of all such trademarks.

ACEx™	FACT Quiet Series™	OCX™	SILENT SWITCHER®	UniFET™
ActiveArray™	GlobalOptoisolator™	OCXPro™	SMART START™	UltraFET®
Bottomless™	GTO™	OPTOLOGIC®	SPM™	VCX™
Build it Now™	HiSeC™	OPTOPLANAR™	Stealth™	Wire™
CoolFET™	I ² C™	PACMAN™	SuperFET™	
CROSSVOLT™	i-Lo™	POP™	SuperSOT™-3	
DOME™	ImpliedDisconnect™	Power247™	SuperSOT™-6	
EcoSPARK™	IntelliMAX™	PowerEdge™	SuperSOT™-8	
E ² CMOS™	ISOPLANAR™	PowerSaver™	SyncFET™	
EnSigna™	LittleFET™	PowerTrench®	TCM™	
FACT™	MICROCOUPLER™	QFET®	TinyBoost™	
FAST®	MicroFET™	QS™	TinyBuck™	
FASTr™	MicroPak™	QT Optoelectronics™	TinyPWM™	
FPS™	MICROWIRE™	Quiet Series™	TinyPower™	
FRFET™	MSX™	RapidConfigure™	TinyLogic®	
	MSXPro™	RapidConnect™	TINYOPTO™	
Across the board. Around the world.™		µSerDes™	TruTranslation™	
The Power Franchise®		ScalarPump™	UHC™	
Programmable Active Droop™				

DISCLAIMER

FAIRCHILD SEMICONDUCTOR RESERVES THE RIGHT TO MAKE CHANGES WITHOUT FURTHER NOTICE TO ANY PRODUCTS HEREIN TO IMPROVE RELIABILITY, FUNCTION OR DESIGN. FAIRCHILD DOES NOT ASSUME ANY LIABILITY ARISING OUT OF THE APPLICATION OR USE OF ANY PRODUCT OR CIRCUIT DESCRIBED HEREIN; NEITHER DOES IT CONVEY ANY LICENSE UNDER ITS PATENT RIGHTS, NOR THE RIGHTS OF OTHERS. THESE SPECIFICATIONS DO NOT EXPAND THE TERMS OF FAIRCHILD'S WORLDWIDE TERMS AND CONDITIONS, SPECIFICALLY THE WARRANTY THEREIN, WHICH COVERS THESE PRODUCTS.

LIFE SUPPORT POLICY

FAIRCHILD'S PRODUCTS ARE NOT AUTHORIZED FOR USE AS CRITICAL COMPONENTS IN LIFE SUPPORT DEVICES OR SYSTEMS WITHOUT THE EXPRESS WRITTEN APPROVAL OF FAIRCHILD SEMICONDUCTOR CORPORATION.

As used herein:

1. Life support devices or systems are devices or systems which, (a) are intended for surgical implant into the body, or (b) support or sustain life, or (c) whose failure to perform when properly used in accordance with instructions for use provided in the labeling, can be reasonably expected to result in significant injury to the user.
2. A critical component is any component of a life support device or system whose failure to perform can be reasonably expected to cause the failure of the life support device or system, or to affect its safety or effectiveness.

PRODUCT STATUS DEFINITIONS

Definition of Terms

Datasheet Identification	Product Status	Definition
Advance Information	Formative or In Design	This datasheet contains the design specifications for product development. Specifications may change in any manner without notice.
Preliminary	First Production	This datasheet contains preliminary data, and supplementary data will be published at a later date. Fairchild Semiconductor reserves the right to make changes at any time without notice in order to improve design.
No Identification Needed	Full Production	This datasheet contains final specifications. Fairchild Semiconductor reserves the right to make changes at any time without notice in order to improve design.
Obsolete	Not In Production	This datasheet contains specifications on a product that has been discontinued by Fairchild semiconductor. The datasheet is printed for reference information only.

Rev. I20