

# IGBT - Field Stop, Trench

## 650 V, 40 A

### FGH40T65SPD-F085

#### Description

Using the novel field stop 3<sup>rd</sup> generation IGBT technology, FGH40T65SPD-F085 offers the optimum performance with both low conduction loss and switching loss for a high efficiency operation in various applications, which provides 50 V higher blocking voltage and rugged high current switching reliability.

Meanwhile, this part also offers an advantage of outstanding performance in parallel operation.

#### Features

- Low Saturation Voltage:  $V_{CE(Sat)} = 1.85 \text{ V (Typ.) @ } I_C = 40 \text{ A}$
- 100% Of The Part Are Dynamically Tested (Note 1)
- Short Circuit Ruggedness  $> 5 \mu\text{S @ } 25^\circ\text{C}$
- Maximum Junction Temperature:  $T_J = 175^\circ\text{C}$
- Fast Switching
- Tight Parameter Distribution
- Positive Temperature Co-efficient for Easy Parallel Operating
- Co-Packed With Soft And Fast Recovery Diode
- AEC-Q101 Qualified and PPAP Capable
- This Device is Pb-Free and is RoHS Compliant

#### Applications

- On-board Charger
- Air Conditioner Compressor
- PTC Heater
- Motor Drivers
- Other Automotive Power-Train Applications



**ON Semiconductor®**

[www.onsemi.com](http://www.onsemi.com)

$V_{CES}$	$E_{on}$	$V_{CE(Sat)}$
650 V	1.16 mJ	1.85 V

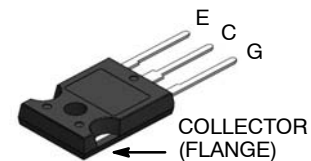
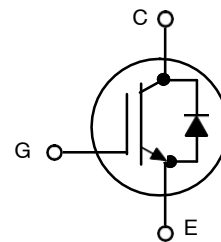

TO-247-3LD  
CASE 340CK

#### MARKING DIAGRAM

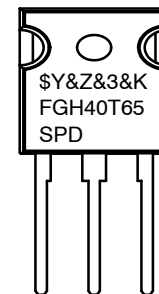

\$Y = ON Semiconductor Logo  
 &Z = Assembly Plant Code  
 &3 = 3-Digit Data code  
 &K = 2-Digit Lot Traceability code  
 FGH40T65SPD = Specific Device Code

#### ORDERING INFORMATION

See detailed ordering and shipping information on page 2 of this data sheet.

# FGH40T65SPD-F085

## ABSOLUTE MAXIMUM RATINGS

Symbol	Description	Ratings	Units
$V_{CES}$	Collector to Emitter Voltage	650	V
$V_{GES}$	Gate to Emitter Voltage	$\pm 20$	V
	Transient Gate to Emitter Voltage	$\pm 30$	V
$I_C$	Collector Current @ $T_C = 25^\circ\text{C}$	80	A
	Collector Current @ $T_C = 100^\circ\text{C}$	40	
$I_{CM}$	Pulsed Collector Current (Note 2)	120	A
$I_F$	Diode Forward Current @ $T_C = 25^\circ\text{C}$	40	A
	Diode Forward Current @ $T_C = 100^\circ\text{C}$	20	
$I_{FM}$	Pulsed Diode Maximum Forward Current (Note 2)	120	A
$P_D$	Maximum Power Dissipation @ $T_C = 25^\circ\text{C}$	267	W
	Maximum Power Dissipation @ $T_C = 100^\circ\text{C}$	134	
SCWT	Short Circuit Withstand Time @ $T_C = 25^\circ\text{C}$	5	$\mu\text{s}$
$T_J$	Operating Junction Temperature	-55 to +175	$^\circ\text{C}$
$T_{stg}$	Storage Temperature Range	-55 to +175	$^\circ\text{C}$
$T_L$	Maximum Lead Temp. For soldering Purposes, $\frac{1}{8}$ " from case for 5 seconds	300	$^\circ\text{C}$

Stresses exceeding those listed in the Maximum Ratings table may damage the device. If any of these limits are exceeded, device functionality should not be assumed, damage may occur and reliability may be affected.

- $V_{CC} = 400\text{ V}$ ,  $V_{GE} = 15\text{ V}$ ,  $I_C = 120\text{ A}$ ,  $R_G = 20\ \Omega$ , Inductive Load.
- Repetitive rating: pulse width limited by max. Junction temperature.

## THERMAL CHARACTERISTICS

Symbol	Rating	Max.	Units
$R_{\theta JC}$	Thermal Resistance Junction to Case, for IGBT	0.56	$^\circ\text{C}/\text{W}$
$R_{\theta JC}$	Thermal Resistance Junction to Case, for Diode	1.71	$^\circ\text{C}/\text{W}$
$R_{\theta JA}$	Thermal Resistance Junction to Ambient	40	$^\circ\text{C}/\text{W}$

## PACKING MARKING AND ORDERING INFORMATION

Device Marking	Device	Package	Pacing Type	Quantity
FGH40T65SPD	FGH40T65SPD-F085	TO-247-3LD	Tube	30

## ELECTRICAL CHARACTERISTICS OF THE IGBT ( $T_C = 25^\circ\text{C}$ unless otherwise noted)

Parameter	Test Conditions	Symbol	Min.	Typ.	Max.	Unit
-----------	-----------------	--------	------	------	------	------

### OFF CHARACTERISTICS

Collector to Emitter Breakdown Voltage	$V_{GE} = 0\text{ V}$ , $I_C = 1\text{ mA}$	$BV_{CES}$	650	-	-	V
Temperature Coefficient of Breakdown Voltage	$V_{GE} = 0\text{ V}$ , $I_C = 1\text{ mA}$	$\frac{\Delta BV_{CES}}{\Delta T_J}$	-	0.6	-	$\text{V}/^\circ\text{C}$
Collector Cut-off Current	$V_{GE} = 0\text{ V}$ , $V_{CE} = V_{CES}$	$I_{CES}$	-	-	250	$\mu\text{A}$
G-E Leakage Current	$V_{GE} = V_{GES}$ , $V_{CE} = 0\text{ V}$	$I_{GES}$	-	-	$\pm 400$	nA

### ON CHARACTERISTICS

G-E Threshold Voltage	$V_{GE} = V_{CE}$ , $I_C = 40\text{ mA}$	$V_{GE(th)}$	4.0	5.5	7.5	V
Collector to Emitter Saturation Voltage	$V_{GE} = 15\text{ V}$ , $I_C = 40\text{ A}$ $V_{GE} = 15\text{ V}$ , $I_C = 40\text{ A}$ , $T_J = 175^\circ\text{C}$	$V_{CE(sat)}$	-	1.85 2.51	2.4 -	V

### DYNAMIC CHARACTERISTICS

# FGH40T65SPD-F085

## ELECTRICAL CHARACTERISTICS OF THE IGBT ( $T_C = 25^\circ\text{C}$ unless otherwise noted) (continued)(continued)

Parameter	Test Conditions	Symbol	Min.	Typ.	Max.	Unit
-----------	-----------------	--------	------	------	------	------

### DYNAMIC CHARACTERISTICS

Input Capacitance	$V_{CE} = 30\text{ V}$ , $V_{GE} = 0\text{ V}$ , $f = 1\text{ MHz}$	$C_{ies}$	-	1518	-	pF
Output Capacitance		$C_{oes}$	-	91	-	
Reverse Transfer Capacitance		$C_{res}$	-	15	-	

### SWITCHING CHARACTERISTICS

Turn-on Delay Time	$T_C = 25^\circ\text{C}$ $V_{CC} = 400\text{ V}$ , $I_C = 40\text{ A}$ $R_g = 6\ \Omega$ $V_{GE} = 15\text{ V}$ Inductive Load	$T_{d(on)}$	-	18	-	ns	
Rise Time		$T_r$	-	42	-		
Turn-off Delay Time		$T_{d(off)}$	-	35	-		
Fall Time			$T_f$	-	10	-	
Turn-on Switching Loss			$E_{on}$	-	1.16	-	mJ
Turn-off Switching Loss			$E_{off}$	-	0.27	-	
Total Switching Loss			$E_{ts}$	-	1.43	-	
Turn-on Delay Time		$T_C = 175^\circ\text{C}$ $V_{CC} = 400\text{ V}$ , $I_C = 40\text{ A}$ $R_g = 6\ \Omega$ $V_{GE} = 15\text{ V}$ Inductive Load	$T_{d(on)}$	-	16	-	ns
Rise Time			$T_r$	-	40	-	
Turn-off Delay Time	$T_{d(off)}$		-	37	-		
Fall Time			$T_f$	-	11	-	
Turn-on Switching Loss			$E_{on}$	-	1.59	-	mJ
Turn-off Switching Loss			$E_{off}$	-	0.42	-	
Total Switching Loss			$E_{ts}$	-	2.01	-	
Gate Charge Total	$V_{CE} = 400\text{ V}$ , $I_C = 40\text{ V}$ , $V_{GE} = 15\text{ V}$		$Q_g$	-	36	-	nC
Gate to Emitter Charge			$Q_{ge}$	-	11	-	
Gate to Collector Charge		$Q_{gc}$	-	12	-		

## ELECTRICAL CHARACTERISTICS OF THE DIODE ( $T_C = 25^\circ\text{C}$ unless otherwise noted)

Parameter	Test Conditions	Symbol	Min.	Typ.	Max.	Unit
Diode Forward Voltage	$I_F = 20\text{ A}$	$T_C = 25^\circ\text{C}$	-	2.2	2.7	V
		$T_C = 175^\circ\text{C}$	-	1.9	-	
Reverse Recovery Energy	$I_F = 20\text{ A}$ , $di_F/dt = 200\text{ A}/\mu\text{s}$	$T_C = 175^\circ\text{C}$	-	51	-	$\mu\text{J}$
Diode Reverse Recovery Time		$T_C = 25^\circ\text{C}$	-	35	-	ns
		$T_C = 175^\circ\text{C}$	-	214	-	
Diode Reverse Recovery Charge		$T_C = 25^\circ\text{C}$	-	58	-	$\mu\text{C}$
	$T_C = 175^\circ\text{C}$	-	776	-		

Product parametric performance is indicated in the Electrical Characteristics for the listed test conditions, unless otherwise noted. Product performance may not be indicated by the Electrical Characteristics if operated under different conditions.

TYPICAL PERFORMANCE CHARACTERISTICS

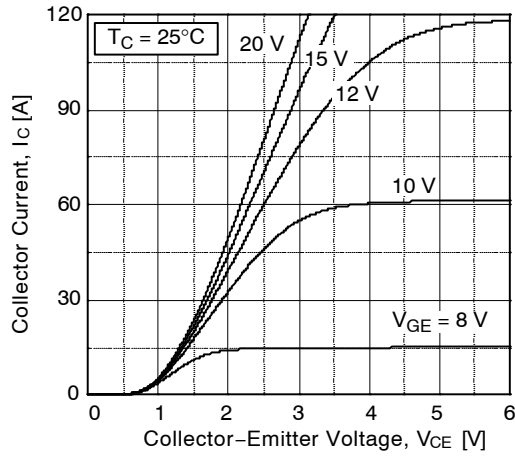

Figure 1. Typical Output Characteristics

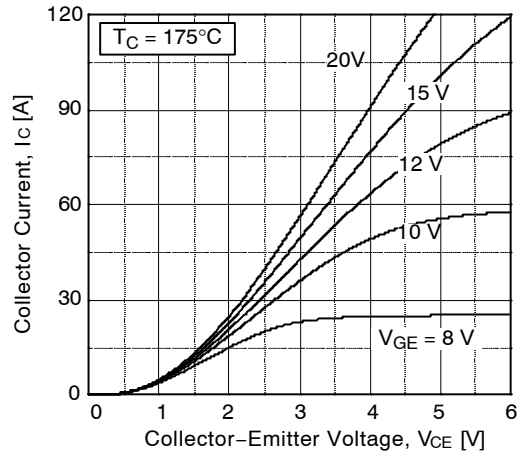

Figure 2. Typical Output Characteristics

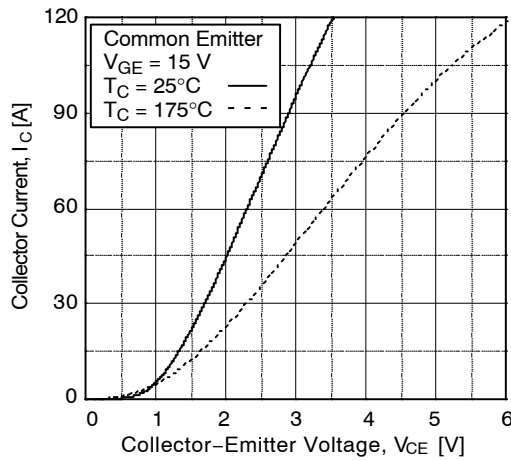

Figure 3. Typical Saturation Voltage Characteristics

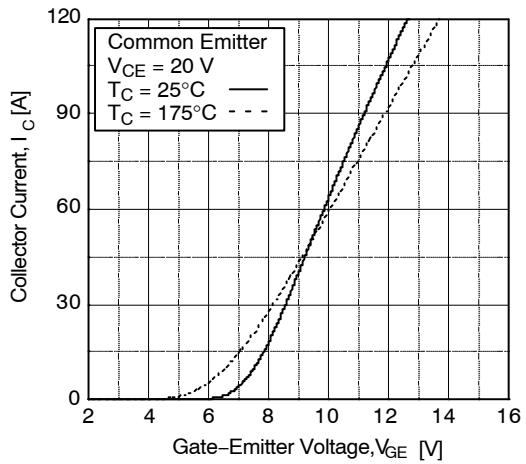

Figure 4. Transfer Characteristics

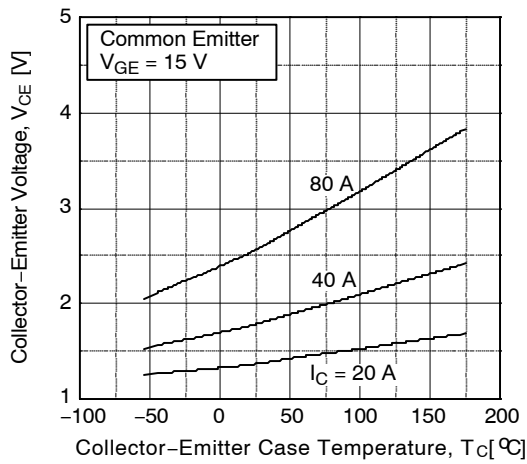

Figure 5. Saturation Voltage vs. Case Temperature at Variant Current Level

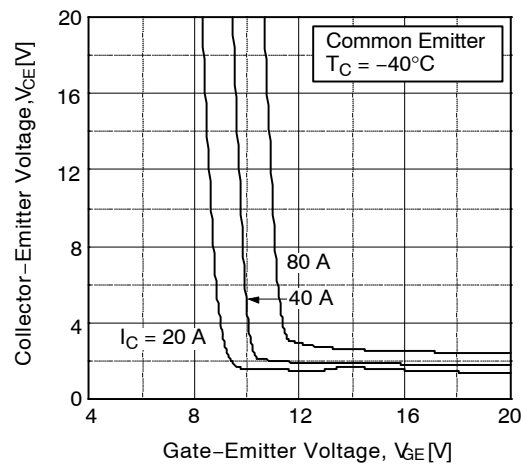

Figure 6. Saturation Voltage vs.  $V_{GE}$

TYPICAL PERFORMANCE CHARACTERISTICS (continued)

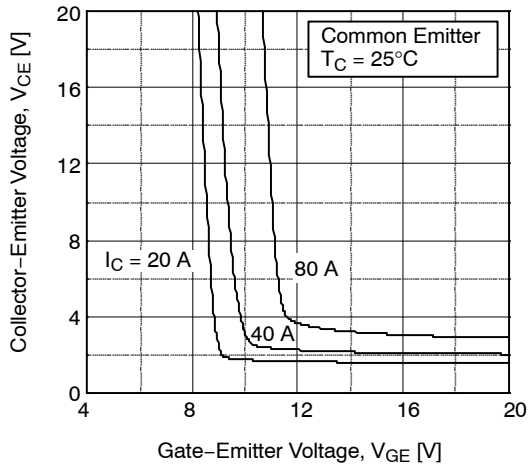

Figure 7. Saturation Voltage vs.  $V_{GE}$

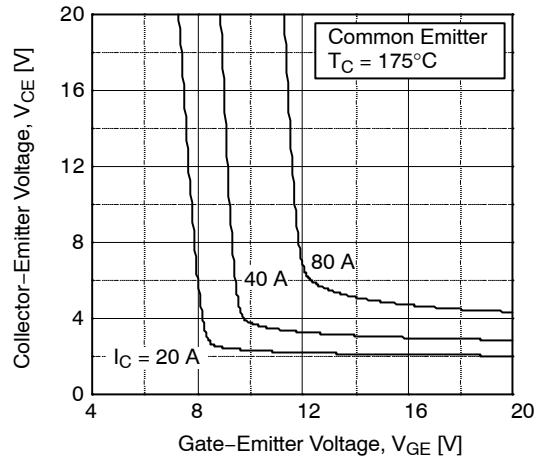

Figure 8. Saturation Voltage vs.  $V_{GE}$

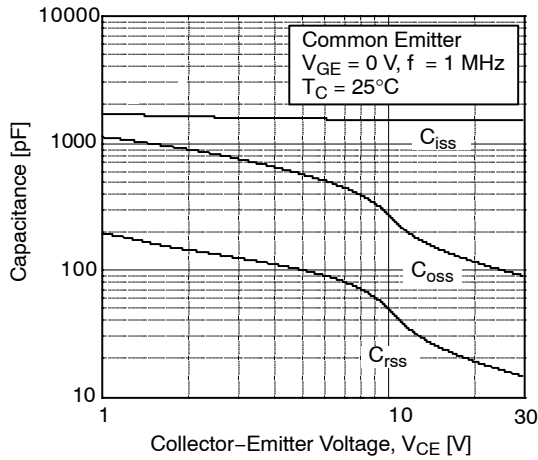

Figure 9. Capacitance Characteristics

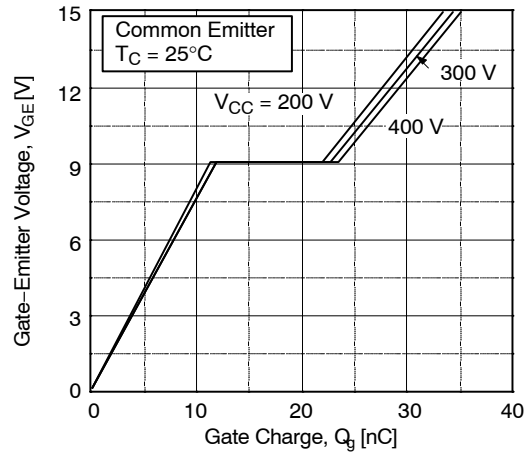

Figure 10. Gate Charge Characteristics

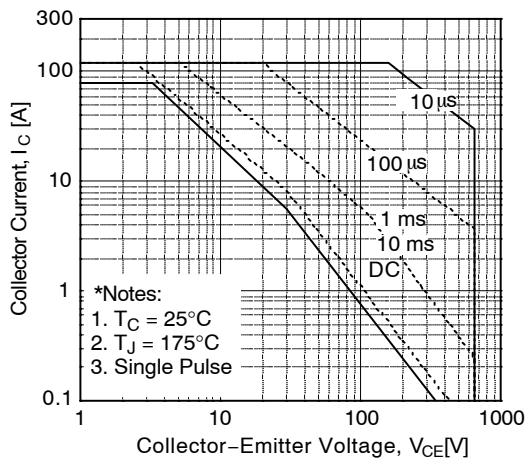

Figure 11. SOA Characteristics

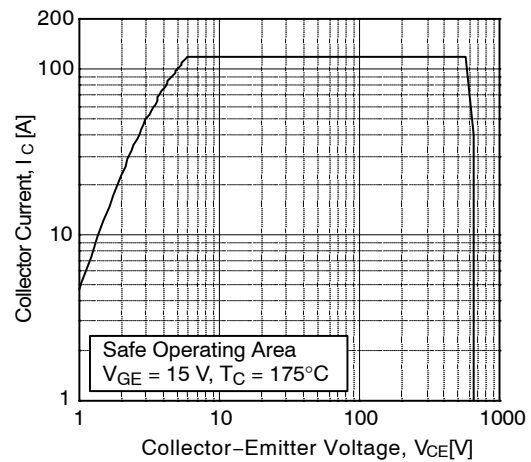

Figure 12. Turn off Switching SOA Characteristics

TYPICAL PERFORMANCE CHARACTERISTICS (continued)

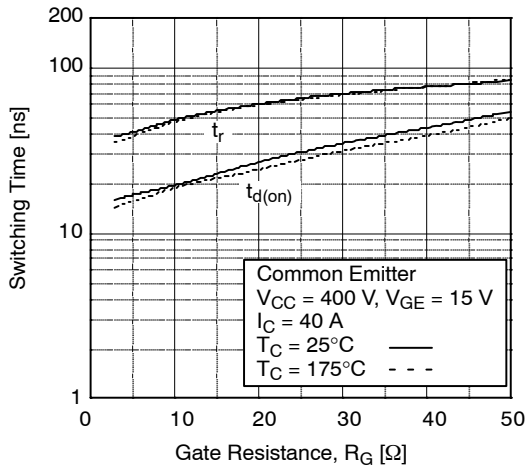

Figure 13. Turn-on Characteristics vs. Gate Resistance

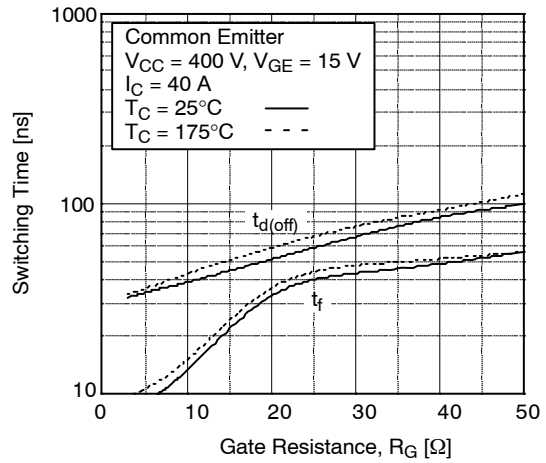

Figure 14. Turn-off Characteristics vs. Gate Resistance

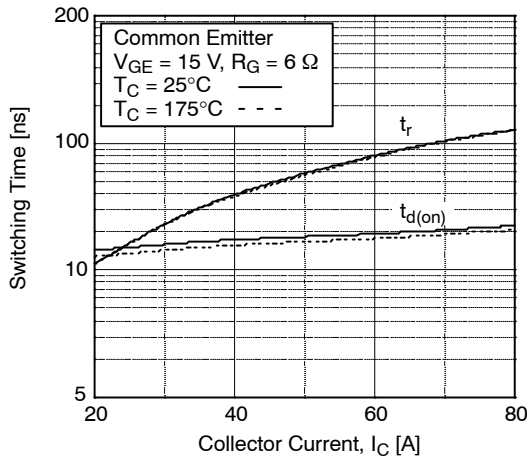

Figure 15. Turn-on Characteristics vs. Collector Current

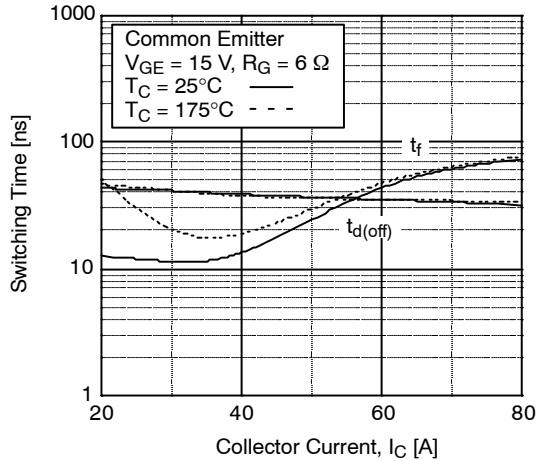

Figure 16. Turn-off Characteristics vs. Collector Current

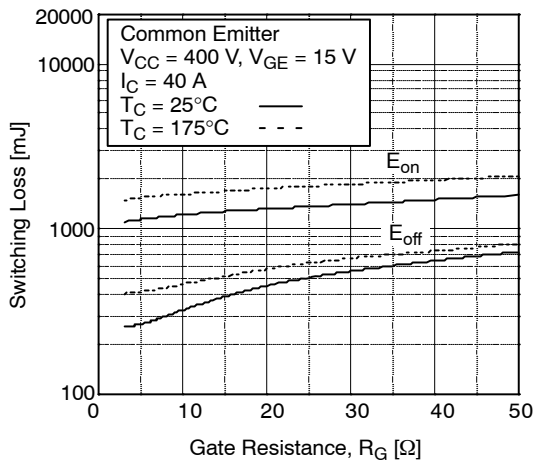

Figure 17. Switching Loss vs Gate Resistance

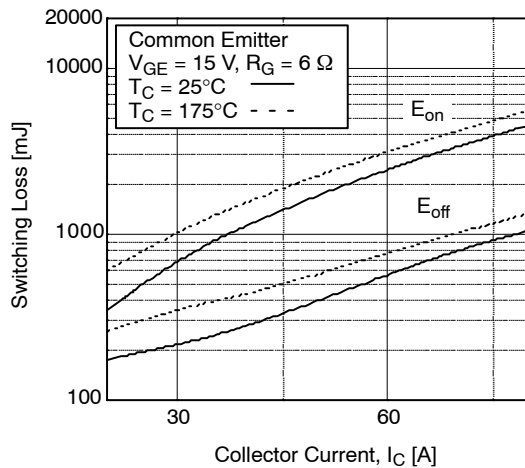

Figure 18. Switching Loss vs Collector Current

TYPICAL PERFORMANCE CHARACTERISTICS (continued)

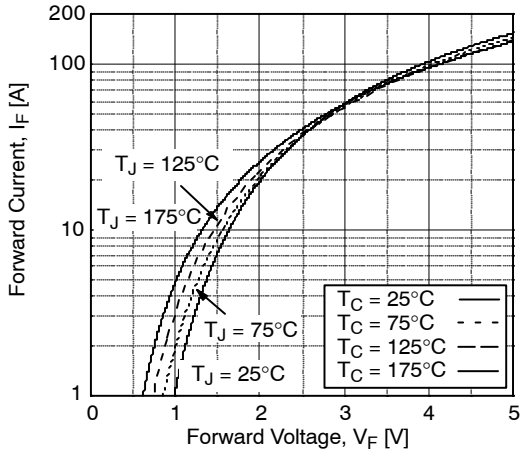

Figure 19. Forward Characteristics

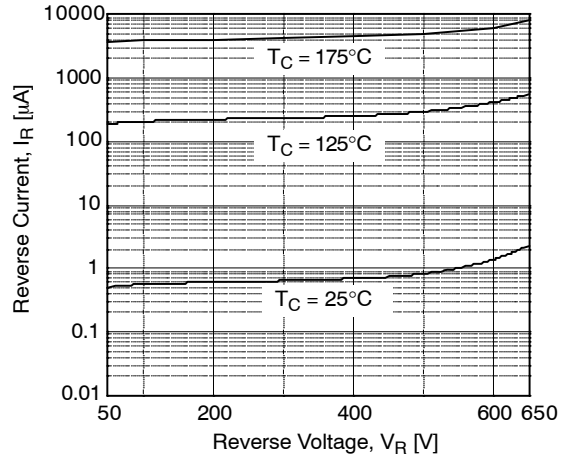

Figure 20. Reverse Current

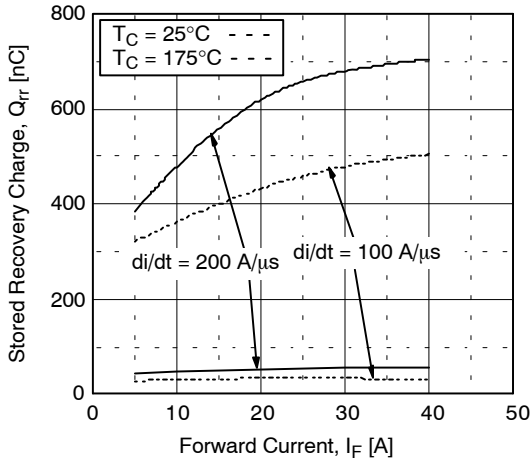

Figure 21. Stored Charge

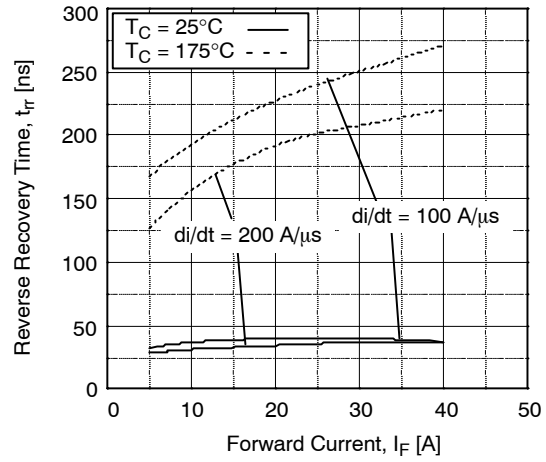

Figure 22. Reverse Recovery Time

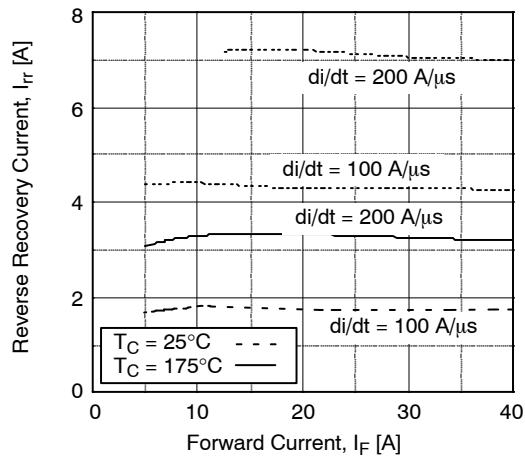

Figure 23. Reverse Recovery Current

TYPICAL PERFORMANCE CHARACTERISTICS (continued)

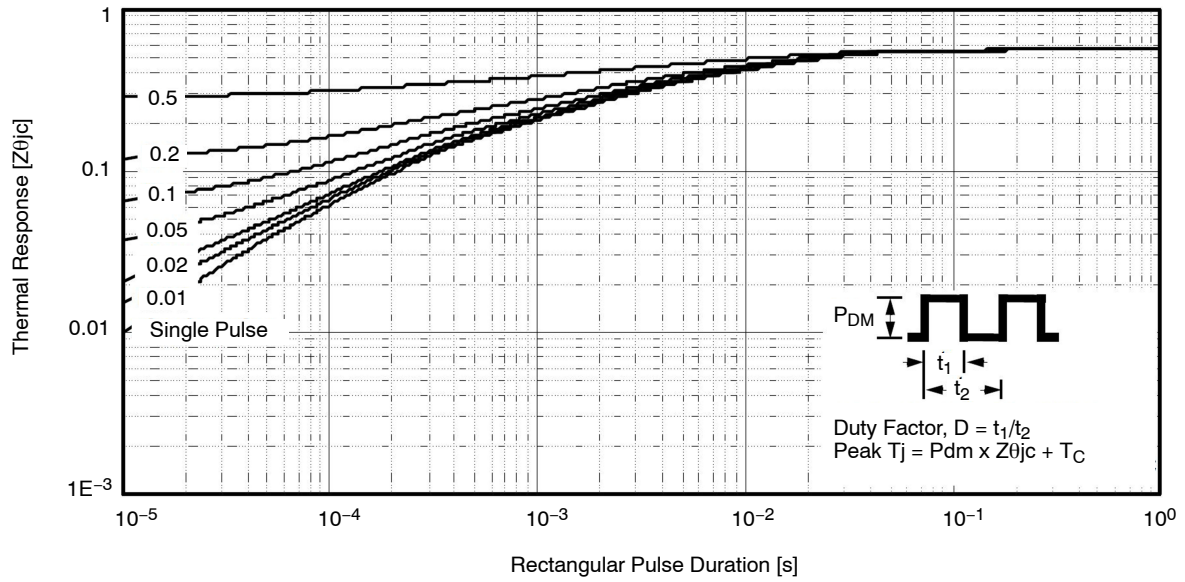

Figure 24. Transient Thermal Impedance of IGBT

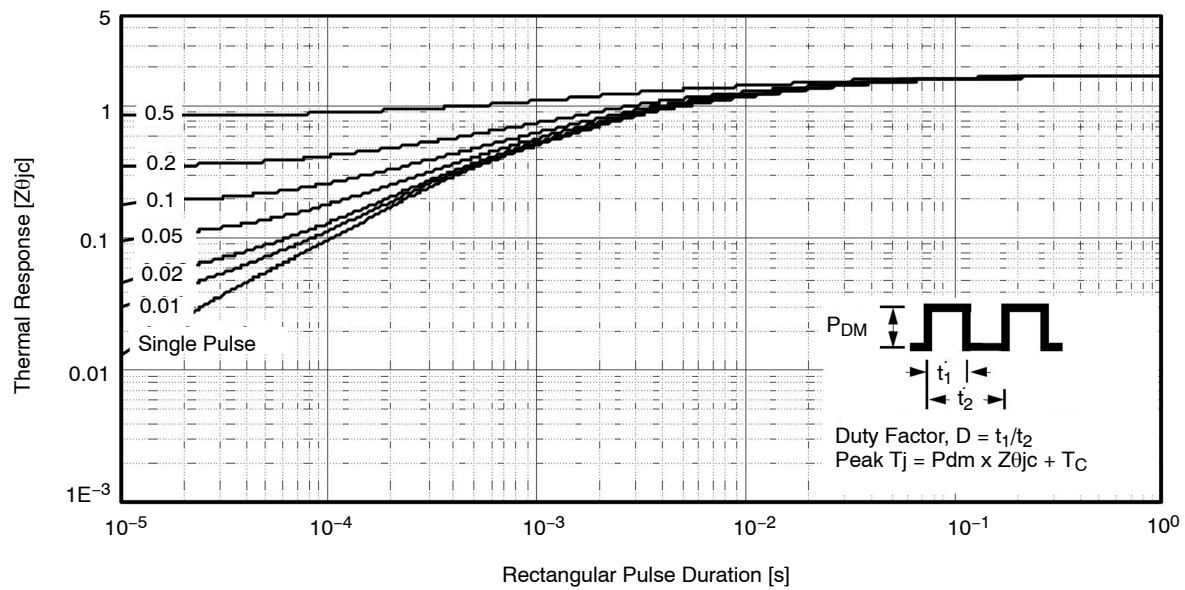

Figure 25. Transient Thermal Impedance of Diode



**TO-247-3LD SHORT LEAD**  
**CASE 340CK**  
**ISSUE A**

DATE 31 JAN 2019



NOTES: UNLESS OTHERWISE SPECIFIED.

- A. DIMENSIONS ARE EXCLUSIVE OF BURRS, MOLD FLASH, AND TIE BAR EXTRUSIONS.
- B. ALL DIMENSIONS ARE IN MILLIMETERS.
- C. DRAWING CONFORMS TO ASME Y14.5 - 2009.
- D. DIMENSION A1 TO BE MEASURED IN THE REGION DEFINED BY L1.
- E. LEAD FINISH IS UNCONTROLLED IN THE REGION DEFINED BY L1.

**GENERIC MARKING DIAGRAM\***



XXXX = Specific Device Code  
 A = Assembly Location  
 Y = Year  
 WW = Work Week  
 ZZ = Assembly Lot Code

\*This information is generic. Please refer to device data sheet for actual part marking. Pb-Free indicator, "G" or microdot "•", may or may not be present. Some products may not follow the Generic Marking.

DIM	MILLIMETERS		
	MIN	NOM	MAX
A	4.58	4.70	4.82
A1	2.20	2.40	2.60
A2	1.40	1.50	1.60
b	1.17	1.26	1.35
b2	1.53	1.65	1.77
b4	2.42	2.54	2.66
c	0.51	0.61	0.71
D	20.32	20.57	20.82
D1	13.08	~	~
D2	0.51	0.93	1.35
E	15.37	15.62	15.87
E1	12.81	~	~
E2	4.96	5.08	5.20
e	~	5.56	~
L	15.75	16.00	16.25
L1	3.69	3.81	3.93
ØP	3.51	3.58	3.65
ØP1	6.60	6.80	7.00
Q	5.34	5.46	5.58
S	5.34	5.46	5.58

<b>DOCUMENT NUMBER:</b>	<b>98AON13851G</b>	Electronic versions are uncontrolled except when accessed directly from the Document Repository. Printed versions are uncontrolled except when stamped "CONTROLLED COPY" in red.
<b>DESCRIPTION:</b>	<b>TO-247-3LD SHORT LEAD</b>	<b>PAGE 1 OF 1</b>

ON Semiconductor and are trademarks of Semiconductor Components Industries, LLC dba ON Semiconductor or its subsidiaries in the United States and/or other countries. ON Semiconductor reserves the right to make changes without further notice to any products herein. ON Semiconductor makes no warranty, representation or guarantee regarding the suitability of its products for any particular purpose, nor does ON Semiconductor assume any liability arising out of the application or use of any product or circuit, and specifically disclaims any and all liability, including without limitation special, consequential or incidental damages. ON Semiconductor does not convey any license under its patent rights nor the rights of others.

**onsemi**, **Onsemi**, and other names, marks, and brands are registered and/or common law trademarks of Semiconductor Components Industries, LLC dba "**onsemi**" or its affiliates and/or subsidiaries in the United States and/or other countries. **onsemi** owns the rights to a number of patents, trademarks, copyrights, trade secrets, and other intellectual property. A listing of **onsemi**'s product/patent coverage may be accessed at [www.onsemi.com/site/pdf/Patent-Marking.pdf](http://www.onsemi.com/site/pdf/Patent-Marking.pdf). **onsemi** reserves the right to make changes at any time to any products or information herein, without notice. The information herein is provided "as-is" and **onsemi** makes no warranty, representation or guarantee regarding the accuracy of the information, product features, availability, functionality, or suitability of its products for any particular purpose, nor does **onsemi** assume any liability arising out of the application or use of any product or circuit, and specifically disclaims any and all liability, including without limitation special, consequential or incidental damages. Buyer is responsible for its products and applications using **onsemi** products, including compliance with all laws, regulations and safety requirements or standards, regardless of any support or applications information provided by **onsemi**. "Typical" parameters which may be provided in **onsemi** data sheets and/or specifications can and do vary in different applications and actual performance may vary over time. All operating parameters, including "Typicals" must be validated for each customer application by customer's technical experts. **onsemi** does not convey any license under any of its intellectual property rights nor the rights of others. **onsemi** products are not designed, intended, or authorized for use as a critical component in life support systems or any FDA Class 3 medical devices or medical devices with a same or similar classification in a foreign jurisdiction or any devices intended for implantation in the human body. Should Buyer purchase or use **onsemi** products for any such unintended or unauthorized application, Buyer shall indemnify and hold **onsemi** and its officers, employees, subsidiaries, affiliates, and distributors harmless against all claims, costs, damages, and expenses, and reasonable attorney fees arising out of, directly or indirectly, any claim of personal injury or death associated with such unintended or unauthorized use, even if such claim alleges that **onsemi** was negligent regarding the design or manufacture of the part. **onsemi** is an Equal Opportunity/Affirmative Action Employer. This literature is subject to all applicable copyright laws and is not for resale in any manner.

## PUBLICATION ORDERING INFORMATION

### LITERATURE FULFILLMENT:

Email Requests to: [orderlit@onsemi.com](mailto:orderlit@onsemi.com)

**onsemi Website:** [www.onsemi.com](http://www.onsemi.com)

### TECHNICAL SUPPORT

**North American Technical Support:**

Voice Mail: 1 800-282-9855 Toll Free USA/Canada

Phone: 011 421 33 790 2910

**Europe, Middle East and Africa Technical Support:**

Phone: 00421 33 790 2910

For additional information, please contact your local Sales Representative