

# Field Stop Trench IGBT

## 650 V, 50 A

### FGHL50T65MQDTL4

Field stop 4<sup>th</sup> generation mid speed IGBT technology copacked with full rated current diode.

#### Features

- Maximum Junction Temperature:  $T_J = 175^\circ\text{C}$
- Positive Temperature Co-efficient for Easy Parallel Operating
- High Current Capability
- Low Saturation Voltage:  $V_{CE(Sat)} = 1.45\text{ V (Typ.) @ } I_C = 50\text{ A}$
- 100% of the Parts are Tested for  $I_{LM}$  (Note 2)
- Smooth and Optimized Switching
- Tight Parameter Distribution
- RoHS Compliant

#### Typical Applications

- Solar Inverter
- UPS, ESS
- PFC, Converters

#### MAXIMUM RATINGS

Parameter	Symbol	Value	Unit
Collector to Emitter Voltage	$V_{CES}$	650	V
Gate to Emitter Voltage Transient Gate to Emitter Voltage	$V_{GES}$	$\pm 20$ $\pm 30$	V
Collector Current (Note 1) @ $T_C = 25^\circ\text{C}$ @ $T_C = 100^\circ\text{C}$	$I_C$	80 50	A
Pulsed Collector Current (Note 2)	$I_{LM}$	200	A
Pulsed Collector Current (Note 3)	$I_{CM}$	200	A
Diode Forward Current (Note 1) @ $T_C = 25^\circ\text{C}$ @ $T_C = 100^\circ\text{C}$	$I_F$	60 50	A
Pulsed Diode Maximum Forward Current	$I_{FM}$	200	A
Maximum Power Dissipation @ $T_C = 25^\circ\text{C}$ @ $T_C = 100^\circ\text{C}$	$P_D$	268 134	W
Operating Junction and Storage Temperature Range	$T_J, T_{STG}$	-55 to +175	$^\circ\text{C}$
Maximum Lead Temp. for Soldering Purposes (1/8" from case for 5 s)	$T_L$	260	$^\circ\text{C}$

Stresses exceeding those listed in the Maximum Ratings table may damage the device. If any of these limits are exceeded, device functionality should not be assumed, damage may occur and reliability may be affected.

1. Value limit by bond wire
2.  $V_{CC} = 400\text{ V}$ ,  $V_{GE} = 15\text{ V}$ ,  $I_C = 200\text{ A}$ , Inductive Load, 100% tested
3. Repetitive rating: pulse width limited by max. junction temperature



ON Semiconductor®

[www.onsemi.com](http://www.onsemi.com)

50 A, 650 V  
 $V_{CESat} = 1.45\text{ V}$

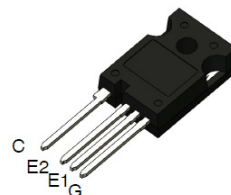
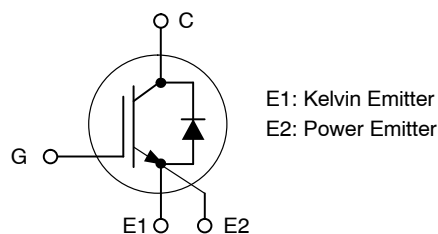

TO-247-4LD  
CASE 340CJ

#### MARKING DIAGRAM

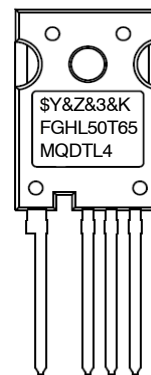

\$Y = ON Semiconductor Logo  
&Z = Assembly Plant Code  
&3 = 3-Digit Date Code  
&K = 2-Digit Lot Traceability Code  
FGHL50T65MQDTL4 = Specific Device Code

#### ORDERING INFORMATION

Device	Package	Shipping
FGHL50T65MQDTL4	TO-247-4LD	30 Units / Tube

# FGHL50T65MQDTL4

## THEMAL CHARACTERISTICS

Rating	Symbol	Value	Unit
Thermal resistance junction-to-case, for IGBT	$R_{\theta JC}$	0.56	$^{\circ}\text{C/W}$
Thermal resistance junction-to-case, for Diode	$R_{\theta JC}$	0.74	$^{\circ}\text{C/W}$
Thermal resistance junction-to-ambient	$R_{\theta JA}$	40	$^{\circ}\text{C/W}$

## ELECTRICAL CHARACTERISTICS ( $T_J = 25^{\circ}\text{C}$ unless otherwise noted)

Parameter	Test Conditions	Symbol	Min	Typ	Max	Unit
-----------	-----------------	--------	-----	-----	-----	------

### OFF CHARACTERISTICS

Collector to Emitter Breakdown Voltage	$V_{GE} = 0\text{ V},$ $I_C = 1\text{ mA}$	$BV_{CES}$	650	-	-	V
Temperature Coefficient of Breakdown Voltage	$V_{GE} = 0\text{ V},$ $I_C = 1\text{ mA}$	$\frac{\Delta BV_{CES}}{\Delta T_J}$	-	0.6	-	$\text{V}/^{\circ}\text{C}$
Collector to Emitter Cut-off Current	$V_{GE} = 0\text{ V},$ $V_{CE} = 650\text{ V}$	$I_{CES}$	-	-	250	$\mu\text{A}$
Gate Leakage Current	$V_{GE} = 20\text{ V},$ $V_{CE} = 0\text{ V}$	$I_{GES}$	-	-	$\pm 400$	nA

### ON CHARACTERISTICS

Gate to Emitter Threshold Voltage	$V_{GE} = V_{CE}, I_C = 50\text{ mA}$	$V_{GE(th)}$	3.0	4.5	6.0	V
Collector to Emitter Saturation Voltage	$V_{GE} = 15\text{ V}, I_C = 50\text{ A}, T_J = 25^{\circ}\text{C}$ $V_{GE} = 15\text{ V}, I_C = 50\text{ A}, T_J = 175^{\circ}\text{C}$	$V_{CE(sat)}$	-	1.45 1.65	1.8 -	V

### DYNAMIC CHARACTERISTICS

Input Capacitance	$V_{CE} = 30\text{ V},$ $V_{GE} = 0\text{ V},$ $f = 1\text{ MHz}$	$C_{ies}$	-	3335	-	pF
Output Capacitance		$C_{oes}$	-	105	-	
Reverse Transfer Capacitance		$C_{res}$	-	11	-	
Gate Charge Total	$V_{CE} = 400\text{ V},$ $I_C = 50\text{ A},$ $V_{GE} = 15\text{ V}$	$Q_g$	-	99	-	nC
Gate to Emitter Charge		$Q_{ge}$	-	17	-	
Gate to Collector Charge		$Q_{gc}$	-	24	-	

### SWITCHING CHARACTERISTICS, INDUCTIVE LOAD

Turn-on Delay Time	$T_J = 25^{\circ}\text{C},$ $V_{CC} = 400\text{ V},$ $I_C = 25\text{ A},$ $R_G = 30\ \Omega,$ $V_{GE} = 15\text{ V}$	$t_{d(on)}$	-	45	-	ns
Rise Time		$t_r$	-	18	-	
Turn-off Delay Time		$t_{d(off)}$	-	360	-	
Fall Time		$t_f$	-	51	-	
Turn-on Switching Loss		$E_{on}$	-	0.44	-	mJ
Turn-off Switching Loss		$E_{off}$	-	0.35	-	
Total Switching Loss		$E_{ts}$	-	0.79	-	
Turn-on Delay Time		$T_J = 25^{\circ}\text{C},$ $V_{CC} = 400\text{ V},$ $I_C = 50\text{ A},$ $R_G = 30\ \Omega,$ $V_{GE} = 15\text{ V}$	$t_{d(on)}$	-	50	
Rise Time	$t_r$		-	27	-	
Turn-off Delay Time	$t_{d(off)}$		-	336	-	
Fall Time	$t_f$		-	37	-	
Turn-on Switching Loss		$E_{on}$	-	1.00	-	mJ
Turn-off Switching Loss		$E_{off}$	-	0.85	-	
Total Switching Loss		$E_{ts}$	-	1.85	-	

# FGHL50T65MQDTL4

## ELECTRICAL CHARACTERISTICS ( $T_J = 25^\circ\text{C}$ unless otherwise noted)

Parameter	Test Conditions	Symbol	Min	Typ	Max	Unit
-----------	-----------------	--------	-----	-----	-----	------

### SWITCHING CHARACTERISTICS, INDUCTIVE LOAD

Turn-on Delay Time	$T_J = 175^\circ\text{C}$ , $V_{CC} = 400\text{ V}$ , $I_C = 25\text{ A}$ , $R_G = 30\ \Omega$ , $V_{GE} = 15\text{ V}$	$t_{d(on)}$	-	40	-	ns
Rise Time		$t_r$	-	22	-	
Turn-off Delay Time		$t_{d(off)}$	-	389	-	
Fall Time		$t_f$	-	85	-	
Turn-on Switching Loss		$E_{on}$	-	0.84	-	mJ
Turn-off Switching Loss		$E_{off}$	-	0.61	-	
Total Switching Loss		$E_{ts}$	-	1.45	-	
Turn-on Delay Time	$T_J = 175^\circ\text{C}$ , $V_{CC} = 400\text{ V}$ , $I_C = 50\text{ A}$ , $R_G = 30\ \Omega$ , $V_{GE} = 15\text{ V}$	$t_{d(on)}$	-	43	-	ns
Rise Time		$t_r$	-	35	-	
Turn-off Delay Time		$t_{d(off)}$	-	365	-	
Fall Time		$t_f$	-	72	-	
Turn-on Switching Loss		$E_{on}$	-	1.60	-	mJ
Turn-off Switching Loss		$E_{off}$	-	1.30	-	
Total Switching Loss		$E_{ts}$	-	2.90	-	

### DIODE CHARACTERISTICS

Diode Forward Voltage	$I_F = 50\text{ A}$ , $T_J = 25^\circ\text{C}$	$V_F$	-	1.65	2.1	V
	$I_F = 50\text{ A}$ , $T_J = 175^\circ\text{C}$		-	1.55	-	

### DIODE SWITCHING CHARACTERISTICS, INDUCTIVE LOAD

Reverse Recovery Energy	$T_J = 25^\circ\text{C}$ , $V_{CE} = 400\text{ V}$ , $I_F = 25\text{ A}$ , $di_F/dt = 1000\text{ A}/\mu\text{s}$	$E_{rec}$	-	65	-	$\mu\text{J}$
Diode Reverse Recovery Time		$T_{rr}$	-	44	-	ns
Diode Reverse Recovery Charge		$Q_{rr}$	-	387	-	nC
Diode Reverse Recovery Current		$I_{rr}$	-	18	-	A
Reverse Recovery Energy	$T_J = 25^\circ\text{C}$ , $V_{CE} = 400\text{ V}$ , $I_F = 50\text{ A}$ , $di_F/dt = 1000\text{ A}/\mu\text{s}$	$E_{rec}$	-	128	-	$\mu\text{J}$
Diode Reverse Recovery Time		$T_{rr}$	-	79	-	ns
Diode Reverse Recovery Charge		$Q_{rr}$	-	681	-	nC
Diode Reverse Recovery Current		$I_{rr}$	-	17	-	A
Reverse Recovery Energy	$T_J = 175^\circ\text{C}$ , $V_{CE} = 400\text{ V}$ , $I_F = 25\text{ A}$ , $di_F/dt = 1000\text{ A}/\mu\text{s}$	$E_{rec}$	-	380	-	$\mu\text{J}$
Diode Reverse Recovery Time		$T_{rr}$	-	102	-	ns
Diode Reverse Recovery Charge		$Q_{rr}$	-	1482	-	nC
Diode Reverse Recovery Current		$I_{rr}$	-	29	-	A
Reverse Recovery Energy	$T_J = 175^\circ\text{C}$ , $V_{CE} = 400\text{ V}$ , $I_F = 50\text{ A}$ , $di_F/dt = 1000\text{ A}/\mu\text{s}$	$E_{rec}$	-	544	-	$\mu\text{J}$
Diode Reverse Recovery Time		$T_{rr}$	-	135	-	ns
Diode Reverse Recovery Charge		$Q_{rr}$	-	2023	-	nC
Diode Reverse Recovery Current		$I_{rr}$	-	30	-	A

Product parametric performance is indicated in the Electrical Characteristics for the listed test conditions, unless otherwise noted. Product performance may not be indicated by the Electrical Characteristics if operated under different conditions.

# FGHL50T65MQDTL4

## TYPICAL CHARACTERISTICS

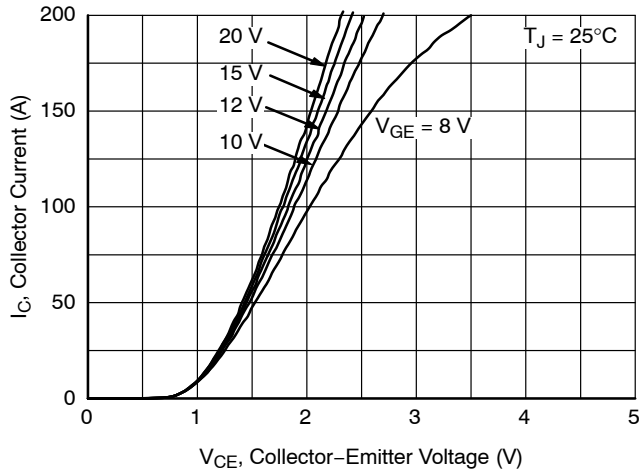

Figure 1. Typical Output Characteristics ( $T_J = 25^\circ\text{C}$ )

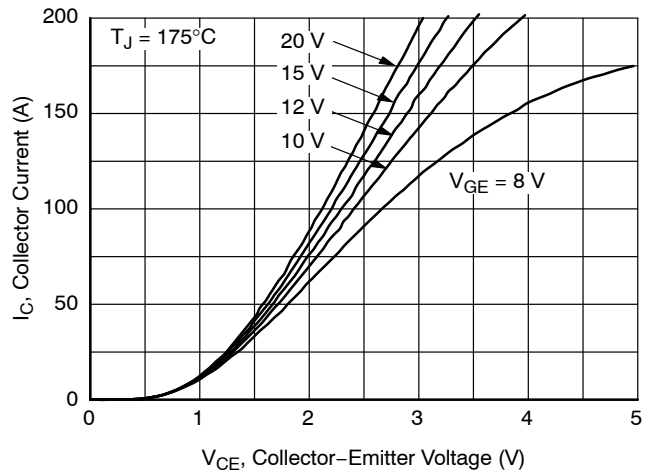

Figure 2. Typical Output Characteristics ( $T_J = 175^\circ\text{C}$ )

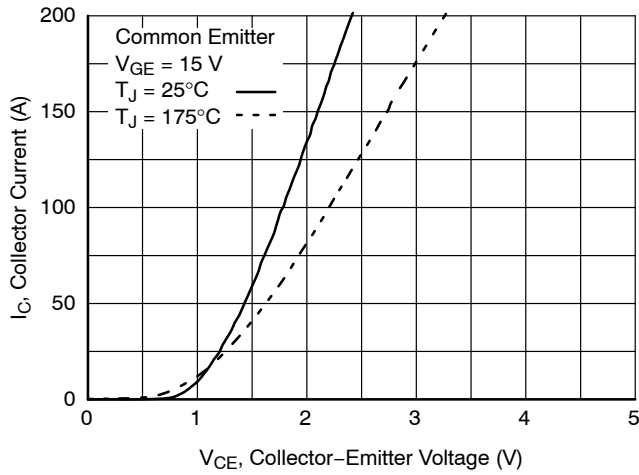

Figure 3. Typical Saturation Voltage Characteristics

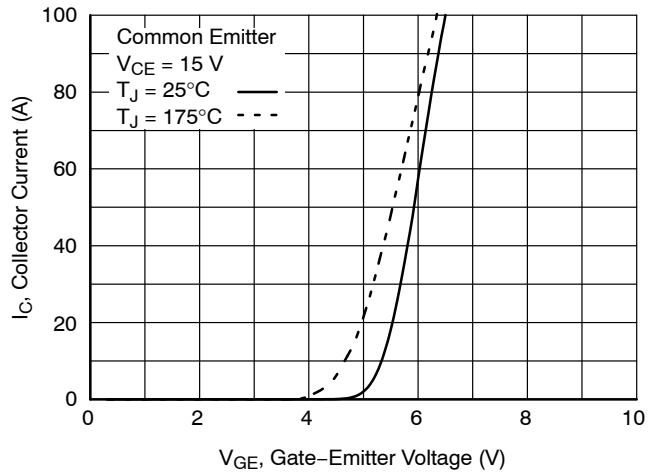

Figure 4. Typical Transfer Characteristics

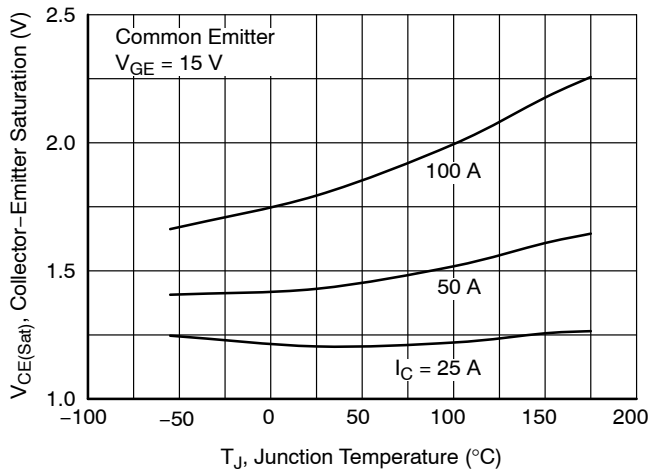

Figure 5. Saturation Voltage vs. Junction Temperature

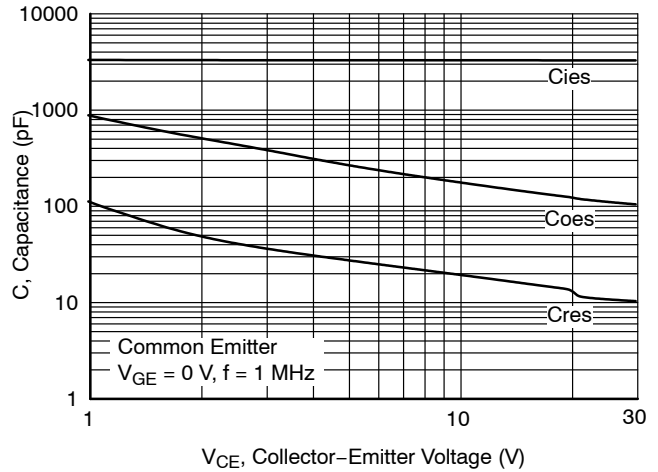
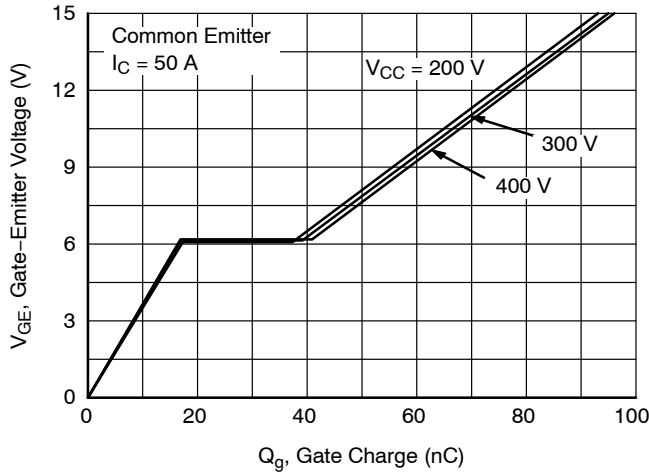

Figure 6. Capacitance Characteristics

# FGHL50T65MQDTL4

## TYPICAL CHARACTERISTICS (continued)



**Figure 7. Gate Charge Characteristics**

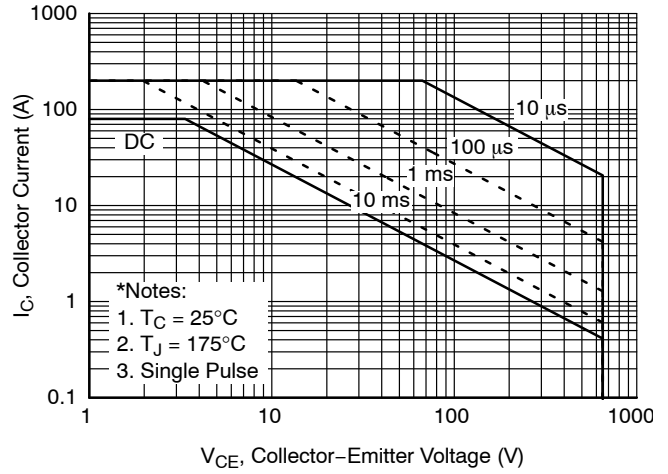

**Figure 8. SOA Characteristics**

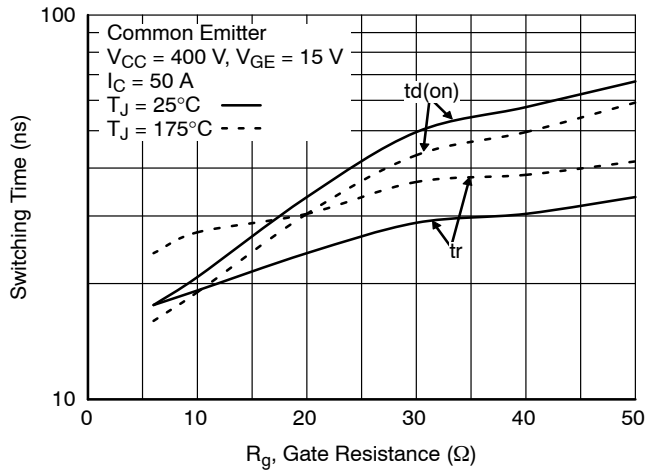

**Figure 9. Turn-on Characteristics vs. Gate Resistance**

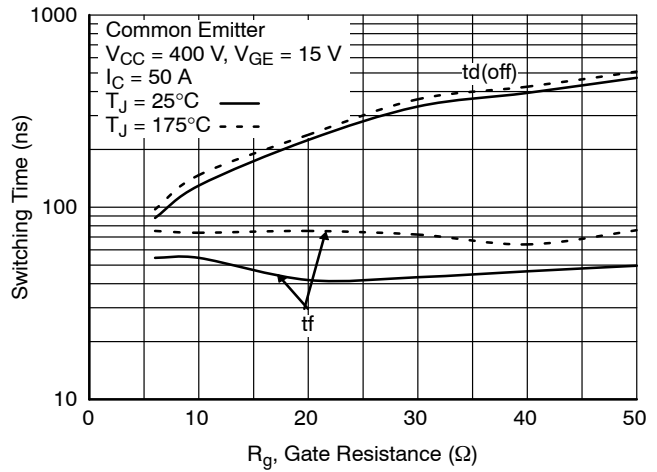

**Figure 10. Turn-off Characteristics vs. Gate Resistance**

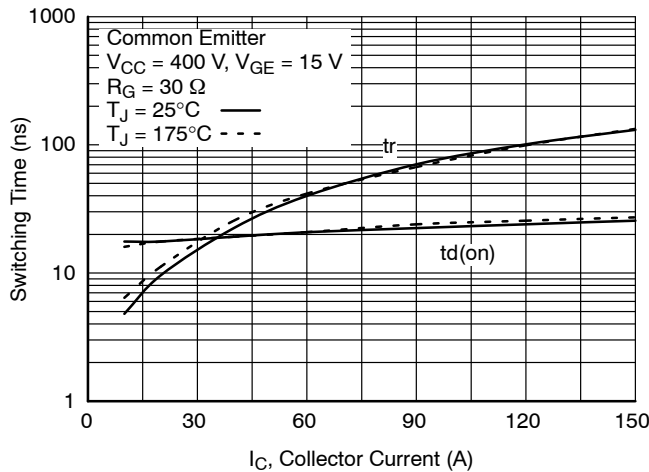

**Figure 11. Turn-on Characteristics vs. Collector Current**

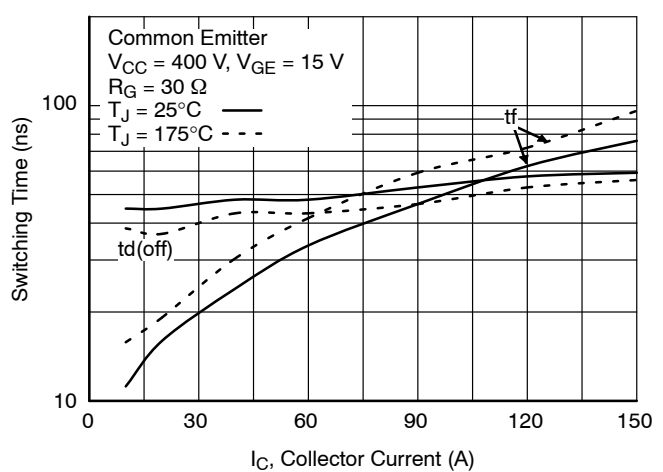

**Figure 12. Turn-off Characteristics vs. Collector Current**

# FGHL50T65MQDTL4

## TYPICAL CHARACTERISTICS (continued)

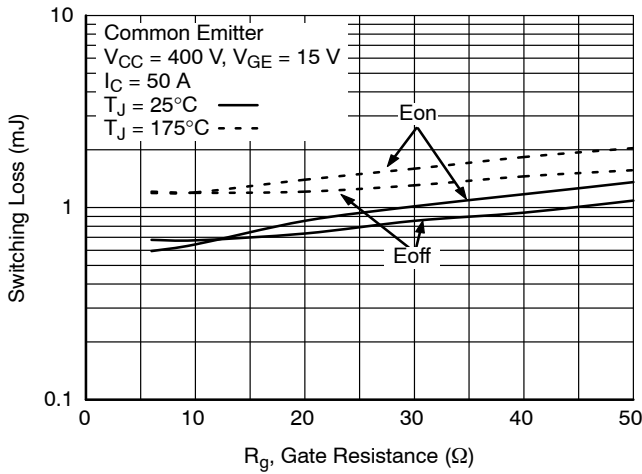

Figure 13. Switching Loss vs. Gate Resistance

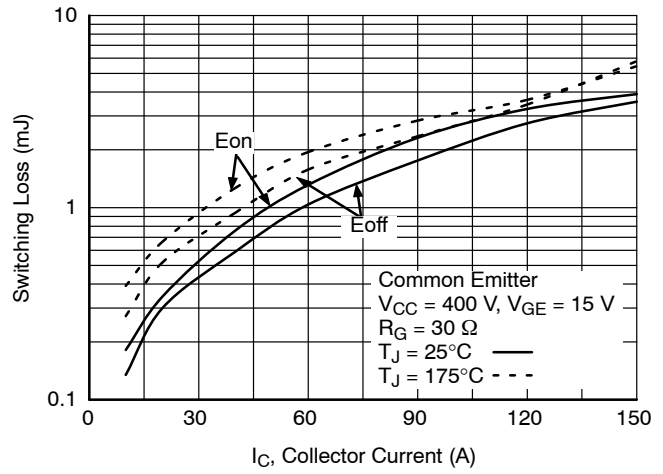

Figure 14. Switching Loss vs. Collector Current

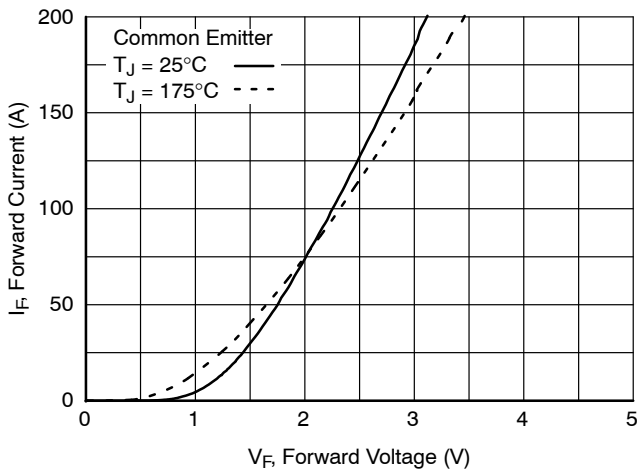

Figure 15. Forward Characteristics

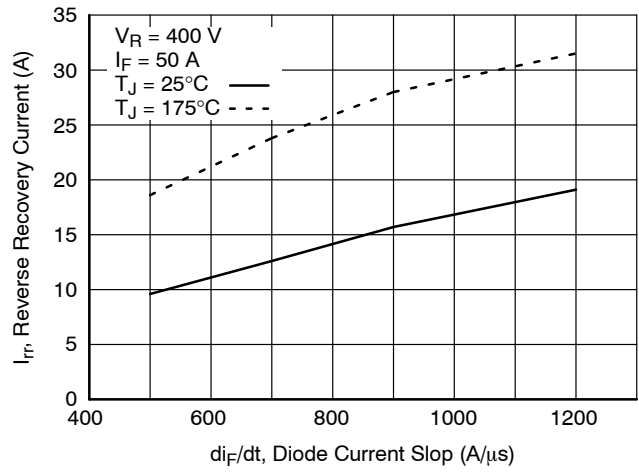

Figure 16. Reverse Recovery Current

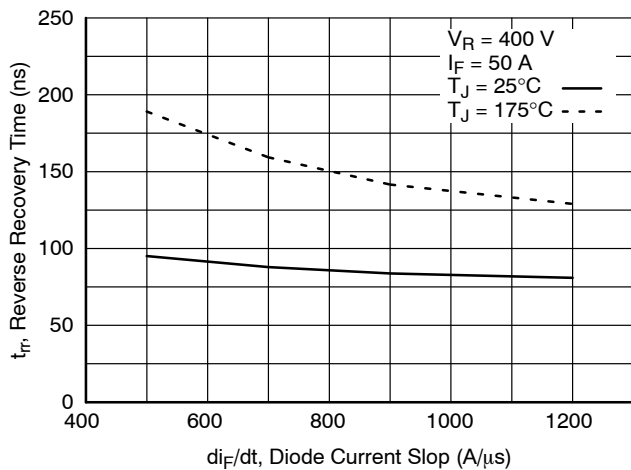

Figure 17. Reverse Recovery Time

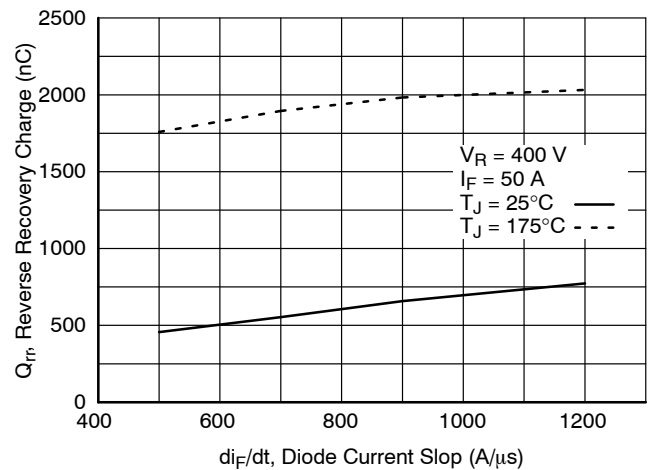

Figure 18. Stored Charge

# FGHL50T65MQDTL4

## TYPICAL CHARACTERISTICS (continued)

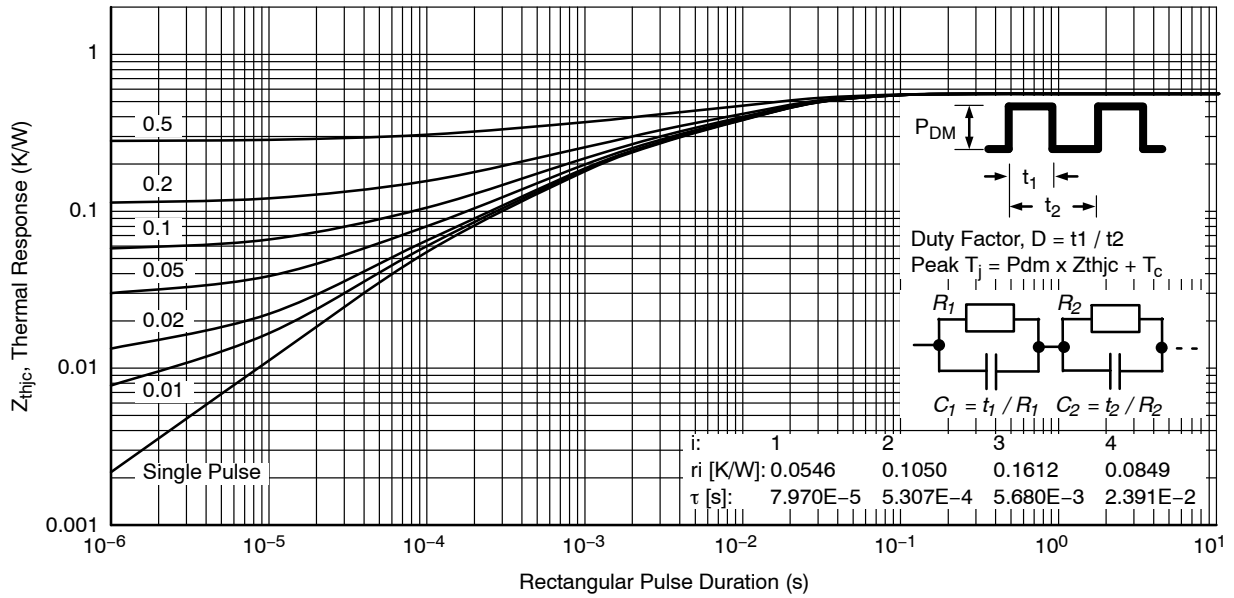

Figure 19. Transient Thermal Impedance of IGBT

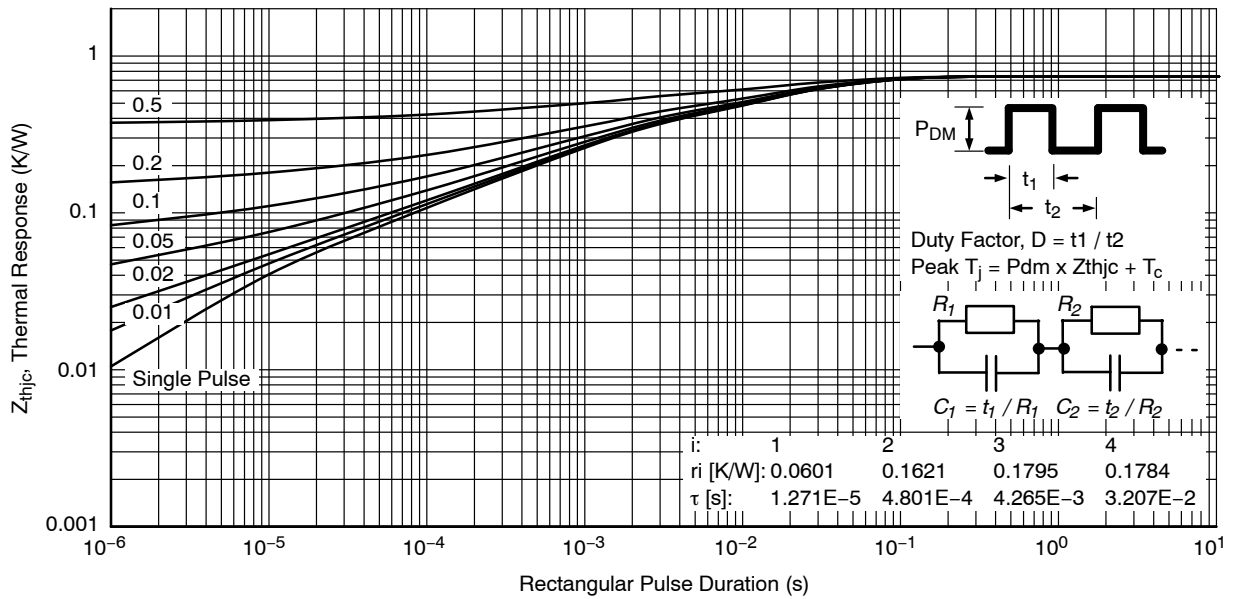
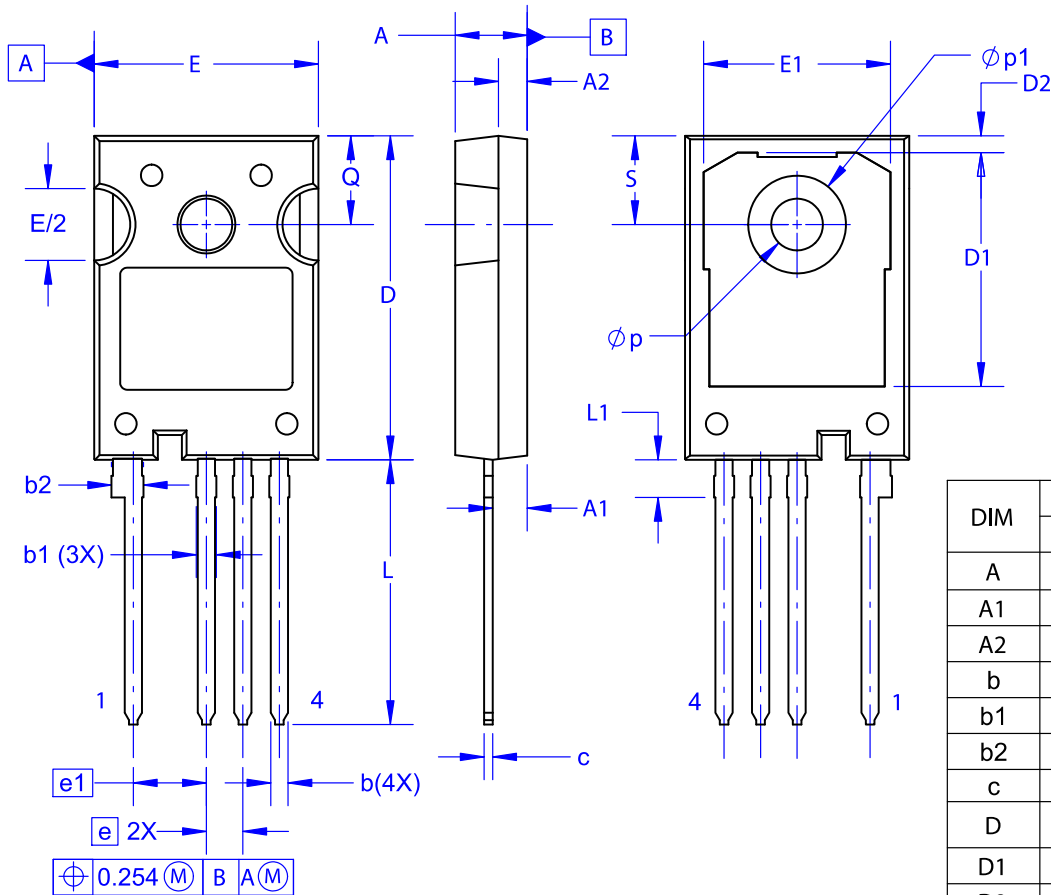

Figure 20. Transient Thermal Impedance of Diode

# FGHL50T65MQDTL4

## PACKAGE DIMENSIONS

TO-247-4LD  
CASE 340CJ  
ISSUE A



DIM	MILLIMETERS		
	MIN	NOM	MAX
A	4.80	5.00	5.20
A1	2.10	2.40	2.70
A2	1.80	2.00	2.20
b	1.07	1.20	1.33
b1	1.20	1.40	1.60
b2	2.02	2.22	2.42
c	0.50	0.60	0.70
D	22.34	22.54	22.74
D1	16.00	16.25	16.50
D2	0.97	1.17	1.37
e	2.54 BSC		
e1	5.08 BSC		
E	15.40	15.60	15.80
E1	12.80	13.00	13.20
E/2	4.80	5.00	5.20
L	18.22	18.42	18.62
L1	2.42	2.62	2.82
p	3.40	3.60	3.80
p1	6.60	6.80	7.00
Q	5.97	6.17	6.37
S	5.97	6.17	6.37

**NOTES:**

- A. NO INDUSTRY STANDARD APPLIES TO THIS PACKAGE.
- B. DIMENSIONS ARE EXCLUSIVE OF BURRS, MOLD FLASH, AND TIE BAR EXTRUSIONS.
- C. ALL DIMENSIONS ARE IN MILLIMETERS.
- D. DRAWING CONFORMS TO ASME Y14.5-2009.



ON Semiconductor and  are trademarks of Semiconductor Components Industries, LLC dba ON Semiconductor or its subsidiaries in the United States and/or other countries. ON Semiconductor owns the rights to a number of patents, trademarks, copyrights, trade secrets, and other intellectual property. A listing of ON Semiconductor's product/patent coverage may be accessed at [www.onsemi.com/site/pdf/Patent-Marking.pdf](http://www.onsemi.com/site/pdf/Patent-Marking.pdf). ON Semiconductor reserves the right to make changes without further notice to any products herein. ON Semiconductor makes no warranty, representation or guarantee regarding the suitability of its products for any particular purpose, nor does ON Semiconductor assume any liability arising out of the application or use of any product or circuit, and specifically disclaims any and all liability, including without limitation special, consequential or incidental damages. Buyer is responsible for its products and applications using ON Semiconductor products, including compliance with all laws, regulations and safety requirements or standards, regardless of any support or applications information provided by ON Semiconductor. "Typical" parameters which may be provided in ON Semiconductor data sheets and/or specifications can and do vary in different applications and actual performance may vary over time. All operating parameters, including "Typicals" must be validated for each customer application by customer's technical experts. ON Semiconductor does not convey any license under its patent rights nor the rights of others. ON Semiconductor products are not designed, intended, or authorized for use as a critical component in life support systems or any FDA Class 3 medical devices or medical devices with a same or similar classification in a foreign jurisdiction or any devices intended for implantation in the human body. Should Buyer purchase or use ON Semiconductor products for any such unintended or unauthorized application, Buyer shall indemnify and hold ON Semiconductor and its officers, employees, subsidiaries, affiliates, and distributors harmless against all claims, costs, damages, and expenses, and reasonable attorney fees arising out of, directly or indirectly, any claim of personal injury or death associated with such unintended or unauthorized use, even if such claim alleges that ON Semiconductor was negligent regarding the design or manufacture of the part. ON Semiconductor is an Equal Opportunity/Affirmative Action Employer. This literature is subject to all applicable copyright laws and is not for resale in any manner.

## PUBLICATION ORDERING INFORMATION

### LITERATURE FULFILLMENT:

Email Requests to: [orderlit@onsemi.com](mailto:orderlit@onsemi.com)

ON Semiconductor Website: [www.onsemi.com](http://www.onsemi.com)

### TECHNICAL SUPPORT

North American Technical Support:  
Voice Mail: 1 800-282-9855 Toll Free USA/Canada  
Phone: 011 421 33 790 2910

Europe, Middle East and Africa Technical Support:

Phone: 00421 33 790 2910

For additional information, please contact your local Sales Representative