



May 2014

# FGB3040G2\_F085 / FGD3040G2\_F085 FGP3040G2\_F085 / FGI3040G2\_F085

## EcoSPARK<sup>®</sup> 2 300mJ, 400V, N-Channel Ignition IGBT

### Features

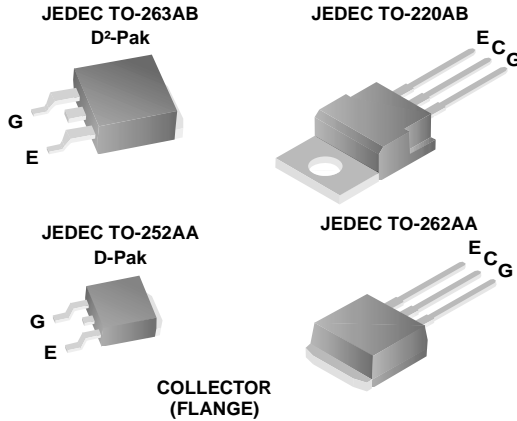
- SCIS Energy = 300mJ at  $T_J = 25^\circ\text{C}$
- Logic Level Gate Drive
- Qualified to AEC Q101
- RoHS Compliant

### Applications

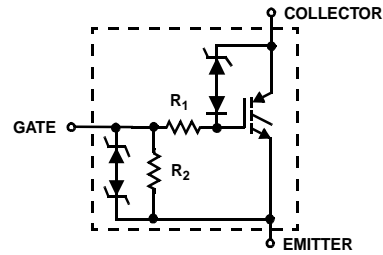
- Automotive Ignition Coil Driver Circuits
- Coil On Plug Applications



### Package



### Symbol



### Device Maximum Ratings $T_A = 25^\circ\text{C}$ unless otherwise noted

Symbol	Parameter	Rated	Units
$BV_{CER}$	Collector to Emitter Breakdown Voltage ( $I_C = 1\text{mA}$ )	400	V
$BV_{ECS}$	Emitter to Collector Voltage - Reverse Battery Condition ( $I_C = 10\text{mA}$ )	28	V
$E_{SCIS25}$	Self Clamping Inductive Switching Energy (Note 1)	300	mJ
$E_{SCIS150}$	Self Clamping Inductive Switching Energy (Note 2)	170	mJ
$I_{C25}$	Collector Current Continuous, at $V_{GE} = 5.0\text{V}$ , $T_C = 25^\circ\text{C}$	41	A
$I_{C110}$	Collector Current Continuous, at $V_{GE} = 5.0\text{V}$ , $T_C = 110^\circ\text{C}$	25.6	A
$V_{GEM}$	Gate to Emitter Voltage Continuous	$\pm 10$	V
$P_D$	Power Dissipation Total, at $T_C = 25^\circ\text{C}$	150	W
	Power Dissipation Derating, for $T_C > 25^\circ\text{C}$	1	W/ $^\circ\text{C}$
$T_J$	Operating Junction Temperature Range	-55 to +175	$^\circ\text{C}$
$T_{STG}$	Storage Junction Temperature Range	-55 to +175	$^\circ\text{C}$
$T_L$	Max. Lead Temp. for Soldering (Leads at 1.6mm from case for 10s)	300	$^\circ\text{C}$
$T_{PKG}$	Reflow soldering according to JESD020C	260	$^\circ\text{C}$
ESD	HBM-Electrostatic Discharge Voltage at 100pF, 1500 $\Omega$	4	kV
	CDM-Electrostatic Discharge Voltage at 1 $\Omega$	2	kV

FGB3040G2\_F085 / FGD3040G2\_F085 / FGP3040G2\_F085 / FGI3040G2\_F085

## Package Marking and Ordering Information

Device Marking	Device	Package	Reel Size	Tape Width	Quantity
FGB3040G2	FGB3040G2_F085	TO-263AB	330mm	24mm	800
FGD3040G2	FGD3040G2_F085	TO-252AA	330mm	16mm	2500
FGP3040G2	FGP3040G2_F085	TO-220AB	Tube	N/A	50
FGI3040G2	FGI3040G2_F085	TO-262AA	Tube	N/A	50

## Electrical Characteristics $T_A = 25^\circ\text{C}$ unless otherwise noted

Symbol	Parameter	Test Conditions	Min	Typ	Max	Units
--------	-----------	-----------------	-----	-----	-----	-------

### Off State Characteristics

$BV_{\text{CER}}$	Collector to Emitter Breakdown Voltage	$I_{\text{CE}} = 2\text{mA}, V_{\text{GE}} = 0,$ $R_{\text{GE}} = 1\text{K}\Omega,$ $T_J = -40 \text{ to } 150^\circ\text{C}$	370	400	430	V	
$BV_{\text{CES}}$	Collector to Emitter Breakdown Voltage	$I_{\text{CE}} = 10\text{mA}, V_{\text{GE}} = 0\text{V},$ $R_{\text{GE}} = 0,$ $T_J = -40 \text{ to } 150^\circ\text{C}$	390	420	450	V	
$BV_{\text{ECS}}$	Emitter to Collector Breakdown Voltage	$I_{\text{CE}} = -20\text{mA}, V_{\text{GE}} = 0\text{V},$ $T_J = 25^\circ\text{C}$	28	-	-	V	
$BV_{\text{GES}}$	Gate to Emitter Breakdown Voltage	$I_{\text{GES}} = \pm 2\text{mA}$	$\pm 12$	$\pm 14$	-	V	
$I_{\text{CER}}$	Collector to Emitter Leakage Current	$V_{\text{CE}} = 250\text{V}, R_{\text{GE}} = 1\text{K}\Omega$	$T_J = 25^\circ\text{C}$	-	-	25	$\mu\text{A}$
			$T_J = 150^\circ\text{C}$	-	-	1	mA
$I_{\text{ECS}}$	Emitter to Collector Leakage Current	$V_{\text{EC}} = 24\text{V},$	$T_J = 25^\circ\text{C}$	-	-	1	mA
			$T_J = 150^\circ\text{C}$	-	-	40	mA
$R_1$	Series Gate Resistance		-	120	-	$\Omega$	
$R_2$	Gate to Emitter Resistance		10K	-	30K	$\Omega$	

### On State Characteristics

$V_{\text{CE(SAT)}}$	Collector to Emitter Saturation Voltage	$I_{\text{CE}} = 6\text{A}, V_{\text{GE}} = 4\text{V},$	$T_J = 25^\circ\text{C}$	-	1.15	1.25	V
$V_{\text{CE(SAT)}}$	Collector to Emitter Saturation Voltage	$I_{\text{CE}} = 10\text{A}, V_{\text{GE}} = 4.5\text{V},$	$T_J = 150^\circ\text{C}$	-	1.35	1.50	V
$V_{\text{CE(SAT)}}$	Collector to Emitter Saturation Voltage	$I_{\text{CE}} = 15\text{A}, V_{\text{GE}} = 4.5\text{V},$	$T_J = 150^\circ\text{C}$	-	1.68	1.85	V
$E_{\text{SCIS}}$	Self Clamped Inductive Switching	$L = 3.0 \text{ mHy}, R_G = 1\text{K}\Omega,$ $V_{\text{GE}} = 5\text{V}, (\text{Note } 1)$	$T_J = 25^\circ\text{C}$	-	-	300	mJ

### Thermal Characteristics

$R_{\theta\text{JC}}$	Thermal Resistance Junction to Case		-	-	1	$^\circ\text{C/W}$
-----------------------	-------------------------------------	--	---	---	---	--------------------

### Notes:

1: Self Clamping Inductive Switching Energy ( $E_{\text{SCIS}25}$ ) of 300 mJ is based on the test conditions that starting  $T_J = 25^\circ\text{C}$ ;  $L = 3\text{mHy}$ ,  $I_{\text{SCIS}} = 14.2\text{A}$ ,  $V_{\text{CC}} = 100\text{V}$  during inductor charging and  $V_{\text{CC}} = 0\text{V}$  during the time in clamp.

2: Self Clamping Inductive Switching Energy ( $E_{\text{SCIS}150}$ ) of 170 mJ is based on the test conditions that starting  $T_J = 150^\circ\text{C}$ ;  $L = 3\text{mHy}$ ,  $I_{\text{SCIS}} = 10.8\text{A}$ ,  $V_{\text{CC}} = 100\text{V}$  during inductor charging and  $V_{\text{CC}} = 0\text{V}$  during the time in clamp.

**Electrical Characteristics**  $T_A = 25^\circ\text{C}$  unless otherwise noted

Symbol	Parameter	Test Conditions	Min	Typ	Max	Units
--------	-----------	-----------------	-----	-----	-----	-------

**Dynamic Characteristics**

$Q_{G(ON)}$	Gate Charge	$I_{CE} = 10\text{A}, V_{CE} = 12\text{V}, V_{GE} = 5\text{V}$	-	21	-	nC
$V_{GE(TH)}$	Gate to Emitter Threshold Voltage	$I_{CE} = 1\text{mA}, V_{CE} = V_{GE}, T_J = 25^\circ\text{C}$	1.3	1.7	2.2	V
		$T_J = 150^\circ\text{C}$	0.75	1.2	1.8	
$V_{GEP}$	Gate to Emitter Plateau Voltage	$V_{CE} = 12\text{V}, I_{CE} = 10\text{A}$	-	2.8	-	V

**Switching Characteristics**

$t_{d(ON)R}$	Current Turn-On Delay Time-Resistive	$V_{CE} = 14\text{V}, R_L = 1\Omega$	-	0.9	4	$\mu\text{s}$
$t_{rR}$	Current Rise Time-Resistive	$V_{GE} = 5\text{V}, R_G = 1\text{K}\Omega, T_J = 25^\circ\text{C}$	-	1.9	7	
$t_{d(OFF)L}$	Current Turn-Off Delay Time-Inductive	$V_{CE} = 300\text{V}, L = 1\text{mH}, V_{GE} = 5\text{V}, R_G = 1\text{K}\Omega$	-	4.8	15	$\mu\text{s}$
$t_{fL}$	Current Fall Time-Inductive	$I_{CE} = 6.5\text{A}, T_J = 25^\circ\text{C}$	-	2.0	15	

## Typical Performance Curves

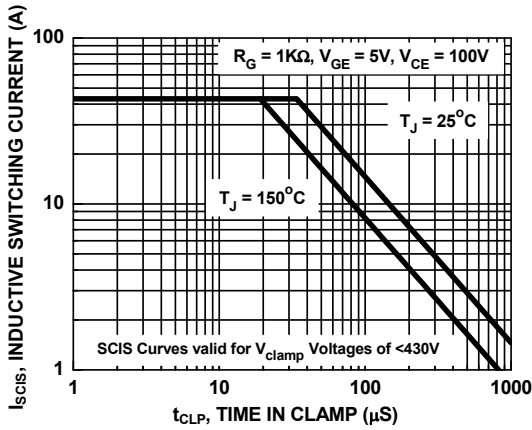


Figure 1. Self Clamped Inductive Switching Current vs. Time in Clamp

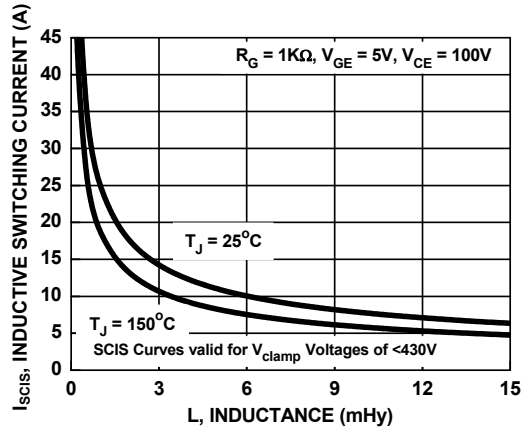


Figure 2. Self Clamped Inductive Switching Current vs. Inductance

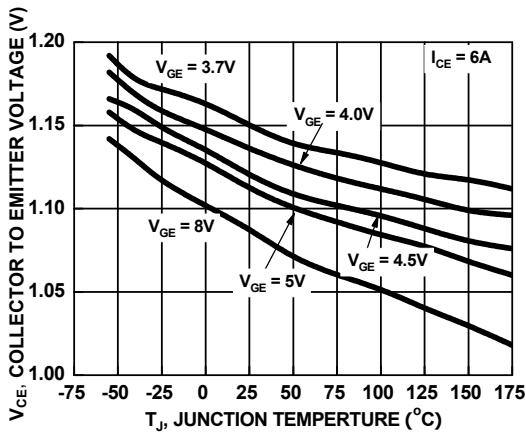


Figure 3. Collector to Emitter On-State Voltage vs. Junction Temperature

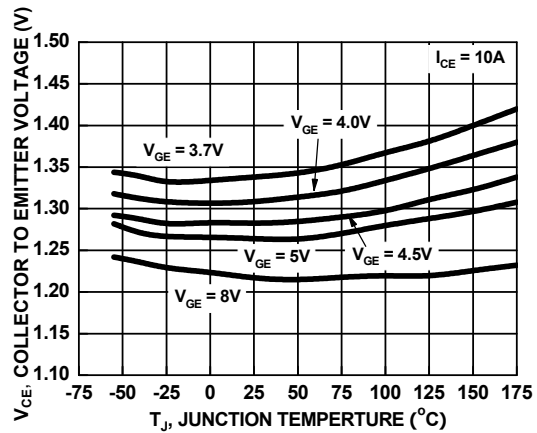


Figure 4. Collector to Emitter On-State Voltage vs. Junction Temperature

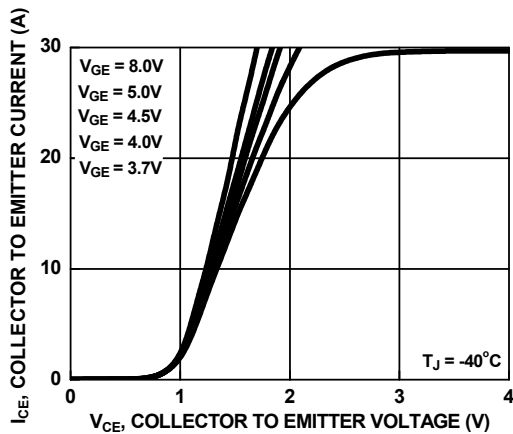


Figure 5. Collector to Emitter On-State Voltage vs. Collector Current

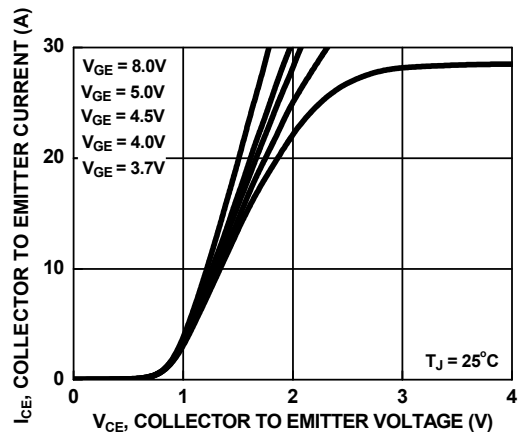


Figure 6. Collector to Emitter On-State Voltage vs. Collector Current

Typical Performance Curves (Continued)

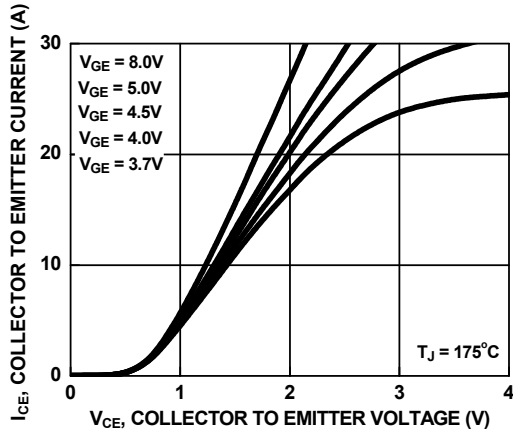


Figure 7. Collector to Emitter On-State Voltage vs. Collector Current

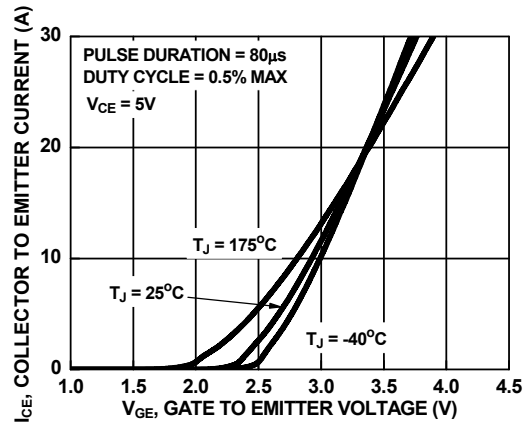


Figure 8. Transfer Characteristics

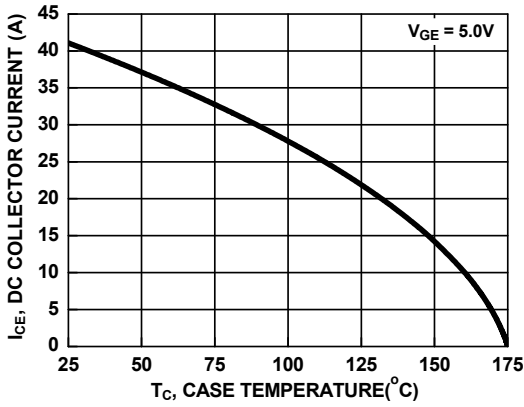


Figure 9. DC Collector Current vs. Case Temperature

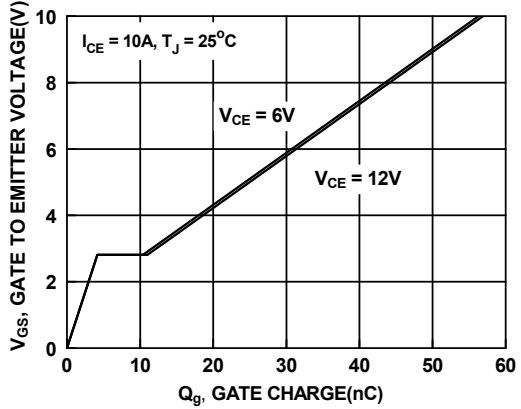


Figure 10. Gate Charge

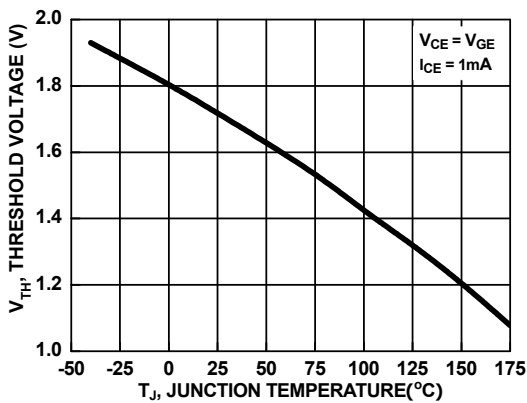


Figure 11. Threshold Voltage vs. Junction Temperature

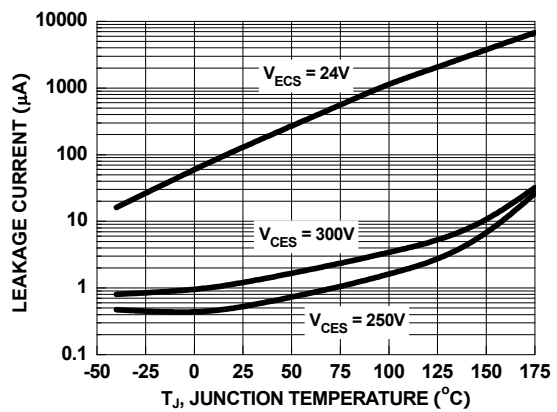
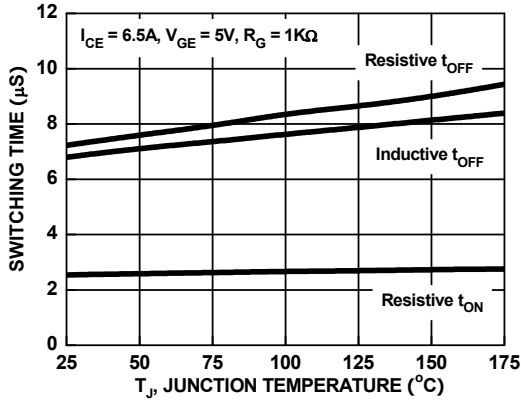
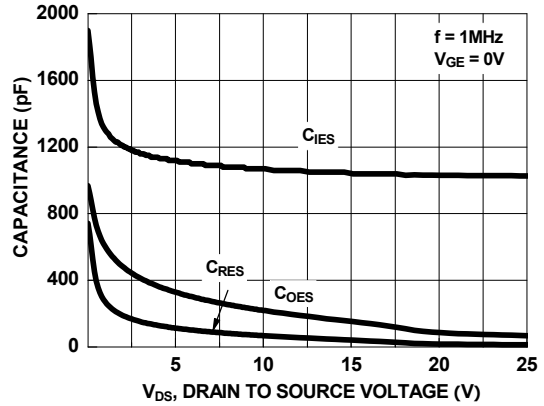


Figure 12. Leakage Current vs. Junction Temperature

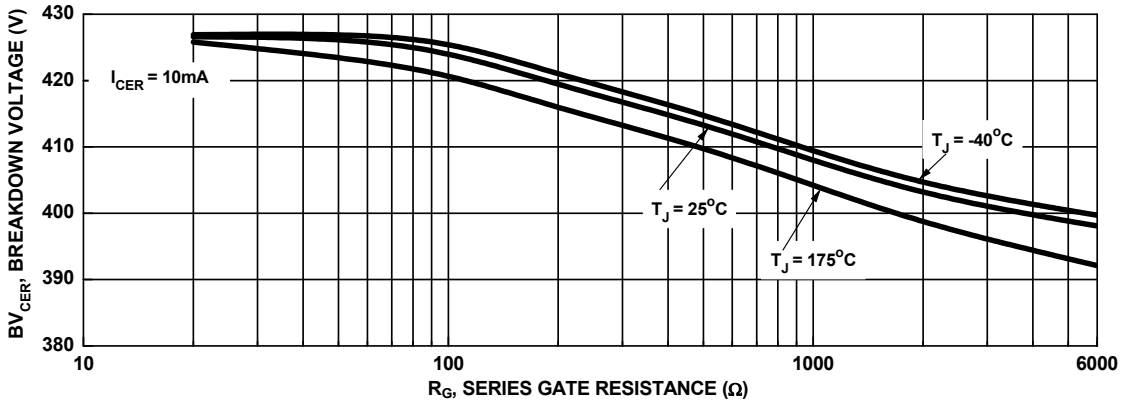
**Typical Performance Curves** (Continued)



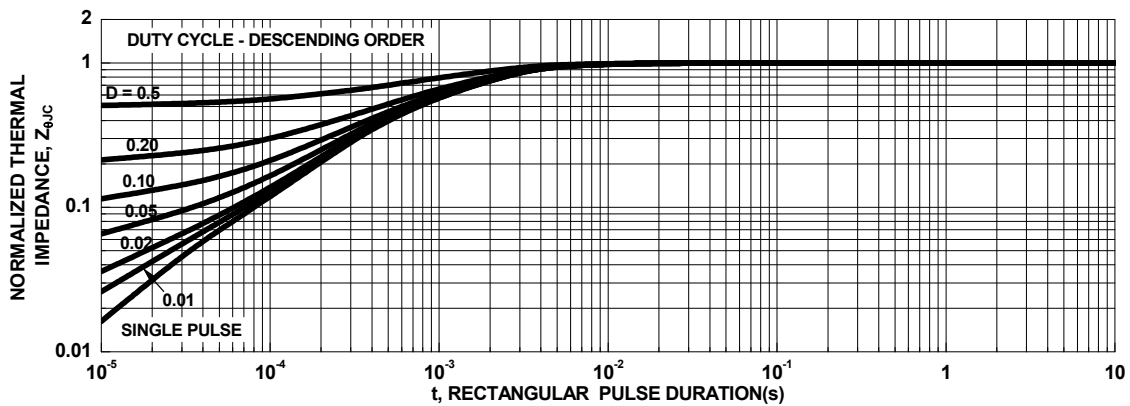
**Figure 13. Switching Time vs. Junction Temperature**



**Figure 14. Capacitance vs. Collector to Emitter Voltage**

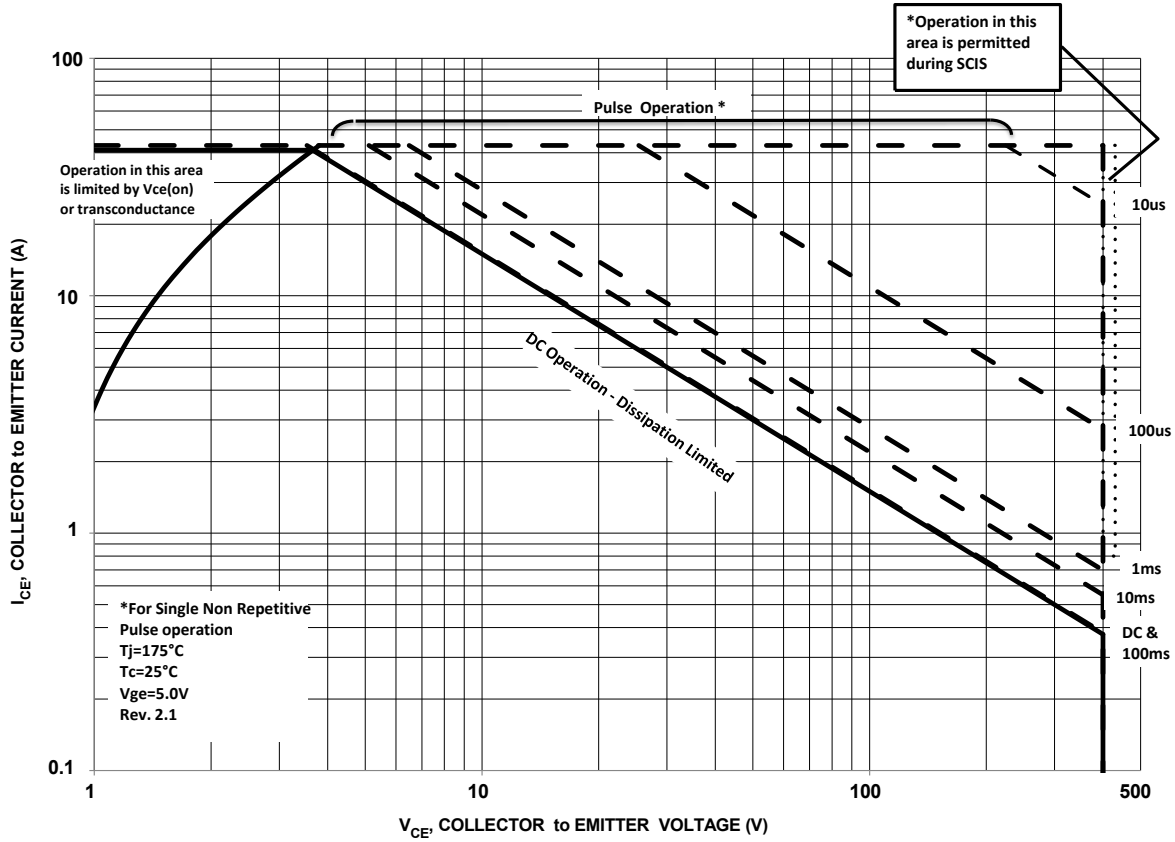


**Figure 15. Break down Voltage vs. Series Gate Resistance**

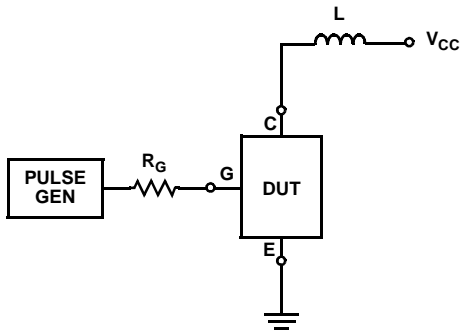


**Figure 16. IGBT Normalized Transient Thermal Impedance, Junction to Case**

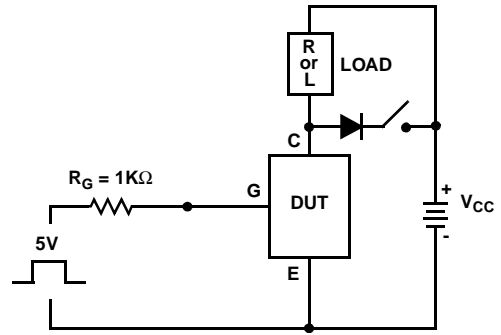
### Typical Performance Curves



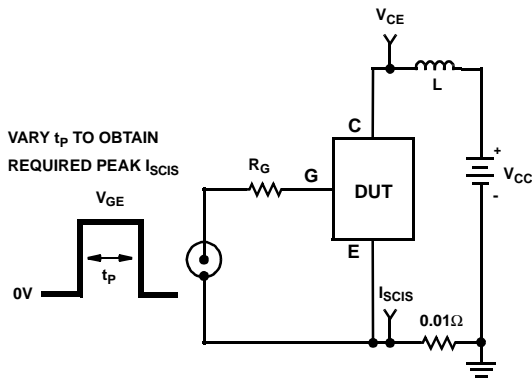
**Test Circuit and Waveforms**



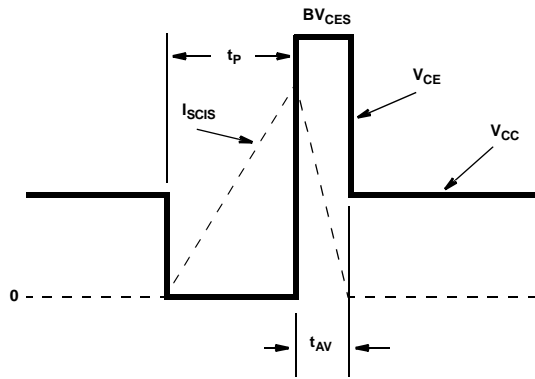
**Figure 18. Inductive Switching Test Circuit**



**Figure 19.  $t_{ON}$  and  $t_{OFF}$  Switching Test Circuit**



**Figure 20. Energy Test Circuit**








**Figure 21. Energy Waveforms**





**TRADEMARKS**

The following includes registered and unregistered trademarks and service marks, owned by Fairchild Semiconductor and/or its global subsidiaries, and is not intended to be an exhaustive list of all such trademarks.

- |   |   |   |   |
|---|---|---|---|
| AccuPower™  | F-PFS™  |  ® |  SYSTEM® |
| AX-CAP®*  | FRFET®  | PowerTrench®  | TinyBoost®  |
| BitSiC™   | Global Power ResourceSM                         | PowerXS™  | TinyBuck®   |
| Build it Now™   | GreenBridge™                                    | Programmable Active Droop™  | TinyCalc™   |
| CorePLUS™   | Green FPS™                                      | QFET®   | TinyLogic®  |
| CorePOWER™  | Green FPS™ e-Series™                            | QS™   | TINYOPTO™   |
| CROSSVOL™   | Gmax™   | Quiet Series™   | TinyPower™  |
| CTL™  | GTO™  | RapidConfigure™   | TinyPWM™  |
| Current Transfer Logic™   | IntelliMAX™                                     |  ™ | TinyWire™   |
| DEUXPEED®   | ISOPLANAR™                                      | Saving our world, 1mW/W/kW at a time™   | TranSiC™  |
| Dual Cool™  | Marking Small Speakers Sound Louder and Better™ | SignalWise™   | TriFault Detect™  |
| EcoSPARK®   | MegaBuck™                                       | SmartMax™   | TRUECURRENT®*   |
| EfficientMax™   | MICROCOUPLER™                                   | SMART START™  | µSerDes™  |
| ESBC™   | MicroFET™                                       | Solutions for Your Success™   |  SerDes™ |
|  ® | MicroPak™                                       | SPM®  | UHC®  |
| Fairchild®  | MicroPak2™                                      | STEALTH™  | Ultra FRFET™  |
| Fairchild Semiconductor®  | MillerDrive™                                    | SuperFET®   | UniFET™   |
| FACT Quiet Series™  | MotionMax™                                      | SuperSOT™-3   | VCX™  |
| FACT®   | mWSaver®  | SuperSOT™-6   | VisualMax™  |
| FAST®   | OptoHit™  | SuperSOT™-8   | VoltagePlus™  |
| FastvCore™  | OPTOLOGIC®                                      | SupreMOS®   | XST™  |
| FETBench™   | OPTOPLANAR®                                     | SyncFET™  | 仙童™   |
| FPS™  |   | Sync-Lock™  |   |

\*Trademarks of System General Corporation, used under license by Fairchild Semiconductor.

**DISCLAIMER**

FAIRCHILD SEMICONDUCTOR RESERVES THE RIGHT TO MAKE CHANGES WITHOUT FURTHER NOTICE TO ANY PRODUCTS HEREIN TO IMPROVE RELIABILITY, FUNCTION, OR DESIGN. FAIRCHILD DOES NOT ASSUME ANY LIABILITY ARISING OUT OF THE APPLICATION OR USE OF ANY PRODUCT OR CIRCUIT DESCRIBED HEREIN; NEITHER DOES IT CONVEY ANY LICENSE UNDER ITS PATENT RIGHTS, NOR THE RIGHTS OF OTHERS. THESE SPECIFICATIONS DO NOT EXPAND THE TERMS OF FAIRCHILD'S WORLDWIDE TERMS AND CONDITIONS, SPECIFICALLY THE WARRANTY THEREIN, WHICH COVERS THESE PRODUCTS.

**LIFE SUPPORT POLICY**

FAIRCHILD'S PRODUCTS ARE NOT AUTHORIZED FOR USE AS CRITICAL COMPONENTS IN LIFE SUPPORT DEVICES OR SYSTEMS WITHOUT THE EXPRESS WRITTEN APPROVAL OF FAIRCHILD SEMICONDUCTOR CORPORATION.

As used here in:

- Life support devices or systems are devices or systems which, (a) are intended for surgical implant into the body or (b) support or sustain life, and (c) whose failure to perform when properly used in accordance with instructions for use provided in the labeling, can be reasonably expected to result in a significant injury of the user.
- A critical component in any component of a life support, device, or system whose failure to perform can be reasonably expected to cause the failure of the life support device or system, or to affect its safety or effectiveness.

**ANTI-COUNTERFEITING POLICY**

Fairchild Semiconductor Corporation's Anti-Counterfeiting Policy. Fairchild's Anti-Counterfeiting Policy is also stated on our external website, www.Fairchildsemi.com, under Sales Support.

Counterfeiting of semiconductor parts is a growing problem in the industry. All manufactures of semiconductor products are experiencing counterfeiting of their parts. Customers who inadvertently purchase counterfeit parts experience many problems such as loss of brand reputation, substandard performance, failed application, and increased cost of production and manufacturing delays. Fairchild is taking strong measures to protect ourselves and our customers from the proliferation of counterfeit parts. Fairchild strongly encourages customers to purchase Fairchild parts either directly from Fairchild or from Authorized Fairchild Distributors who are listed by country on our web page cited above. Products customers buy either from Fairchild directly or from Authorized Fairchild Distributors are genuine parts, have full traceability, meet Fairchild's quality standards for handling and storage and provide access to Fairchild's full range of up-to-date technical and product information. Fairchild and our Authorized Distributors will stand behind all warranties and will appropriately address and warranty issues that may arise. Fairchild will not provide any warranty coverage or other assistance for parts bought from Unauthorized Sources. Fairchild is committed to combat this global problem and encourage our customers to do their part in stopping this practice by buying direct or from authorized distributors.

**PRODUCT STATUS DEFINITIONS**

**Definition of Terms**

Datasheet Identification	Product Status	Definition
Advance Information	Formative / In Design	Datasheet contains the design specifications for product development. Specifications may change in any manner without notice.
Preliminary	First Production	Datasheet contains preliminary data; supplementary data will be published at a later date. Fairchild Semiconductor reserves the right to make changes at any time without notice to improve design.
No Identification Needed	Full Production	Datasheet contains final specifications. Fairchild Semiconductor reserves the right to make changes at any time without notice to improve the design.
Obsolete	Not In Production	Datasheet contains specifications on a product that is discontinued by Fairchild Semiconductor. The datasheet is for reference information only.

ON Semiconductor and  are trademarks of Semiconductor Components Industries, LLC dba ON Semiconductor or its subsidiaries in the United States and/or other countries. ON Semiconductor owns the rights to a number of patents, trademarks, copyrights, trade secrets, and other intellectual property. A listing of ON Semiconductor's product/patent coverage may be accessed at [www.onsemi.com/site/pdf/Patent-Marking.pdf](http://www.onsemi.com/site/pdf/Patent-Marking.pdf). ON Semiconductor reserves the right to make changes without further notice to any products herein. ON Semiconductor makes no warranty, representation or guarantee regarding the suitability of its products for any particular purpose, nor does ON Semiconductor assume any liability arising out of the application or use of any product or circuit, and specifically disclaims any and all liability, including without limitation special, consequential or incidental damages. Buyer is responsible for its products and applications using ON Semiconductor products, including compliance with all laws, regulations and safety requirements or standards, regardless of any support or applications information provided by ON Semiconductor. "Typical" parameters which may be provided in ON Semiconductor data sheets and/or specifications can and do vary in different applications and actual performance may vary over time. All operating parameters, including "Typicals" must be validated for each customer application by customer's technical experts. ON Semiconductor does not convey any license under its patent rights nor the rights of others. ON Semiconductor products are not designed, intended, or authorized for use as a critical component in life support systems or any FDA Class 3 medical devices or medical devices with a same or similar classification in a foreign jurisdiction or any devices intended for implantation in the human body. Should Buyer purchase or use ON Semiconductor products for any such unintended or unauthorized application, Buyer shall indemnify and hold ON Semiconductor and its officers, employees, subsidiaries, affiliates, and distributors harmless against all claims, costs, damages, and expenses, and reasonable attorney fees arising out of, directly or indirectly, any claim of personal injury or death associated with such unintended or unauthorized use, even if such claim alleges that ON Semiconductor was negligent regarding the design or manufacture of the part. ON Semiconductor is an Equal Opportunity/Affirmative Action Employer. This literature is subject to all applicable copyright laws and is not for resale in any manner.

## PUBLICATION ORDERING INFORMATION

### LITERATURE FULFILLMENT:

Literature Distribution Center for ON Semiconductor  
19521 E. 32nd Pkwy, Aurora, Colorado 80011 USA  
**Phone:** 303-675-2175 or 800-344-3860 Toll Free USA/Canada  
**Fax:** 303-675-2176 or 800-344-3867 Toll Free USA/Canada  
**Email:** [orderlit@onsemi.com](mailto:orderlit@onsemi.com)

**N. American Technical Support:** 800-282-9855 Toll Free  
USA/Canada  
**Europe, Middle East and Africa Technical Support:**  
Phone: 421 33 790 2910  
**Japan Customer Focus Center**  
Phone: 81-3-5817-1050

**ON Semiconductor Website:** [www.onsemi.com](http://www.onsemi.com)  
**Order Literature:** <http://www.onsemi.com/orderlit>  
For additional information, please contact your local  
Sales Representative