

# 3.3 V LVDS High Speed Differential Driver/Receiver

## FIN1019



### General Description

This driver and receiver pair are designed for high speed interconnects utilizing Low Voltage Differential Signaling (LVDS) technology. The driver translates LVTTTL signals to LVDS levels with a typical differential output swing of 350 mV and the receiver translates LVDS signals, with a typical differential input threshold of 100 mV, into LVTTTL levels. LVDS technology provides low EMI at ultra low power dissipation even at high frequencies. This device is ideal for high speed clock or data transfer.

### Features

- Greater than 400 Mbs Data Rate
- 3.3 V Power Supply Operation
- 0.5 ns Maximum Differential Pulse Skew
- 2.5 ns Maximum Propagation Delay
- Low Power Dissipation
- Power-Off Protection
- 100 mV Receiver Input Sensitivity
- Fail Safe Protection Open-circuit, Shorted and Terminated Conditions
- Meets or Exceeds the TIA/EIA-644 LVDS Standard
- Flow-through Pinout Simplifies PCB Layout
- 14-Lead TSSOP Package Save Space
- This Device is Pb-Free, Halide Free and is RoHS Compliant

### FUNCTION TABLE

R <sub>IN+</sub>	R <sub>IN-</sub>	RE	R <sub>OUT</sub>
L	H	L	L
H	L	L	H
X	X	H	Z
Fail Safe Condition		L	H
D <sub>IN</sub>	DE	D <sub>OUT+</sub>	D <sub>OUT-</sub>
L	H	L	H
H	H	H	L
X	L	Z	Z
Open-Circuit or Z		H	H

H = HIGH Logic Level  
Z = High Impedance  
L = LOW Logic Level  
Fail Safe = Open, Shorted, Terminated  
X = Don't Care

### MARKING DIAGRAM

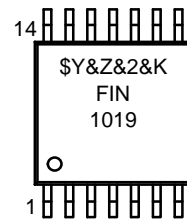

\$Y = Logo  
&Z = Assembly Plant Code  
&2 = 2-Digit Date Code  
&K = 2-Digits Lot Run Traceability Code  
FIN1019 = Specific Device Code

### CONNECTION DIAGRAM

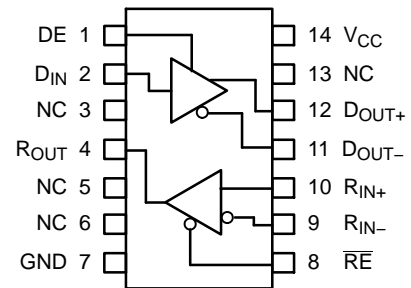

### ORDERING INFORMATION

Order Number	Package	Shipping†
FIN1019MTCX	TSSOP-14 WB (Pb-Free)	2500 / Tape & Reel

†For information on tape and reel specifications, including part orientation and tape sizes, please refer to our Tape and Reel Packaging Specifications Brochure, BRD8011/D.

**PIN DESCRIPTIONS**

Pin Name	Description
D <sub>IN</sub>	LVTTTL Data Input
D <sub>OUT+</sub>	Non-inverting LVDS Output
D <sub>OUT-</sub>	Inverting LVDS Output
DE	Driver Enable (LVTTTL, Active HIGH)
R <sub>IN+</sub>	Non-Inverting LVDS Input
R <sub>IN-</sub>	Inverting LVDS Input
R <sub>OUT</sub>	LVTTTL Receiver Output
$\overline{RE}$	Receiver Enable (LVTTTL, Active LOW)
V <sub>CC</sub>	Power Supply
GND	Ground
NC	No Connect

**ABSOLUTE MAXIMUM RATINGS**

Symbol	Parameter	Rating
V <sub>CC</sub>	Supply Voltage	-0.5 V to +4.6 V
D <sub>IN</sub> , DE, $\overline{RE}$	LVTTTL DC Input Voltage	-0.5 V to +6 V
R <sub>IN+</sub> , R <sub>IN-</sub>	LVDS DC Input Voltage	-0.5 V to 4.7 V
R <sub>OUT</sub>	LVTTTL DC Output Voltage	-0.5 V to +6 V
D <sub>OUT+</sub> , D <sub>OUT-</sub>	LVDS DC Output Voltage	-0.5 V to 4.7 V
I <sub>OSD</sub>	LVDS Driver Short Circuit Current	Continuous
I <sub>O</sub>	LVTTTL DC Output Current	16 mA
T <sub>STG</sub>	Storage Temperature Range	-65°C to +150°C
T <sub>J</sub>	Max Junction Temperature	150°C
T <sub>L</sub>	Lead Temperature (Soldering, 10 Seconds)	260°C
	ESD (Human Body Model)	≥6500 V
	ESD (Machine Model)	≥300 V

Stresses exceeding those listed in the Maximum Ratings table may damage the device. If any of these limits are exceeded, device functionality should not be assumed, damage may occur and reliability may be affected.

**RECOMMENDED OPERATING CONDITIONS**

Symbol	Parameter	Value
V <sub>CC</sub>	Supply Voltage	3.0 V to 3.6 V
V <sub>IN</sub>	Input Voltage	0 to V <sub>CC</sub>
V <sub>ID</sub>	Magnitude of Differential Voltage	100 mV to V <sub>CC</sub>
V <sub>IC</sub>	Common-Mode Input Voltage	0.05 V to 2.35 V
T <sub>A</sub>	Operating Temperature	-40°C to +85°C

Functional operation above the stresses listed in the Recommended Operating Ranges is not implied. Extended exposure to stresses beyond the Recommended Operating Ranges limits may affect device reliability.

# FIN1019

## DC ELECTRICAL CHARACTERISTICS (Over supply voltage and operating temperature ranges, unless otherwise specified)

Symbol	Parameter	Test Conditions	Min	Typ (Note 1)	Max	Unit
--------	-----------	-----------------	-----	--------------	-----	------

### LVDS DIFFERENTIAL DRIVER CHARACTERISTICS

$V_{OD}$	Output Differential Voltage	$R_L = 100 \Omega$ , See Figure 1	250	350	450	mV
$\Delta V_{OD}$	$V_{OD}$ Magnitude Change from Differential LOW-to-HIGH		-	-	25	mV
$V_{OS}$	Offset Voltage		1.125	1.25	1.375	V
$\Delta V_{OS}$	Offset Magnitude Change from Differential LOW-to-HIGH		-	-	25	mV
$I_{OZD}$	Disabled Output Leakage Current	$V_{OUT} = V_{CC}$ or GND, $DE = 0 V$	-	-	$\pm 20$	$\mu A$
$I_{OFF}$	Power Off Output Current	$V_{CC} = 0 V$ , $V_{OUT} = 0 V$ or $3.6 V$	-	-	$\pm 20$	$\mu A$
$I_{OS}$	Short Circuit Output Current	$V_{OUT} = 0 V$ , $DE = V_{CC}$	-	-	-8	mA
		$V_{OD} = 0 V$ , $DE = V_{CC}$	-	-	$\pm 8$	

### LVTTTL DRIVER CHARACTERISTICS

$V_{OH}$	Output HIGH Voltage	$I_{OH} = -100 \mu A$ , $\overline{RE} = 0 V$ , See Figure 6 and Table 1	$V_{CC} - 0.2$	-	-	V
		$I_{OH} = -8 mA$ , $\overline{RE} = 0 V$ , $V_{ID} = 400 mV$ $V_{ID} = 400 mV$ , $V_{IC} = 1.2 V$ , see Figure 6	2.4	-	-	
$V_{OL}$	Output LOW Voltage	$I_{OL} = 100 \mu A$ , $\overline{RE} = 0 V$ , $V_{ID} = -400 mV$ See Figure 6 and Table 1	-	-	0.2	V
		$I_{OL} = -8 mA$ , $\overline{RE} = 0 V$ , $V_{ID} = -400 mV$ $V_{ID} = -400 mV$ , $V_{IC} = 1.2 V$ , see Figure 6	-	-	0.5	
$I_{OZ}$	Disabled Output Leakage Current	$V_{OUT} = V_{CC}$ or GND, $\overline{RE} = V_{CC}$	-	-	$\pm 20$	$\mu A$

### LVDS RECEIVER CHARACTERISTICS

$V_{TH}$	Differential Input Threshold HIGH	See Figure 6 and Table 1	-	-	100	mV
$V_{TL}$	Differential Input Threshold LOW	See Figure 6 and Table 1	-100	-	-	mV
$I_{IN}$	Input Current	$V_{IN} = 0 V$ or $V_{CC}$	-	-	$\pm 20$	$\mu A$
$I_{I(OFF)}$	Power-OFF Input Current	$V_{CC} = 0 V$ , $V_{IN} = 0 V$ or $3.6 V$	-	-	$\pm 20$	$\mu A$

### LVTTTL DRIVER AND CONTROL SIGNALS CHARACTERISTICS

$V_{IH}$	Input HIGH Voltage		2.0	-	$V_{CC}$	V
$V_{IL}$	Input LOW Voltage		GND	-	0.8	V
$I_{IN}$	Input Current	$V_{IN} = 0 V$ or $V_{CC}$	-	-	$\pm 20$	$\mu A$
$I_{I(OFF)}$	Power-OFF Input Current	$V_{CC} = 0 V$ , $V_{IN} = 0 V$ or $3.6 V$	-	-	$\pm 20$	$\mu A$
$V_{IK}$	Input Clamp Voltage	$I_{IK} = -18 mA$	-1.5	-	-	V

### DEVICE CHARACTERISTICS

$I_{CC}$	Power Supply Current	Driver Enabled, Driver Load: $R_L = 100 \Omega$ Receiver Disabled, No Receiver Load	-	-	12.5	mA
		Driver Enabled, Driver Load: $R_L = 100 \Omega$ , Receiver Enabled, ( $R_{IN+} = 1 V$ and $R_{IN-} = 1.4 V$ ) or ( $R_{IN+} = 1.4 V$ and $R_{OUT-} = 1 V$ )	-	-	12.5	
		Driver Disabled, Receiver Enabled, ( $R_{IN+} = 1 V$ and $R_{IN-} = 1.4 V$ ) or ( $R_{IN+} = 1.4 V$ and $R_{IN-} = 1 V$ )	-	-	7.0	
		Driver Disabled, Receiver Disabled	-	-	7.0	
$C_{IN}$	Input Capacitance	Any LVTTTL or LVDS Input	-	4	-	pF
$C_{OUT}$	Output Capacitance	Any LVTTTL or LVDS Output	-	6	-	pF

1. All typical values are at  $T_A = 25^\circ C$  and with  $V_{CC} = 3.3 V$ .

# FIN1019

## AC ELECTRICAL CHARACTERISTICS (Over supply voltage and operating temperature ranges, unless otherwise specified)

Symbol	Parameter	Test Conditions	Min	Typ (Note 2)	Max	Unit
<b>DRIVER TIMING CHARACTERISTICS</b>						
t <sub>PLHD</sub>	Differential Propagation Delay LOW-to-HIGH	R <sub>L</sub> = 100 Ω, C <sub>L</sub> = 10 pF, See Figure 2 and Figure 3	0.5	–	1.5	ns
t <sub>PHLD</sub>	Differential Propagation Delay HIGH-to-LOW		0.5	–	1.5	ns
t <sub>TLHD</sub>	Differential Output Rise Time (20% to 80%)		0.4	–	1.0	ns
t <sub>THLD</sub>	Differential Output Fall Time (80% to 20%)		0.4	–	1.0	ns
t <sub>SK(P)</sub>	Pulse Skew  t <sub>PLH</sub> – t <sub>PHL</sub>		–	–	0.5	ns
t <sub>SK(PP)</sub>	Part-to-Part Skew (Note 3)	R <sub>L</sub> = 100 Ω, C <sub>L</sub> = 10 pF, See Figure 4 and Figure 5	–	–	1.0	ns
t <sub>ZHD</sub>	Differential Output Enable Time from Z to HIGH		–	–	5.0	ns
t <sub>ZLD</sub>	Differential Output Enable Time from Z to LOW		–	–	5.0	ns
t <sub>HZD</sub>	Differential Output Disable Time from HIGH to Z		–	–	5.0	ns
t <sub>LZD</sub>	Differential Output Disable Time from LOW to Z		–	–	5.0	ns
<b>RECEIVER TIMING CHARACTERISTICS</b>						
t <sub>PLH</sub>	Propagation Delay LOW-to-HIGH	V <sub>ID</sub>   = 400 mV, C <sub>L</sub> = 10 pF, See Figure 6 and Figure 7	0.9	–	2.5	ns
t <sub>PHL</sub>	Propagation Delay HIGH-to-LOW		0.9	–	2.5	ns
t <sub>TLH</sub>	Output Rise Time (20% to 80%)		–	0.5	–	ns
t <sub>THL</sub>	Output Fall Time (80% to 20%)		–	0.5	–	ns
t <sub>SK(P)</sub>	Pulse Skew  t <sub>PLH</sub> – t <sub>PHL</sub>		–	–	0.5	ns
t <sub>SK(PP)</sub>	Part-to-Part Skew (Note 3)	–	–	1.0	ns	
t <sub>ZH</sub>	LVTTTL Output Enable Time from Z to HIGH	R <sub>L</sub> = 500 Ω, C <sub>L</sub> = 10 pF, See Figure 8	–	–	5.0	ns
t <sub>ZL</sub>	LVTTTL Output Enable Time from Z to LOW		–	–	5.0	ns
t <sub>HZ</sub>	LVTTTL Output Disable Time from HIGH to Z		–	–	5.0	ns
t <sub>LZ</sub>	LVTTTL Output Disable Time from LOW to Z		–	–	5.0	ns

2. All typical values are at T<sub>A</sub> = 25°C and with V<sub>CC</sub> = 5 V.

3. t<sub>SK(PP)</sub> is the magnitude of the difference in propagation delay times between any specified terminals of two devices switching in the same direction (either LOW-to-HIGH or HIGH-to-LOW) when both devices operate with the same supply voltage, same temperature, and have identical test circuits.

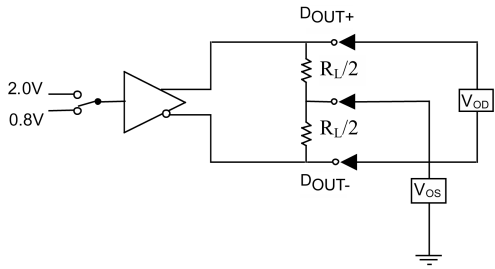
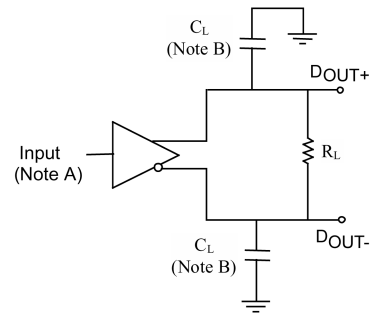

Figure 1. Differential Driver DC Test Circuit



NOTE A: Input pulses have frequency = 10 MHz,  $t_R$  or  $t_F$  = 2 ns  
 NOTE B:  $C_L$  includes all probe and fixture capacitances

Figure 2. Differential Driver Propagation Delay and Transition Time Test Circuit

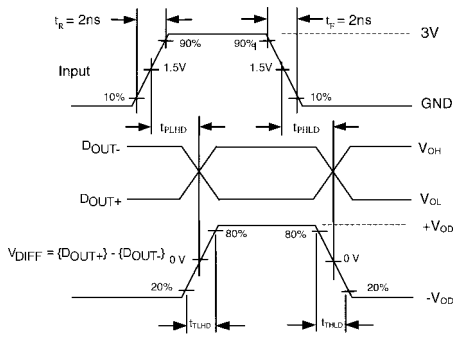
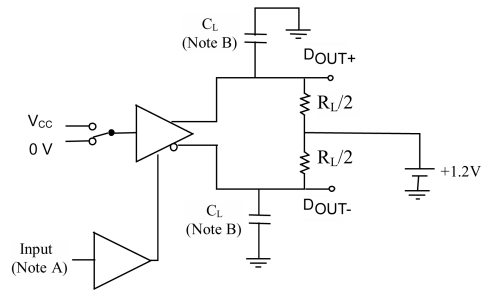

Figure 3. AC Waveforms for Differential Driver



NOTE B: Input pulses have the frequency = 10 MHz,  $t_R$  or  $t_F$  = 2 ns  
 NOTE A:  $C_L$  includes all probe and fixture capacitances

Figure 4. Differential Driver Enable and Disable Test Circuit

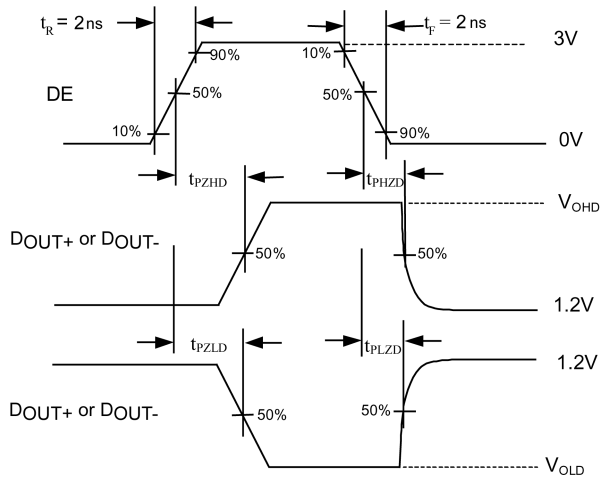
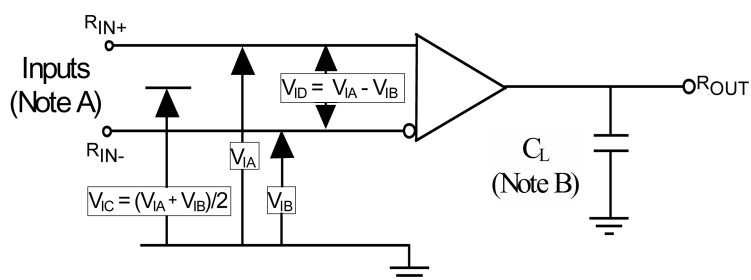

Figure 5. Enable and Disable AC Waveforms

# FIN1019



NOTE A: Input pulses have frequency = 10 MHz, tR or tF = 1 ns

NOTE B: C<sub>L</sub> includes all probe and fixture capacitance

**Figure 6. Differential Receiver Voltage Definitions and Propagation Delay and Transition Time Test Circuit**

**Table 1. RECEIVER MINIMUM AND MAXIMUM INPUT THRESHOLD TEST VOLTAGES**

Applied Voltages (V)		Resulting Differential Input Voltage (mV)	Resulting Common Mode Input Voltage (V)
V <sub>IA</sub>	V <sub>IB</sub>	V <sub>ID</sub>	V <sub>IC</sub>
1.25	1.15	100	1.2
1.15	1.25	-100	1.2
2.4	2.3	100	2.35
2.3	2.4	-100	2.35
0.1	0	100	0.05
0	0.1	-100	0.05
1.5	0.9	600	1.2
0.9	1.5	-600	1.2
2.4	1.8	600	2.1
1.8	2.4	-600	2.1
0.6	0	600	0.3
0	0.6	-600	0.3

# FIN1019

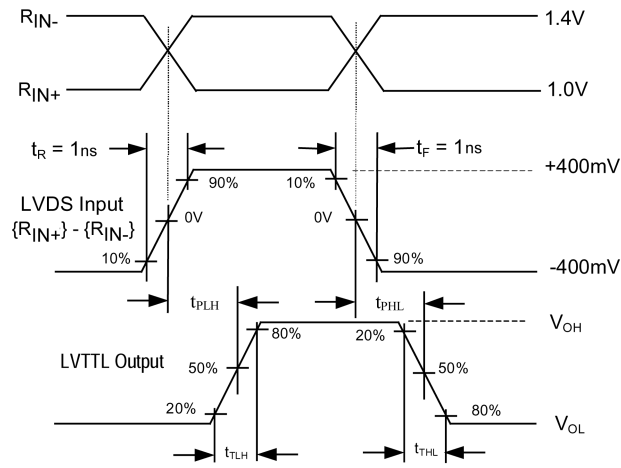
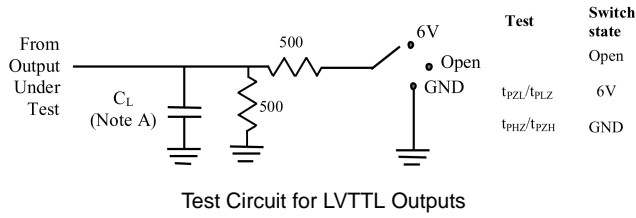

Figure 7. LVDS Input to LVTTTL Output AC Waveforms



Voltage Waveforms Enable and Disable Times

Figure 8. LVTTTL Outputs Test Circuit and AC Waveforms

DC / AC TYPICAL PERFORMANCE CURVES

Drivers

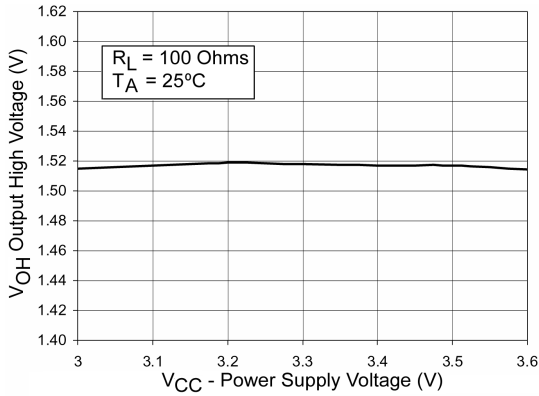

Figure 9. Output High Voltage vs. Power Supply Voltage

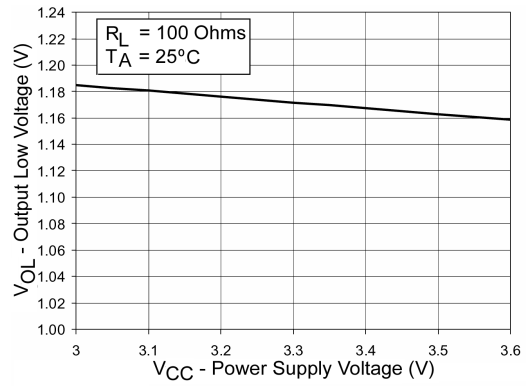

Figure 10. Output Low Voltage vs. Power Supply Voltage

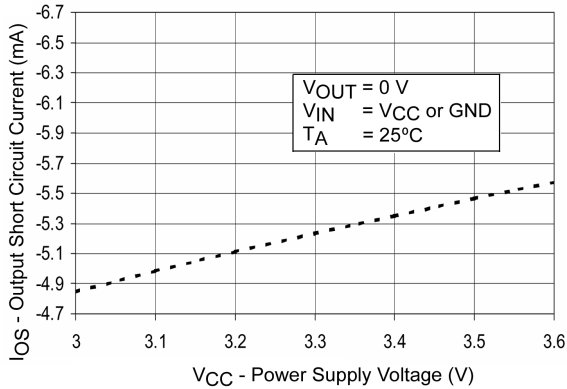

Figure 11. Output Short Circuit Current vs. Power Supply Voltage

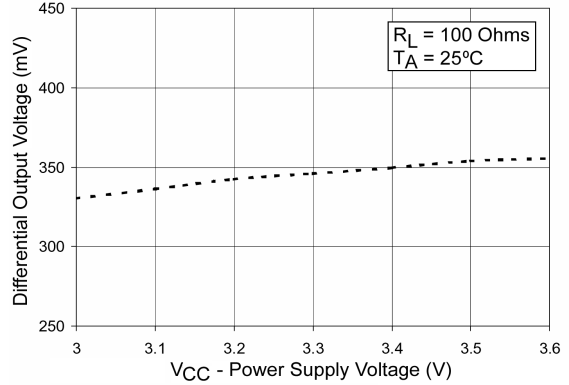

Figure 12. Differential Output Voltage vs. Power Supply Voltage

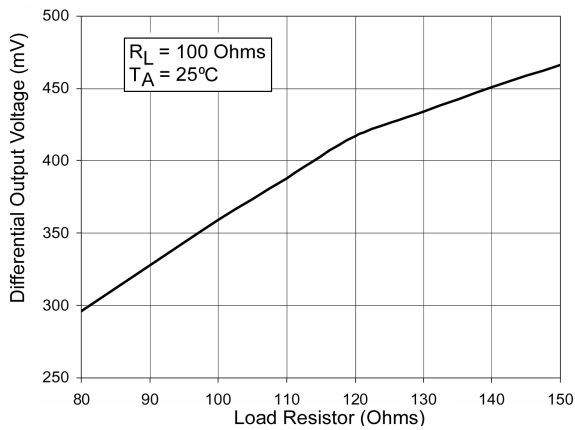

Figure 13. Differential Output Voltage vs. Load Resistor

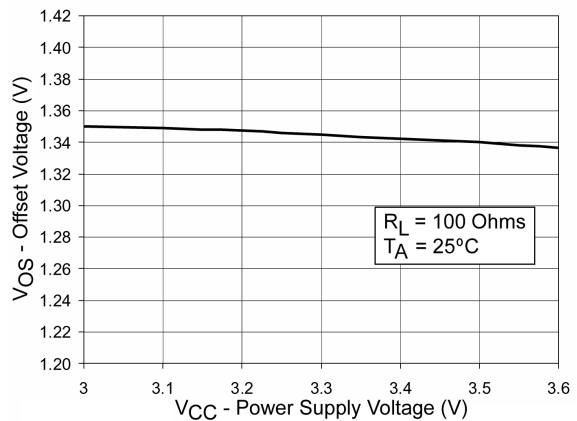

Figure 14. Offset Voltage vs. Power Supply Voltage



DC / AC TYPICAL PERFORMANCE CURVES (continued)

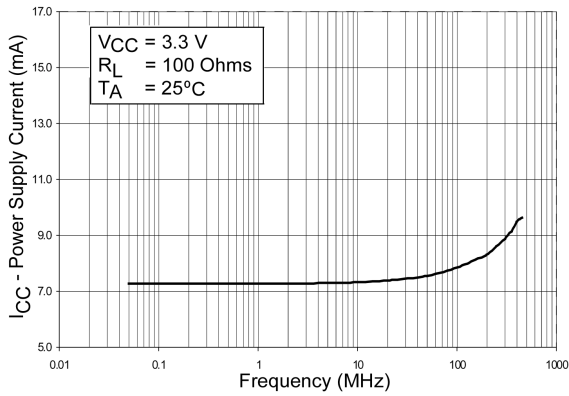

Figure 15. Power Supply Current vs. Frequency

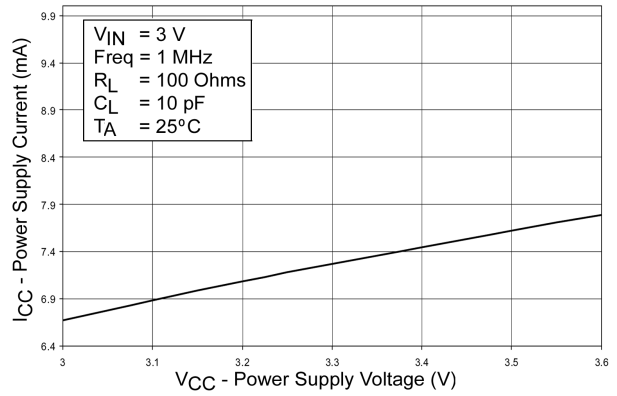

Figure 16. Power Supply Current vs. Power Supply Voltage

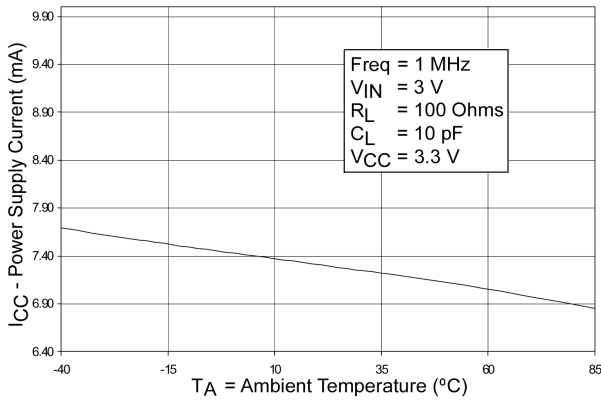

Figure 17. Power Supply Current vs. Ambient Temperature

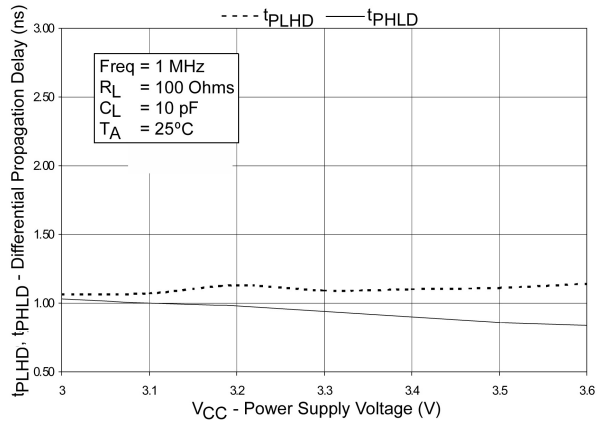

Figure 18. Differential Propagation Delay vs. Power Supply

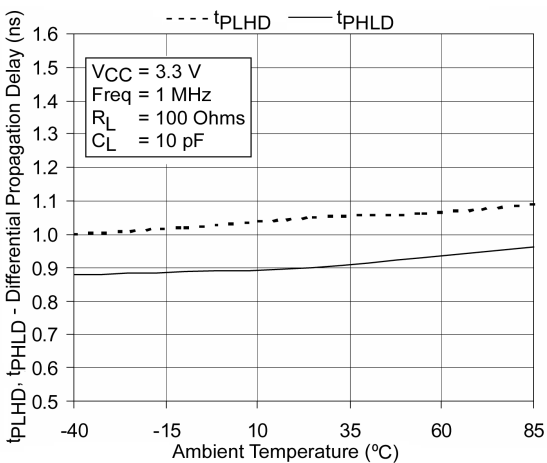

Figure 19. Differential Propagation Delay vs. Ambient Temperature

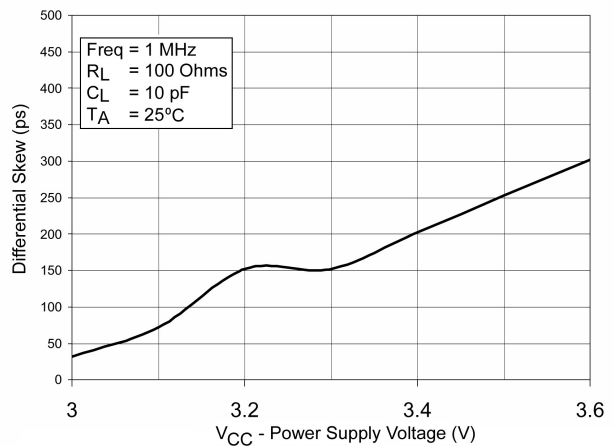

Figure 20. Differential Skew ( $t_{PLH} - t_{PHL}$ ) vs. Power Supply Voltage

DC / AC TYPICAL PERFORMANCE CURVES (continued)

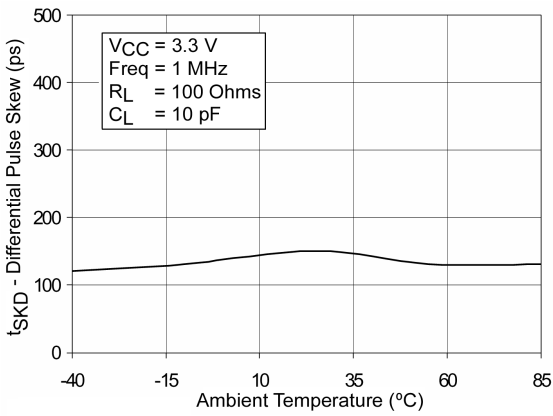

Figure 21. Differential Pulse Skew ( $t_{PLH} - t_{PHL}$ ) vs. Ambient Temperature

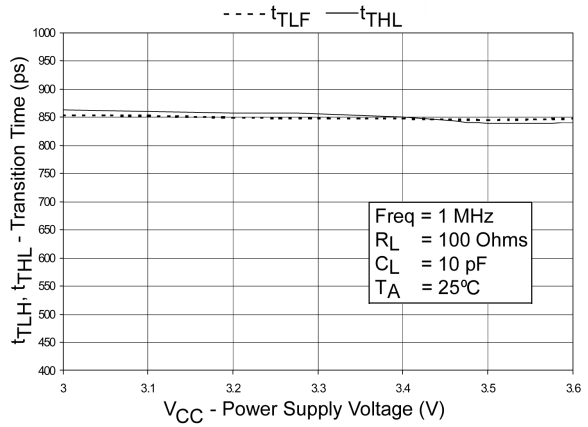

Figure 22. Transition Time vs. Power Supply Voltage

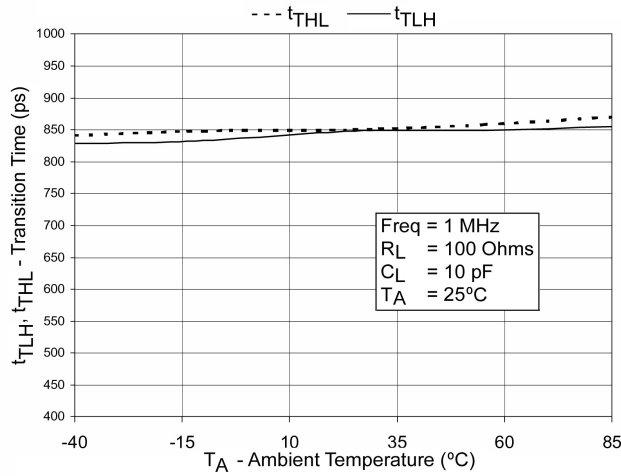

Figure 23. Transition Times vs. Ambient Temperature

DC / AC TYPICAL PERFORMANCE CURVES

Receiver

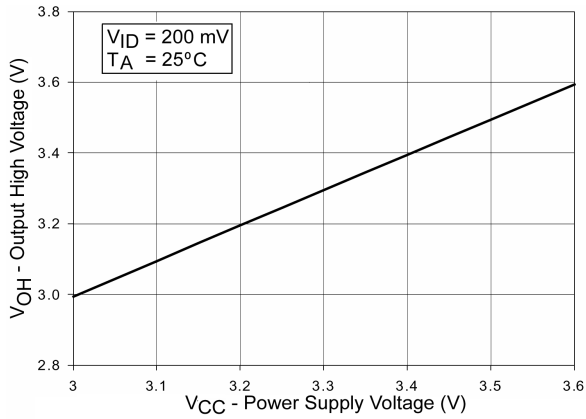

Figure 24. Output High Voltage vs. Power Supply Voltage

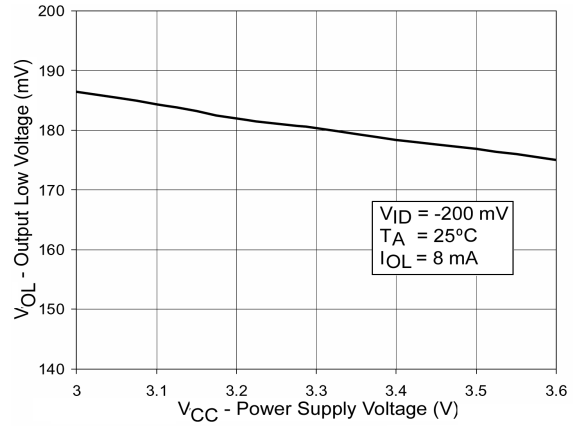

Figure 25. Output Low Voltage vs. Power Supply Voltage

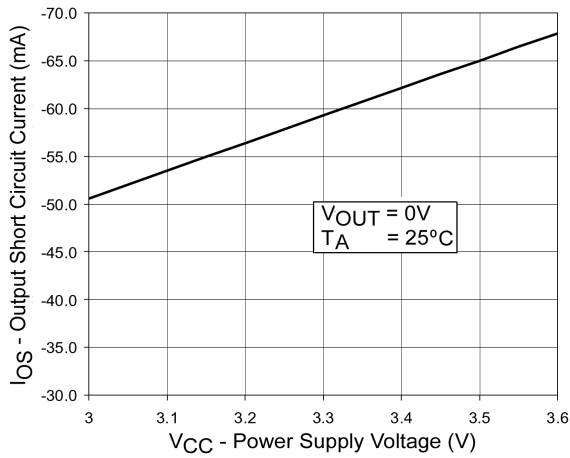

Figure 26. Output Short Circuit Current vs. Power Supply Voltage

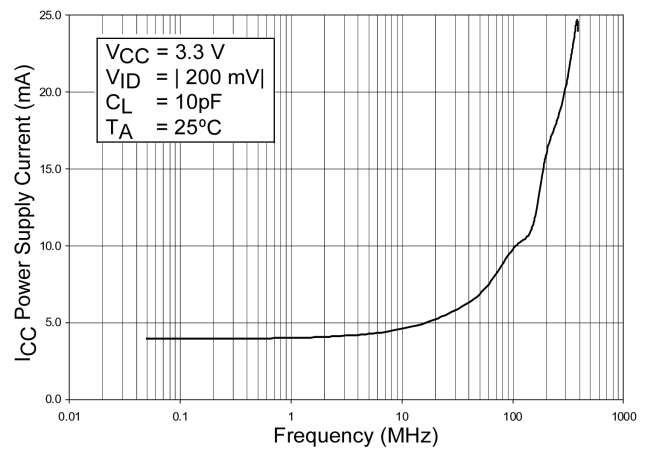

Figure 27. Power Supply Current vs. Frequency

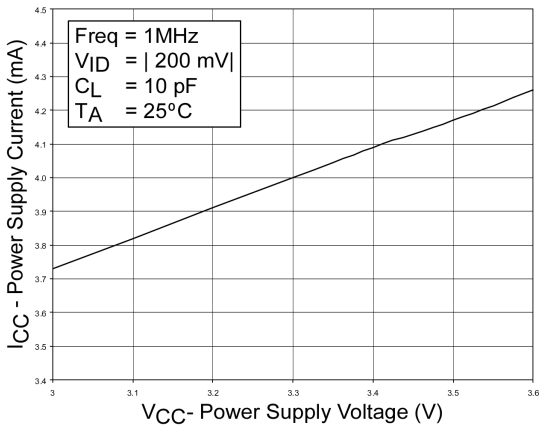

Figure 28. Power Supply Current vs. Power Supply Voltage

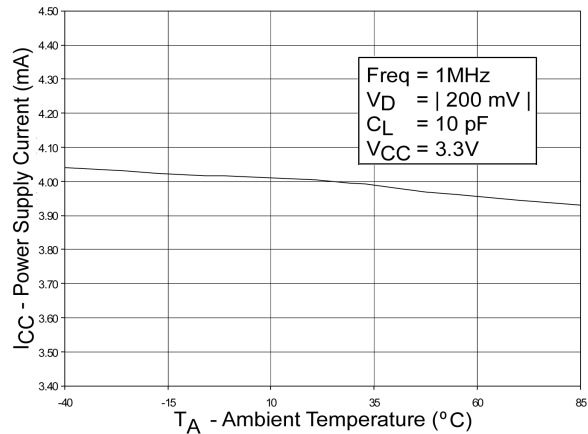

Figure 29. Power Supply Current vs. Ambient Temperature

DC / AC TYPICAL PERFORMANCE CURVES (continued)

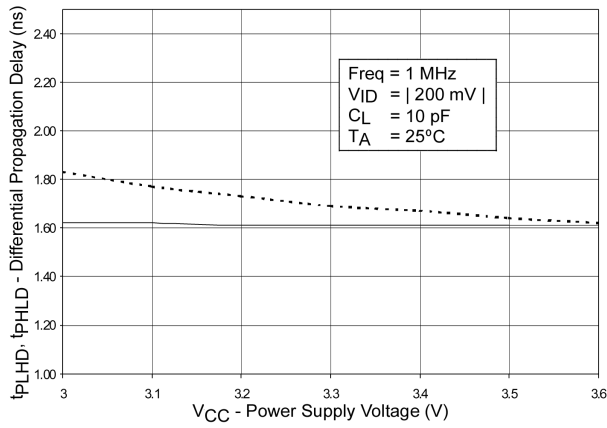

Figure 30. Differential Propagation Delay vs. Power Supply Voltage

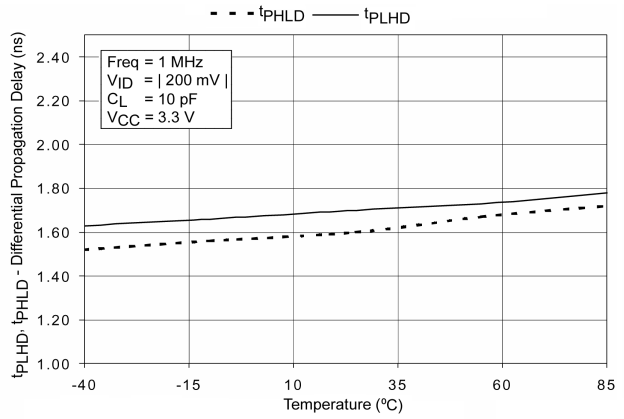

Figure 31. Differential Propagation Delay vs. Ambient Temperature

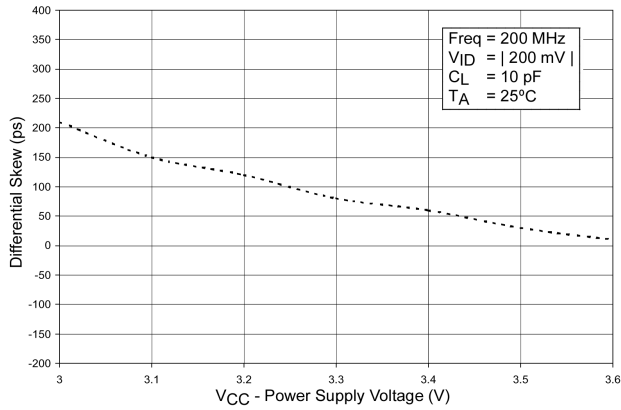

Figure 32. Differential Skew ( $t_{PHL} - t_{PHL}$ ) vs. Power Supply Voltage

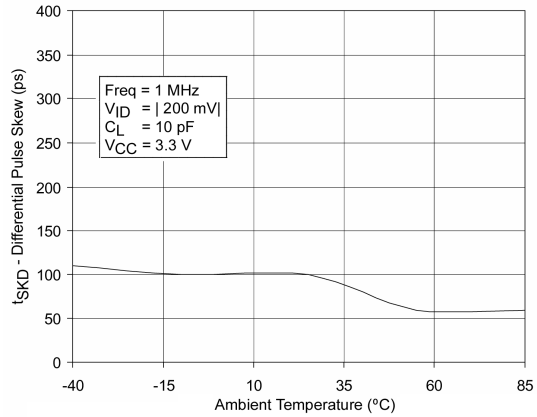

Figure 33. Differential Skew ( $t_{PLH} - t_{PLH}$ ) vs. Ambient Temperature

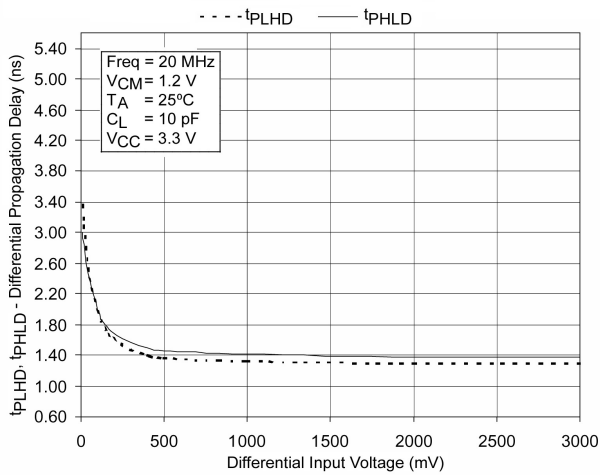

Figure 34. Differential Propagation Delay vs. Differential Input Voltage

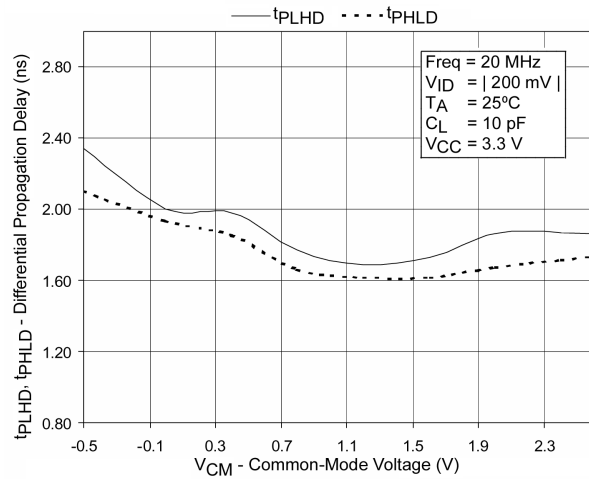

Figure 35. Differential Propagation Delay vs. Common-Mode Voltage

DC / AC TYPICAL PERFORMANCE CURVES (continued)

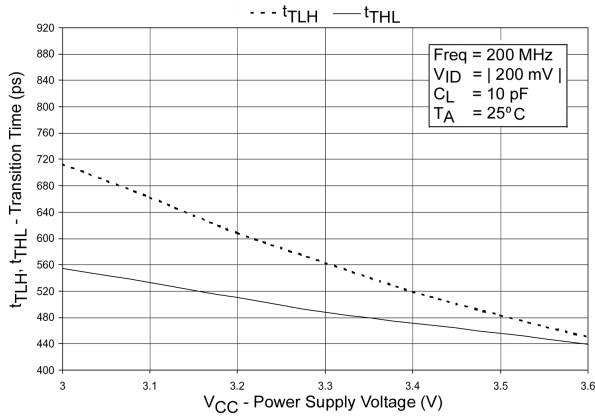

Figure 36. Transition Time vs. Power Supply Voltage

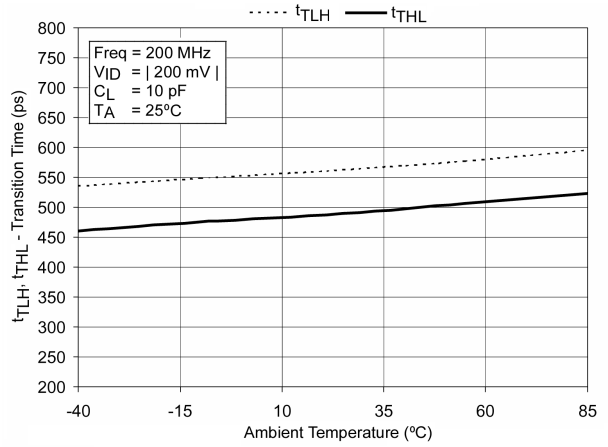

Figure 37. Transition Time vs. Ambient Temperature

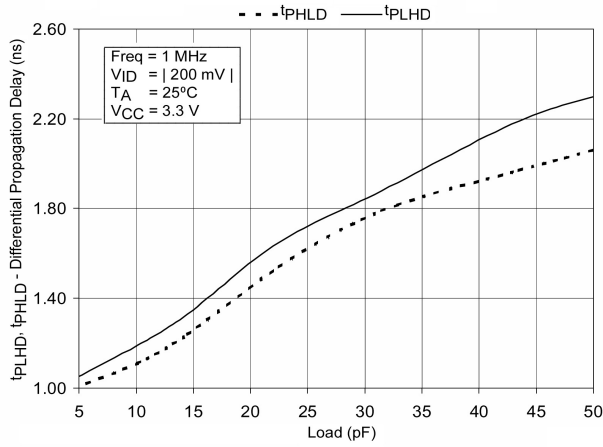

Figure 38. Differential Propagation Delay vs. Load

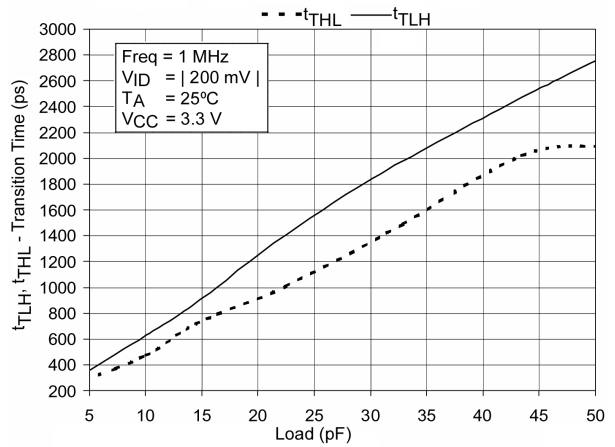
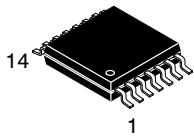

Figure 39. Transition Time vs. Load

# MECHANICAL CASE OUTLINE PACKAGE DIMENSIONS



**TSSOP-14 WB**  
CASE 948G  
ISSUE C

DATE 17 FEB 2016

SCALE 2:1

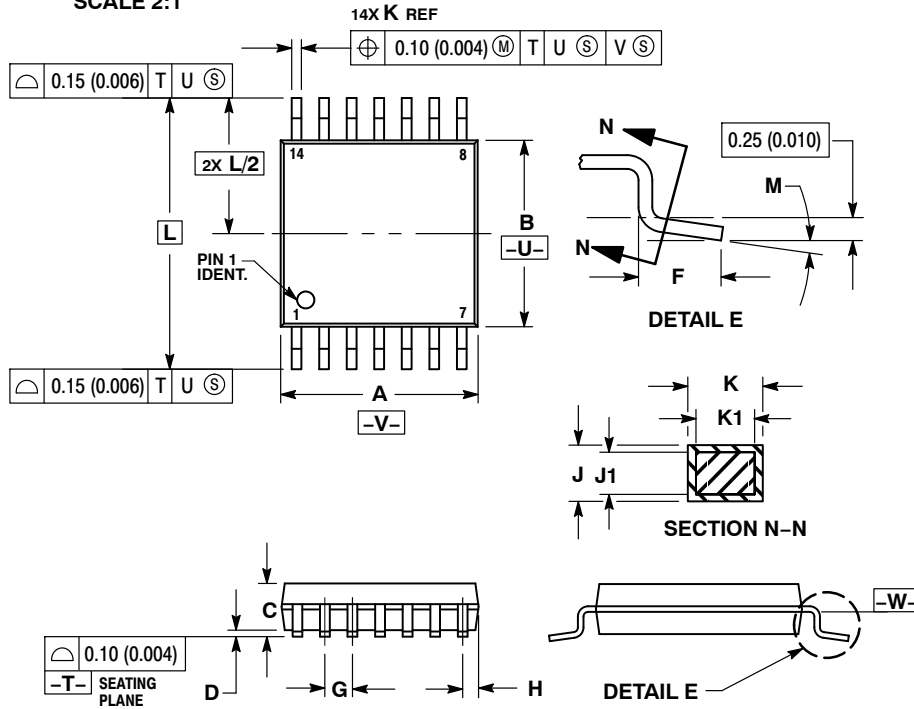

**NOTES:**

- DIMENSIONING AND TOLERANCING PER ANSI Y14.5M, 1982.
- CONTROLLING DIMENSION: MILLIMETER.
- DIMENSION A DOES NOT INCLUDE MOLD FLASH, PROTRUSIONS OR GATE BURRS. MOLD FLASH OR GATE BURRS SHALL NOT EXCEED 0.15 (0.006) PER SIDE.
- DIMENSION B DOES NOT INCLUDE INTERLEAD FLASH OR PROTRUSION. INTERLEAD FLASH OR PROTRUSION SHALL NOT EXCEED 0.25 (0.010) PER SIDE.
- DIMENSION K DOES NOT INCLUDE DAMBAR PROTRUSION. ALLOWABLE DAMBAR PROTRUSION SHALL BE 0.08 (0.003) TOTAL IN EXCESS OF THE K DIMENSION AT MAXIMUM MATERIAL CONDITION.
- TERMINAL NUMBERS ARE SHOWN FOR REFERENCE ONLY.
- DIMENSION A AND B ARE TO BE DETERMINED AT DATUM PLANE -W-.

DIM	MILLIMETERS		INCHES	
	MIN	MAX	MIN	MAX
A	4.90	5.10	0.193	0.200
B	4.30	4.50	0.169	0.177
C	---	1.20	---	0.047
D	0.05	0.15	0.002	0.006
F	0.50	0.75	0.020	0.030
G	0.65 BSC		0.026 BSC	
H	0.50	0.60	0.020	0.024
J	0.09	0.20	0.004	0.008
J1	0.09	0.16	0.004	0.006
K	0.19	0.30	0.007	0.012
K1	0.19	0.25	0.007	0.010
L	6.40 BSC		0.252 BSC	
M	0°	8°	0°	8°

**GENERIC MARKING DIAGRAM\***

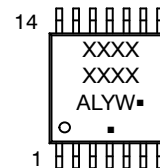

- A = Assembly Location
- L = Wafer Lot
- Y = Year
- W = Work Week
- = Pb-Free Package

(Note: Microdot may be in either location)

\*This information is generic. Please refer to device data sheet for actual part marking. Pb-Free indicator, "G" or microdot "▪", may or may not be present. Some products may not follow the Generic Marking.

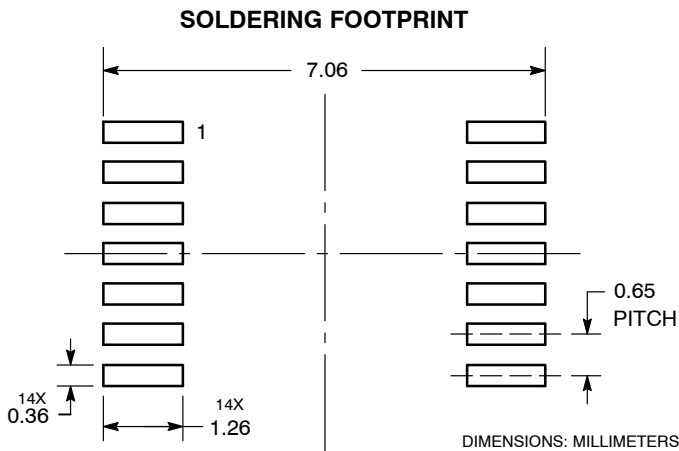

<b>DOCUMENT NUMBER:</b>	<b>98ASH70246A</b>	Electronic versions are uncontrolled except when accessed directly from the Document Repository. Printed versions are uncontrolled except when stamped "CONTROLLED COPY" in red.
<b>DESCRIPTION:</b>	<b>TSSOP-14 WB</b>	<b>PAGE 1 OF 1</b>

onsemi and onsemi are trademarks of Semiconductor Components Industries, LLC dba onsemi or its subsidiaries in the United States and/or other countries. onsemi reserves the right to make changes without further notice to any products herein. onsemi makes no warranty, representation or guarantee regarding the suitability of its products for any particular purpose, nor does onsemi assume any liability arising out of the application or use of any product or circuit, and specifically disclaims any and all liability, including without limitation special, consequential or incidental damages. onsemi does not convey any license under its patent rights nor the rights of others.

**onsemi**, **Onsemi**, and other names, marks, and brands are registered and/or common law trademarks of Semiconductor Components Industries, LLC dba "**onsemi**" or its affiliates and/or subsidiaries in the United States and/or other countries. **onsemi** owns the rights to a number of patents, trademarks, copyrights, trade secrets, and other intellectual property. A listing of **onsemi**'s product/patent coverage may be accessed at [www.onsemi.com/site/pdf/Patent-Marking.pdf](http://www.onsemi.com/site/pdf/Patent-Marking.pdf). **onsemi** reserves the right to make changes at any time to any products or information herein, without notice. The information herein is provided "as-is" and **onsemi** makes no warranty, representation or guarantee regarding the accuracy of the information, product features, availability, functionality, or suitability of its products for any particular purpose, nor does **onsemi** assume any liability arising out of the application or use of any product or circuit, and specifically disclaims any and all liability, including without limitation special, consequential or incidental damages. Buyer is responsible for its products and applications using **onsemi** products, including compliance with all laws, regulations and safety requirements or standards, regardless of any support or applications information provided by **onsemi**. "Typical" parameters which may be provided in **onsemi** data sheets and/or specifications can and do vary in different applications and actual performance may vary over time. All operating parameters, including "Typicals" must be validated for each customer application by customer's technical experts. **onsemi** does not convey any license under any of its intellectual property rights nor the rights of others. **onsemi** products are not designed, intended, or authorized for use as a critical component in life support systems or any FDA Class 3 medical devices or medical devices with a same or similar classification in a foreign jurisdiction or any devices intended for implantation in the human body. Should Buyer purchase or use **onsemi** products for any such unintended or unauthorized application, Buyer shall indemnify and hold **onsemi** and its officers, employees, subsidiaries, affiliates, and distributors harmless against all claims, costs, damages, and expenses, and reasonable attorney fees arising out of, directly or indirectly, any claim of personal injury or death associated with such unintended or unauthorized use, even if such claim alleges that **onsemi** was negligent regarding the design or manufacture of the part. **onsemi** is an Equal Opportunity/Affirmative Action Employer. This literature is subject to all applicable copyright laws and is not for resale in any manner.

## ADDITIONAL INFORMATION

### TECHNICAL PUBLICATIONS:

Technical Library: [www.onsemi.com/design/resources/technical-documentation](http://www.onsemi.com/design/resources/technical-documentation)  
onsemi Website: [www.onsemi.com](http://www.onsemi.com)

### ONLINE SUPPORT: [www.onsemi.com/support](http://www.onsemi.com/support)

For additional information, please contact your local Sales Representative at [www.onsemi.com/support/sales](http://www.onsemi.com/support/sales)