





CURRENT SENSE INDUCTORS

FIS Series



-  Current sense inductors, as feedback elements linking the output and pulse control circuitry, allow low-cost regulation of switch-mode power supplies
-  Fully encapsulated with a frequency of 200 kHz maximum
-  Isolation Pri to Sec: 2500 V_{AC}
-  Pri. current: 15 A maximum

Electrical Specifications @ 25°C

Part No.	Prim/Sec Ratio	Sec L (mH MIN)	Sec DCR (Ω MAX)	V x τ (MAX)
FIS 101	1/50	5.0	0.65	175 VμS
FIS 111	1/100	22.0	1.30	350 VμS
FIS 121	1/200	94.5	4.50	700 VμS

Notes:

L: Inductance: (1-3) tested at 10 KHz & 10 mV

V x τ: V = R_t x I_s

$$\tau = \frac{1}{2F}$$

R_t (Ω): Recommended Terminating Resistance

I_s (A): sec. current

F(Hz): Frequency

Mechanical

Schematic

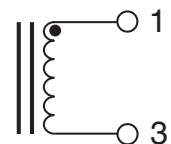
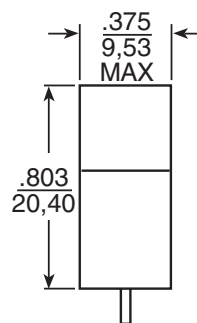
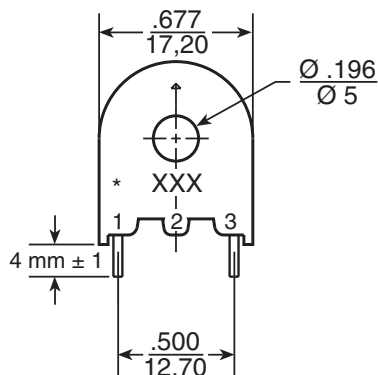

For More Information :

UNITED STATES (Worldwide)

12220 World Trade Drive
San Diego, CA 92128
U.S.A.
http://www.pulseeng.com
TEL: 858 674 8100
FAX: 858 674 8262

UNITED KINGDOM (Northern Europe)

1 & 2 Huxley Road
The Surrey Research Park
Guildford, Surrey GU2 5RE
United Kingdom
TEL: 44 1483 401700
FAX: 44 1483 401701

FRANCE (Southern Europe)

Zone Industrielle
F-39270
Orgelet
France
TEL: 33 3 84 35 04 04
FAX: 33 3 84 25 46 41

SINGAPORE (Southern Asia)

150 Kampong Ampat
#07-01/02
KA Centre
Singapore 368324
TEL: 65 6287 8998
FAX: 65 6280 0080

TAIWAN, R.O.C. (Northern Asia)

3F-4, No. 81, Sec. 1
HsinTai Wu Road
Hsi-Chih, Taipei Hsien
Taiwan, R.O.C.
Tel: 886 2 2698 0228
FAX: 886 2 2698 0948

HONG KONG (China/Hong Kong)

9/F, Phase 2, Tai Sang
Shatin Warehouse Centre
6 Wong Chuk Yeung Street
Fotan, Shatin, Hong Kong
Tel: 852 2788 6588
FAX: 852 2776 1055

DISTRIBUTOR

Performance warranty of products offered on this data sheet is limited to the parameters specified. Data is subject to change without notice. Other brand and product names mentioned herein may be trademarks or registered trademarks of their respective owners.