

FJZ945

Audio Frequency Amplifier & High Frequency OSC.

- Complement to FJZ733
- Collector-Base Voltage : $V_{CBO}=60V$
- High Current Gain Bandwidth Product : $f_T=300MHz$ (Typ.)

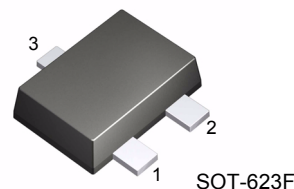

1. Base 2. Emitter 3. Collector

NPN Epitaxial Silicon Transistor

Absolute Maximum Ratings $T_a=25^\circ C$ unless otherwise noted

Symbol	Parameter	Value	Units
V_{CBO}	Collector-Base Voltage	60	V
V_{CEO}	Collector-Emitter Voltage	50	V
V_{EBO}	Emitter-Base Voltage	5	V
I_C	Collector Current	150	mA
P_C	Collector Power Dissipation	100	mW
T_J	Junction Temperature	150	$^\circ C$
T_{STG}	Storage Temperature	-55 ~ 150	$^\circ C$

Electrical Characteristics $T_a=25^\circ C$ unless otherwise noted

Symbol	Parameter	Test Condition	Min.	Typ.	Max.	Units
BV_{CBO}	Collector-Base Breakdown Voltage	$I_C=100\mu A, I_E=0$	60			V
BV_{CEO}	Collector-Emitter Breakdown Voltage	$I_C=10mA, I_B=0$	50			V
BV_{EBO}	Emitter-Base Breakdown Voltage	$I_E=10\mu A, I_C=0$	5			V
I_{CBO}	Collector Cut-off Current	$V_{CB}=40V, I_E=0$			0.1	μA
I_{EBO}	Emitter Cut-off Current	$V_{EB}=3V, I_C=0$			0.1	μA
h_{FE}	DC Current Gain	$V_{CE}=6V, I_C=1.0mA$	40		700	
$V_{CE(sat)}$	Collector-Emitter Saturation Voltage	$I_C=100mA, I_B=10mA$		0.15	0.3	V
f_T	Current Gain Bandwidth Product	$V_{CE}=6V, I_C=10mA$		300		MHz
C_{ob}	Output Capacitance	$V_{CB}=6V, I_E=0, f=1MHz$		2.5		pF
NF	Noise Figure	$V_{CE}=6V, I_C=0.5mA, f=1KHz, R_S=500\Omega$		4.0		dB

Thermal Characteristics $T_C=25^\circ C$ unless otherwise noted

Symbol	Parameter	Max.	Units
$R_{\theta JA}$	Thermal Resistance, Junction to Ambient	1250	$^\circ C/W$

h_{FE} Classification & Marking

Classification	R	O	Y	G	L
h_{FE}	40 ~ 80	70 ~ 140	120 ~ 240	200 ~ 400	350 ~ 700
Marking	C2	C3	C1	C4	C5

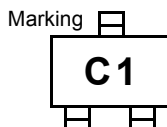

Typical Characteristics

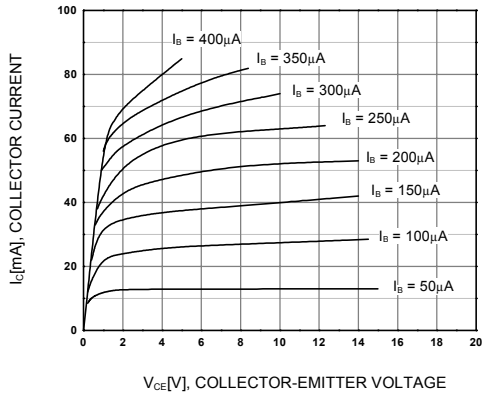

Figure 1. Static Characteristic

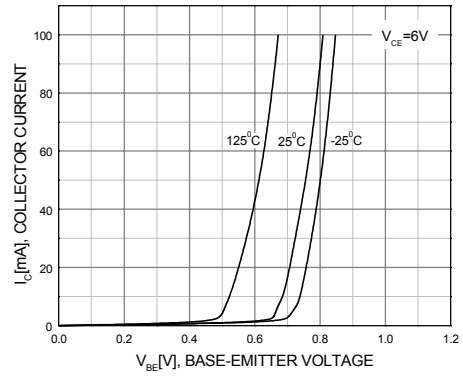

Figure 2. Transfer Characteristic

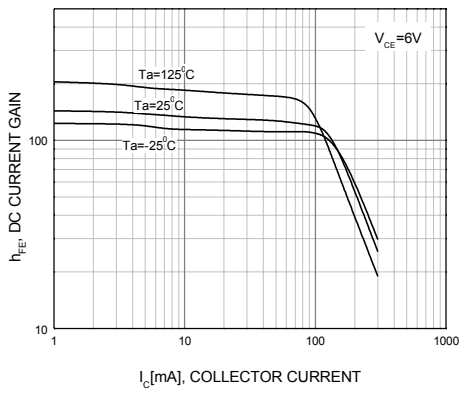

Figure 3. DC Current Gain

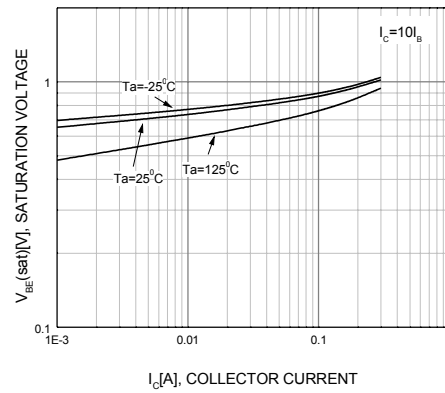

Figure 4. Base-Emitter Saturation Voltage

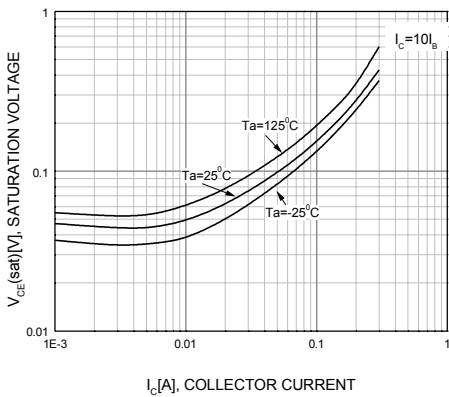

Figure 5. Collector-Emitter Saturation Voltage

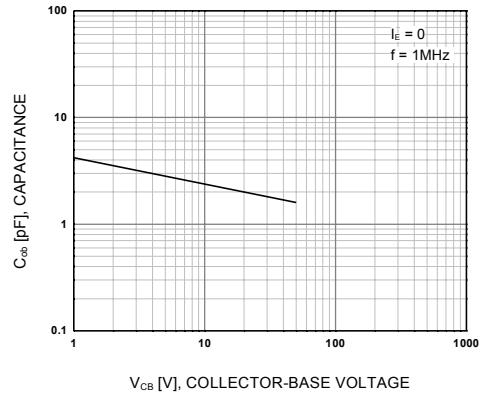

Figure 6. Output Capacitance

Typical Characteristics (Continued)

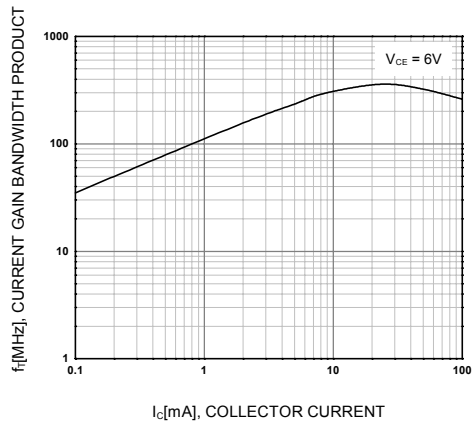
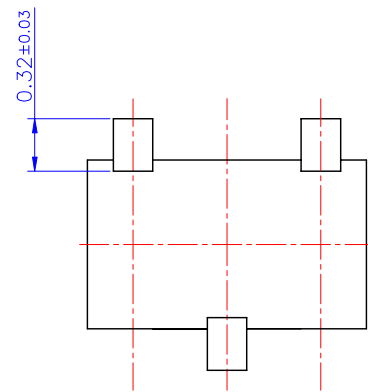
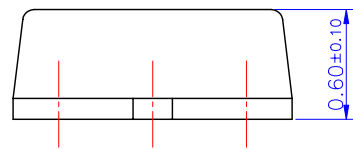
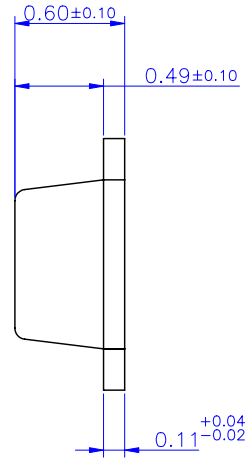
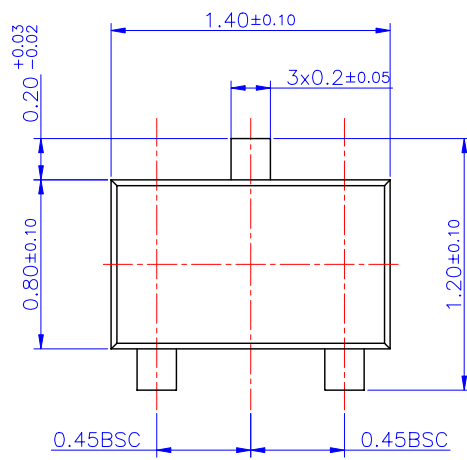

Figure 7. Current Gain Bandwidth Product

Package Dimensions

SOT-623F



Dimensions in Millimeters

TRADEMARKS

The following are registered and unregistered trademarks Fairchild Semiconductor owns or is authorized to use and is not intended to be an exhaustive list of all such trademarks.

ACE ^x TM	FACT TM	ImpliedDisconnect TM	PACMAN TM	SPM TM
ActiveArray TM	FACT Quiet Series TM	ISOPLANAR TM	POP TM	Stealth TM
Bottomless TM	FAST [®]	LittleFET TM	Power247 TM	SuperSOT TM -3
CoolFET TM	FAST ^r TM	MicroFET TM	PowerTrench [®]	SuperSOT TM -6
CROSSVOLT TM	FRFET TM	MicroPak TM	QFET [®]	SuperSOT TM -8
DOME TM	GlobalOptoisolator TM	MICROWIRE TM	QS TM	SyncFET TM
EcoSPARK TM	GTO TM	MSX TM	QT Optoelectronics TM	TinyLogic [®]
E ² CMOS TM	HiSeC TM	MSXPro TM	Quiet Series TM	TruTranslation TM
EnSigna TM	I ² C TM	OCX TM	RapidConfigure TM	UHC TM
Across the board. Around the world. TM		OCXPro TM	RapidConnect TM	UltraFET [®]
The Power Franchise TM		OPTOLOGIC [®]	SILENT SWITCHER [®]	VCX TM
Programmable Active Droop TM		OPTOPLANAR TM	SMART START TM	

DISCLAIMER

FAIRCHILD SEMICONDUCTOR RESERVES THE RIGHT TO MAKE CHANGES WITHOUT FURTHER NOTICE TO ANY PRODUCTS HEREIN TO IMPROVE RELIABILITY, FUNCTION OR DESIGN. FAIRCHILD DOES NOT ASSUME ANY LIABILITY ARISING OUT OF THE APPLICATION OR USE OF ANY PRODUCT OR CIRCUIT DESCRIBED HEREIN; NEITHER DOES IT CONVEY ANY LICENSE UNDER ITS PATENT RIGHTS, NOR THE RIGHTS OF OTHERS.

LIFE SUPPORT POLICY

FAIRCHILD'S PRODUCTS ARE NOT AUTHORIZED FOR USE AS CRITICAL COMPONENTS IN LIFE SUPPORT DEVICES OR SYSTEMS WITHOUT THE EXPRESS WRITTEN APPROVAL OF FAIRCHILD SEMICONDUCTOR CORPORATION.

As used herein:

1. Life support devices or systems are devices or systems which, (a) are intended for surgical implant into the body, or (b) support or sustain life, or (c) whose failure to perform when properly used in accordance with instructions for use provided in the labeling, can be reasonably expected to result in significant injury to the user.
2. A critical component is any component of a life support device or system whose failure to perform can be reasonably expected to cause the failure of the life support device or system, or to affect its safety or effectiveness.

PRODUCT STATUS DEFINITIONS

Definition of Terms

Datasheet Identification	Product Status	Definition
Advance Information	Formative or In Design	This datasheet contains the design specifications for product development. Specifications may change in any manner without notice.
Preliminary	First Production	This datasheet contains preliminary data, and supplementary data will be published at a later date. Fairchild Semiconductor reserves the right to make changes at any time without notice in order to improve design.
No Identification Needed	Full Production	This datasheet contains final specifications. Fairchild Semiconductor reserves the right to make changes at any time without notice in order to improve design.
Obsolete	Not In Production	This datasheet contains specifications on a product that has been discontinued by Fairchild semiconductor. The datasheet is printed for reference information only.