



- ★ Green Device Available
- ★ Super Low Gate Charge
- ★ ESD Protection
- ★ Excellent Cdv/dt effect decline
- ★ Advanced high cell density Trench

Product Summary

BVDSS	RDSON	ID
20V	20mΩ	6A

Description

The FKQ2720 is the low RDSON trenched N-CH MOSFETs with robust ESD protection. This product is suitable for Lithium-ion battery pack applications.

The FKQ2720 meet the RoHS and Green Product requirement with full function reliability approved.

TSOP6 Pin Configuration

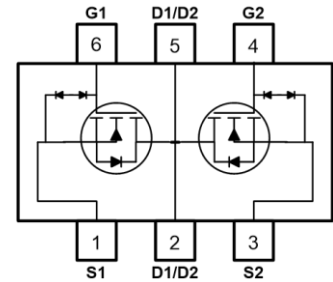
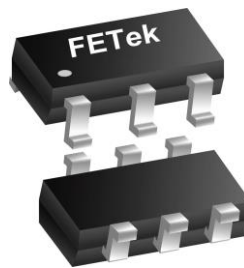

Absolute Maximum Ratings

Symbol	Parameter	Rating	Units
V _{DS}	Drain-Source Voltage	20	V
V _{GS}	Gate-Source Voltage	±12	V
I _D @T _A =25°C	Continuous Drain Current ¹	6	A
I _D @T _A =70°C	Continuous Drain Current ¹	4.8	A
I _{DM}	Pulsed Drain Current ²	25	A
P _D @T _A =25°C	Total Power Dissipation ³	1.25	W
T _{STG}	Storage Temperature Range	-55 to 150	°C
T _J	Operating Junction Temperature Range	-55 to 150	°C

Thermal Data

Symbol	Parameter	Typ.	Max.	Unit
R _{θJA}	Thermal Resistance Junction-ambient ¹	---	100	°C/W

**N-Channel Electrical Characteristics ($T_J=25\text{ }^\circ\text{C}$, unless otherwise noted)**

Symbol	Parameter	Conditions	Min.	Typ.	Max.	Unit
BV_{DSS}	Drain-Source Breakdown Voltage	$V_{GS}=0V, I_D=250\mu A$	20	---	---	V
$R_{DS(ON)}$	Static Drain-Source On-Resistance ²	$V_{GS}=4.5V, I_D=3A$	15	16.5	20	m Ω
		$V_{GS}=4.0V, I_D=3A$	15.5	17	20.5	
		$V_{GS}=3.7V, I_D=3A$	16	17.5	21	
		$V_{GS}=3.1V, I_D=3A$	17	18.5	23	
		$V_{GS}=2.5V, I_D=3A$	18.5	21	26	
$V_{GS(th)}$	Gate Threshold Voltage	$V_{GS}=V_{DS}, I_D=250\mu A$	0.5	0.7	1.2	V
I_{DSS}	Drain-Source Leakage Current	$V_{DS}=16V, V_{GS}=0V, T_J=25^\circ\text{C}$	---	---	1	μA
		$V_{DS}=16V, V_{GS}=0V, T_J=55^\circ\text{C}$	---	---	5	
I_{GSS}	Gate-Source Leakage Current	$V_{GS}=\pm 8V, V_{DS}=0V$	---	---	± 10	μA
g_{fs}	Forward Transconductance	$V_{DS}=5V, I_D=3A$	---	17	---	S
Q_g	Total Gate Charge	$V_{DS}=15V, V_{GS}=4.5V, I_D=6A$	---	10.4	---	nC
Q_{gs}	Gate-Source Charge		---	1.3	---	
Q_{gd}	Gate-Drain Charge		---	2.6	---	
$T_{d(on)}$	Turn-On Delay Time	$V_{DD}=10V, V_{GS}=4.5V, R_G=3.3\Omega$ $I_D=3A$	---	3.2	---	ns
T_r	Rise Time		---	9.8	---	
$T_{d(off)}$	Turn-Off Delay Time		---	31	---	
T_f	Fall Time		---	3.6	---	
C_{iss}	Input Capacitance	$V_{DS}=15V, V_{GS}=0V, f=1\text{MHz}$	---	630	---	pF
C_{oss}	Output Capacitance		---	66	---	
C_{rss}	Reverse Transfer Capacitance		---	63	---	

Diode Characteristics

Symbol	Parameter	Conditions	Min.	Typ.	Max.	Unit
I_S	Continuous Source Current ^{1,4}	$V_G=V_D=0V$, Force Current	---	---	5.5	A
V_{SD}	Diode Forward Voltage ²	$V_{GS}=0V, I_S=1A, T_J=25^\circ\text{C}$	---	0.78	1.2	V

Note :

1. The data tested by surface mounted on a 1 inch² FR-4 board with 2OZ copper, $t \leq 10s$.
2. The data tested by pulsed, pulse width $\leq 300\mu s$, duty cycle $\leq 2\%$
3. The power dissipation is limited by 150°C junction temperature
4. The data is theoretically the same as I_D and I_{DM} , in real applications, should be limited by total power dissipation.

N-Channel Typical Characteristics

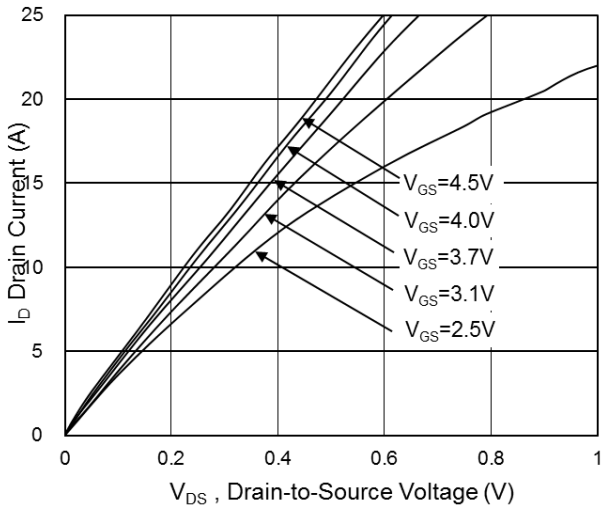

Fig.1 Typical Output Characteristics

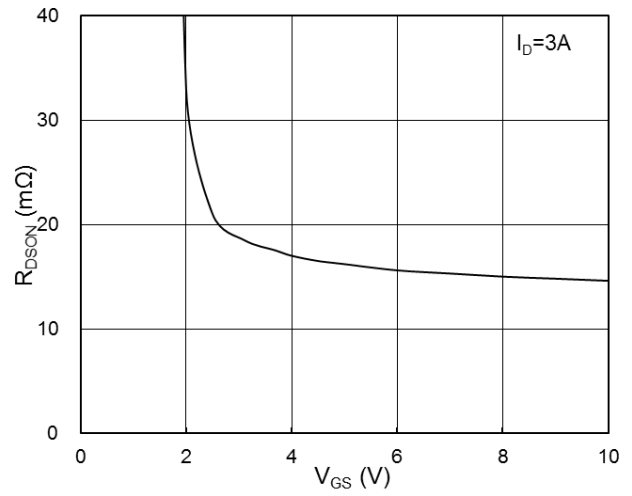

Fig.2 On-Resistance vs. Gate-Source voltage

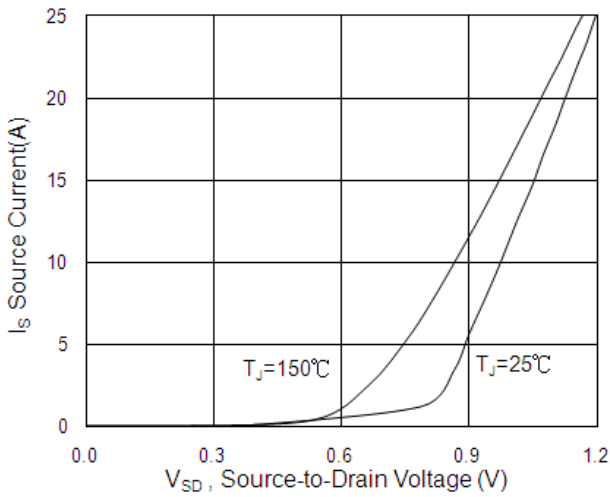

Fig.3 Forward Characteristics of Reverse

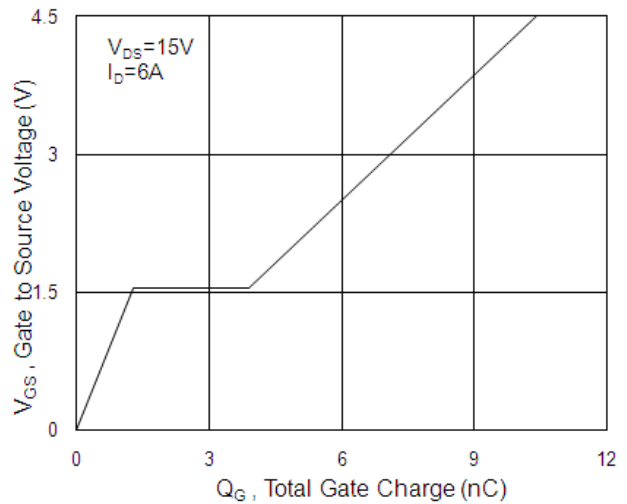

Fig.4 Gate-Charge Characteristics

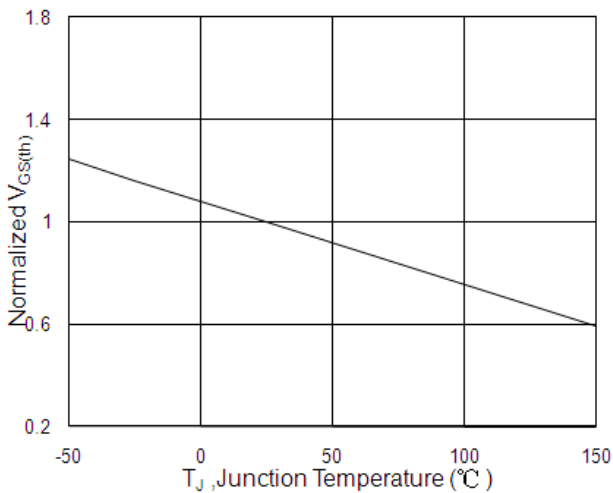

Fig.5 Normalized $V_{GS(th)}$ vs. T_J

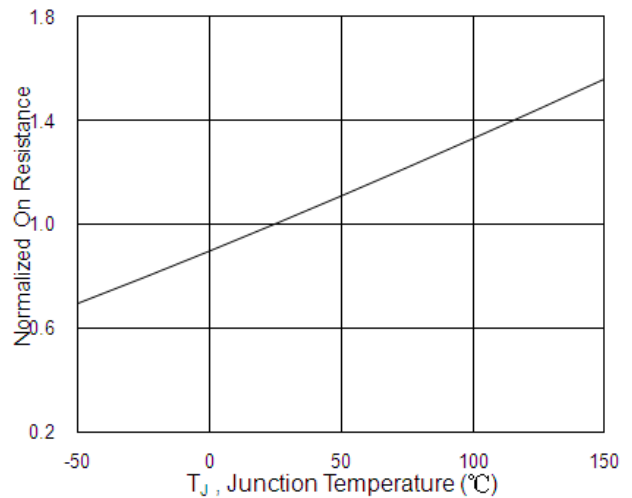

Fig.6 Normalized $R_{DS(on)}$ vs. T_J

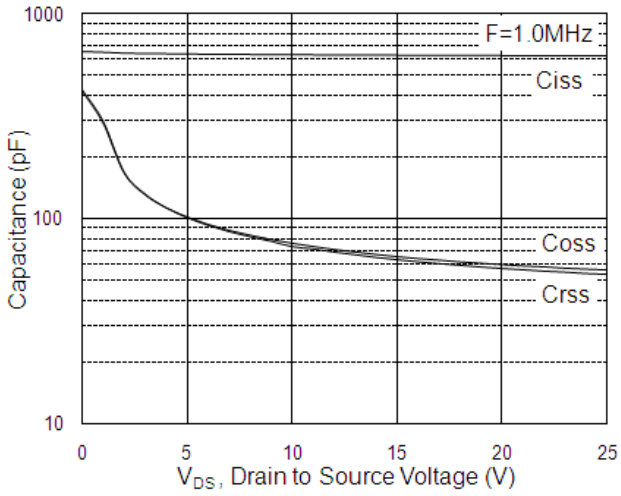

Fig.7 Capacitance

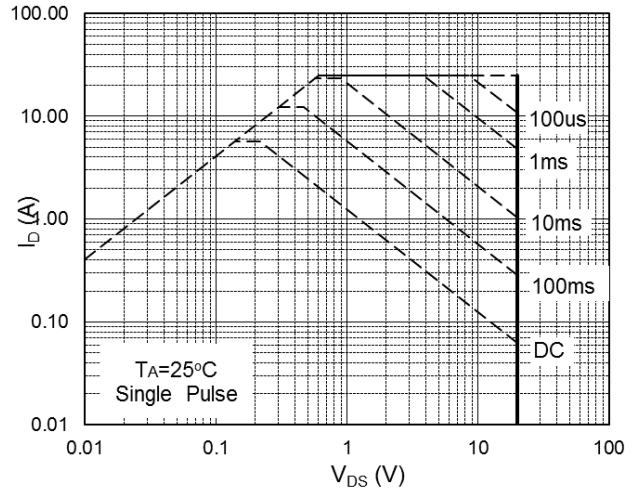

Fig.8 Safe Operating Area

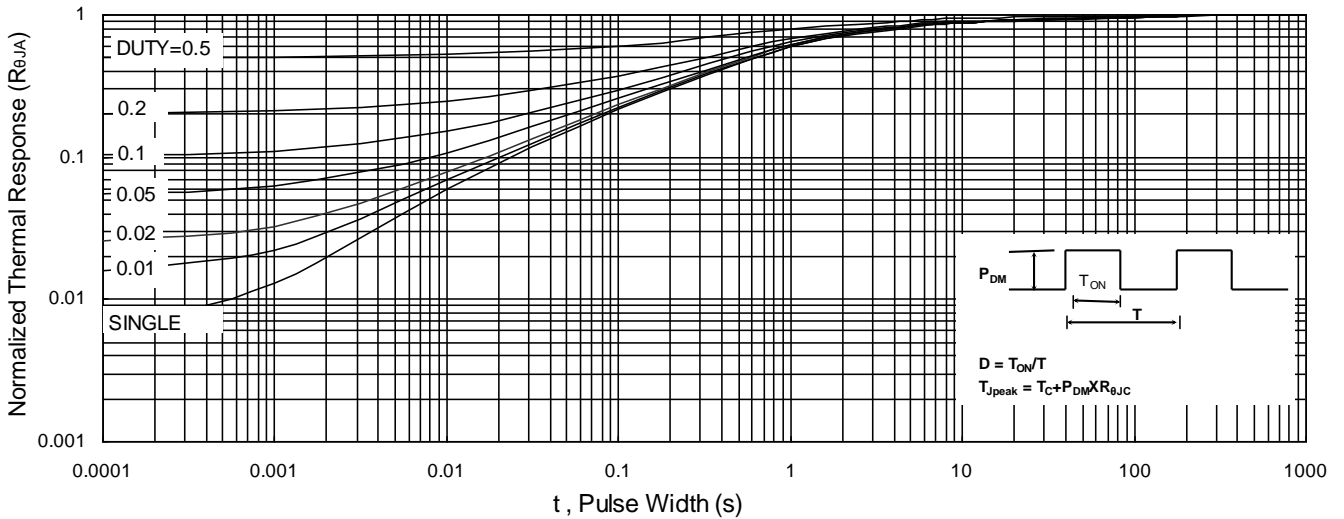

Fig.9 Normalized Maximum Transient Thermal Impedance

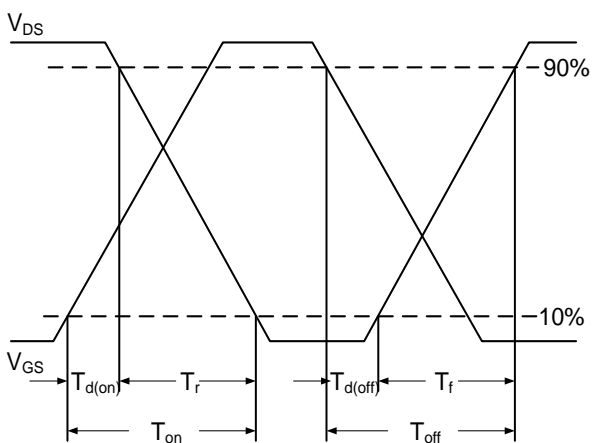

Fig.10 Switching Time Waveform

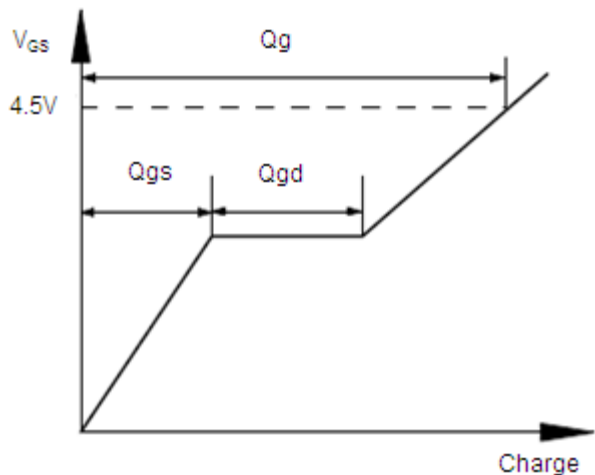
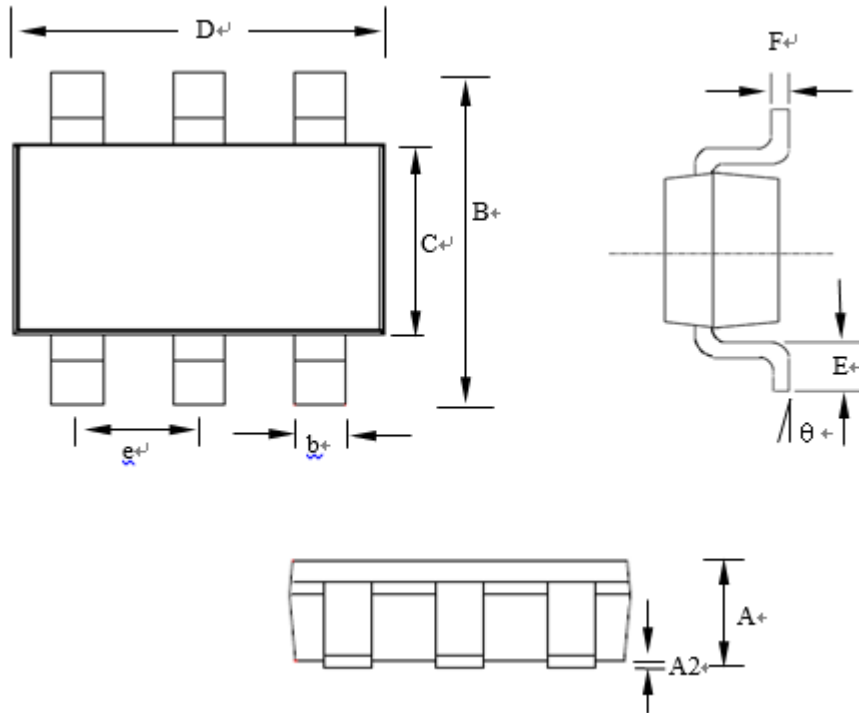

Fig.11 Gate Charge Waveform

TSOP6 Package Outline Dimensions



SYMBOLS	MILLIMETERS			INCHES		
	MIN	NOM	MAX	MIN	NOM	MAX
A	0.70	--	0.9	0.028	--	0.035
A2	0.00	--	0.10	0.000	--	0.004
B	2.60	2.80	3.00	0.102	0.110	0.118
C	1.40	1.60	1.80	0.055	0.063	0.071
D	2.70	2.90	3.10	0.106	0.114	0.122
E	0.30	0.40	0.60	0.012	0.016	0.024
F	0.07	0.127	0.20	0.003	0.005	0.008
b	0.30	0.40	0.50	0.012	0.016	0.020
e	--	0.95	--	--	0.037	--
θ	0°	5°	10°	0°	5°	10°

Marking Instruction

