

# FLM0910-15F

## X-Band Internally Matched FET

### FEATURES

- †High Output Power: P<sub>1dB</sub>=42.0dBm(Typ.)
- †High Gain: G<sub>1dB</sub>=7.5dB(Typ.)
- †High PAE: η<sub>add</sub>=32%(Typ.)
- †Broad Band: 9.5~10.5GHz
- †Impedance Matched Z<sub>in</sub>/Z<sub>out</sub> = 50Ω
- †Hermetically Sealed Package

### DESCRIPTION

The FLM0910-15F is a power GaAs FET that is internally matched for standard communication bands to provide optimum power and gain in a 50Ω system.

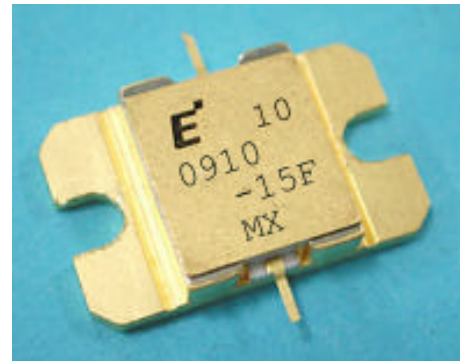

### ABSOLUTE MAXIMUM RATINGS (Case Temperature T<sub>c</sub>=25°C)

Item	Symbol	Rating	Unit
Drain-Source Voltage	V <sub>DS</sub>	15	V
Gate-Source Voltage	V <sub>GS</sub>	-5	V
Total Power Dissipation	P <sub>T</sub>	57.7	W
Storage Temperature	T <sub>stg</sub>	-65 to +175	°C
Channel Temperature	T <sub>ch</sub>	175	°C

### RECOMMENDED OPERATING CONDITION (Case Temperature T<sub>c</sub>=25°C)

Item	Symbol	Condition	Limit	Unit
DC Input Voltage	V <sub>DS</sub>		10	V
Forward Gate Current	I <sub>GF</sub>	R <sub>G</sub> =50 ohm	16.7	mA
Reverse Gate Current	I <sub>GR</sub>	R <sub>G</sub> =50 ohm	-3.62	mA

### ELECTRICAL CHARACTERISTICS (Case Temperature T<sub>c</sub>=25°C)

Item	Symbol	Condition	Limit			Unit
			Min.	Typ.	Max.	
Drain Current	I <sub>DSS</sub>	V <sub>DS</sub> =5V, V <sub>GS</sub> =0V	-	7.2	10.8	A
Trans conductance	g <sub>m</sub>	V <sub>DS</sub> =5V, I <sub>D</sub> =3.5A	-	4500	-	mS
Pinch-off Voltage	V <sub>p</sub>	V <sub>DS</sub> =5V, I <sub>D</sub> =300mA	-0.5	-1.5	-3.0	V
Gate-Source Breakdown Voltage	V <sub>GSO</sub>	I <sub>GS</sub> =-300uA	-5.0	-	-	V
Output Power at 1dB G.C.P.	P <sub>1dB</sub>	V <sub>DS</sub> =10V I <sub>D</sub> =0.5I <sub>DSS</sub> (typ.) f= 9.5 ~ 10.5 GHz Z <sub>S</sub> =Z <sub>L</sub> =50 ohm	41.0	42.0	-	dBm
Power Gain at 1dB G.C.P.	G <sub>1dB</sub>		6.5	7.5	-	dB
Drain Current	I <sub>DSR</sub>		-	4.0	5.0	A
Power-added Efficiency	η <sub>add</sub>		-	32	-	%
Gain Flatness	ΔG		-	-	1.2	dB
Thermal Resistance	R <sub>th</sub>	Channel to Case	-	2.3	2.6	°C/W
Channel Temperature Rise	ΔT <sub>ch</sub>	10V x I <sub>DSR</sub> X R <sub>th</sub>	-	-	100	°C

CASE STYLE : IB

G.C.P.: Gain Compression Point, S.C.L.: Single Carrier Level

ESD	Class III	2000V ~
-----	-----------	---------

# FLM0910-15F

## X-Band Internally Matched FET

OUTPUT POWER v.s. FREQUENCY

Vds=10V, Ids=0.5Idss

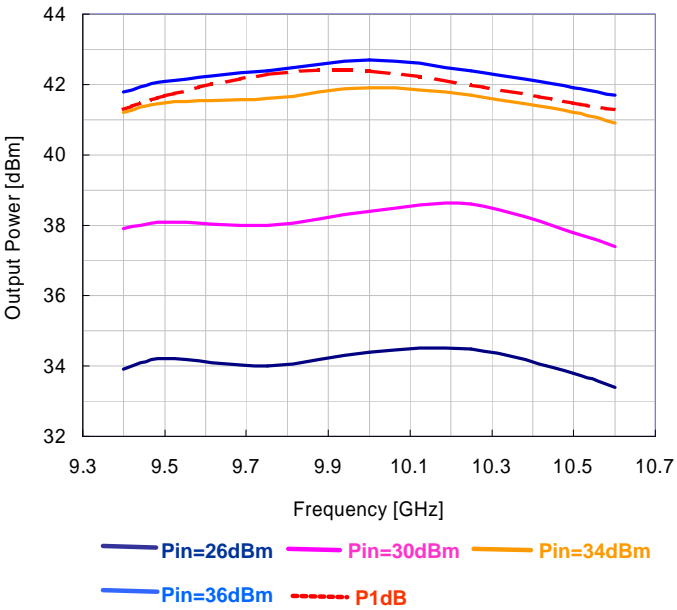

OUTPUT POWER , POWER ADDED EFFICIENCY v.s. INPUT POWER

Vds=10V, Ids=0.5Idss

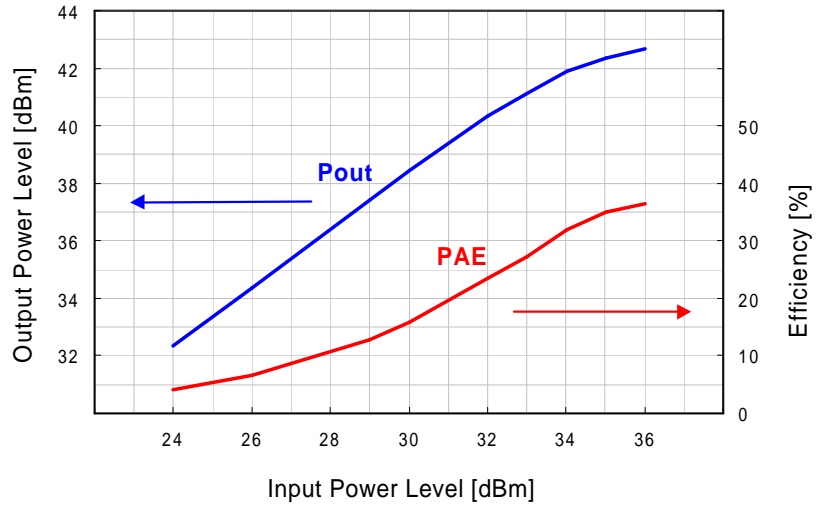

DRAIN CURRENT v.s. INPUT POWER

Vds=10V, Ids=3.6A

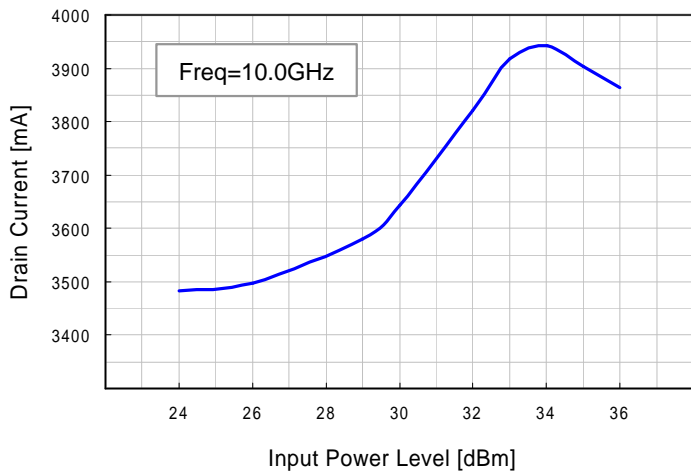

# FLM0910-15F

X-Band Internally Matched FET

## S-PARAMETERS

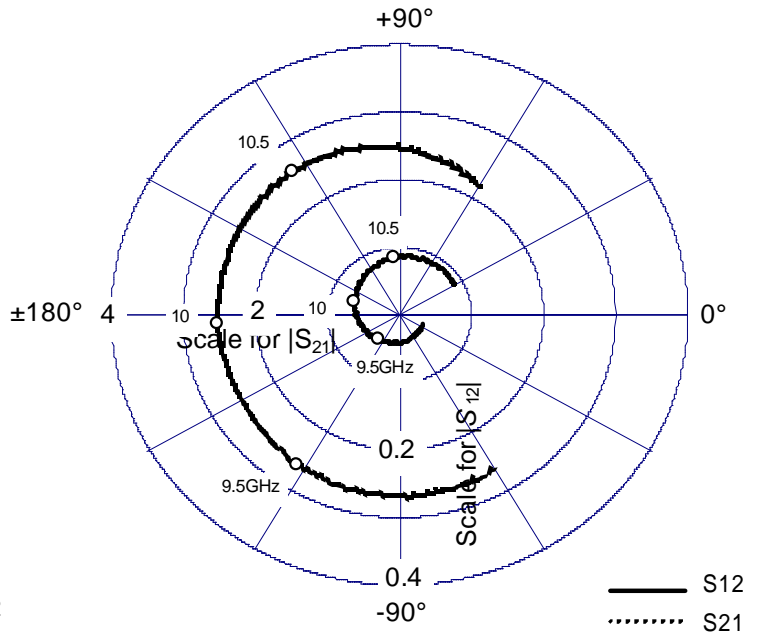
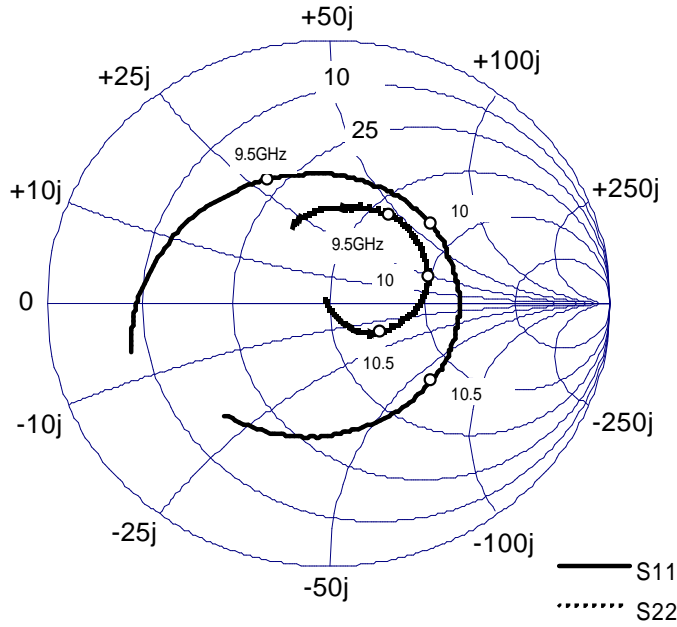

$V_{DS}=10.0V$  ,  $I_{DS}=0.5I_{DSS}$

Freq. [GHz]	S11		S21		S12		S22	
	mag	ang	mag	ang	mag	ang	mag	ang
9.3	0.589	147.4	2.678	-98.7	0.041	-88.1	0.374	77.2
9.4	0.544	130.9	2.649	-111.1	0.043	-107.6	0.387	67.0
9.5	0.520	114.6	2.618	-122.5	0.046	-127.3	0.397	57.8
9.6	0.498	98.6	2.569	-134.0	0.049	-141.0	0.401	49.7
9.7	0.488	83.8	2.538	-144.9	0.054	-155.7	0.396	41.6
9.8	0.477	68.8	2.524	-155.2	0.059	-169.5	0.390	33.1
9.9	0.474	54.6	2.509	-165.9	0.061	177.5	0.380	24.6
10.0	0.471	39.4	2.524	-176.9	0.066	163.5	0.368	15.6
10.1	0.467	25.4	2.514	172.4	0.069	149.1	0.349	7.1
10.2	0.462	10.4	2.519	161.2	0.073	136.4	0.321	-1.2
10.3	0.463	-4.6	2.553	150.2	0.077	121.6	0.290	-10.1
10.4	0.468	-21.7	2.563	137.9	0.083	109.8	0.250	-20.5
10.5	0.469	-39.2	2.591	125.3	0.085	95.4	0.215	-30.7
10.6	0.478	-58.6	2.554	112.4	0.088	84.0	0.174	-40.2
10.7	0.488	-77.5	2.514	98.8	0.090	69.4	0.126	-48.5

# FLM0910-15F

## X-Band Internally Matched FET

Package Out Line

Case Style : IB

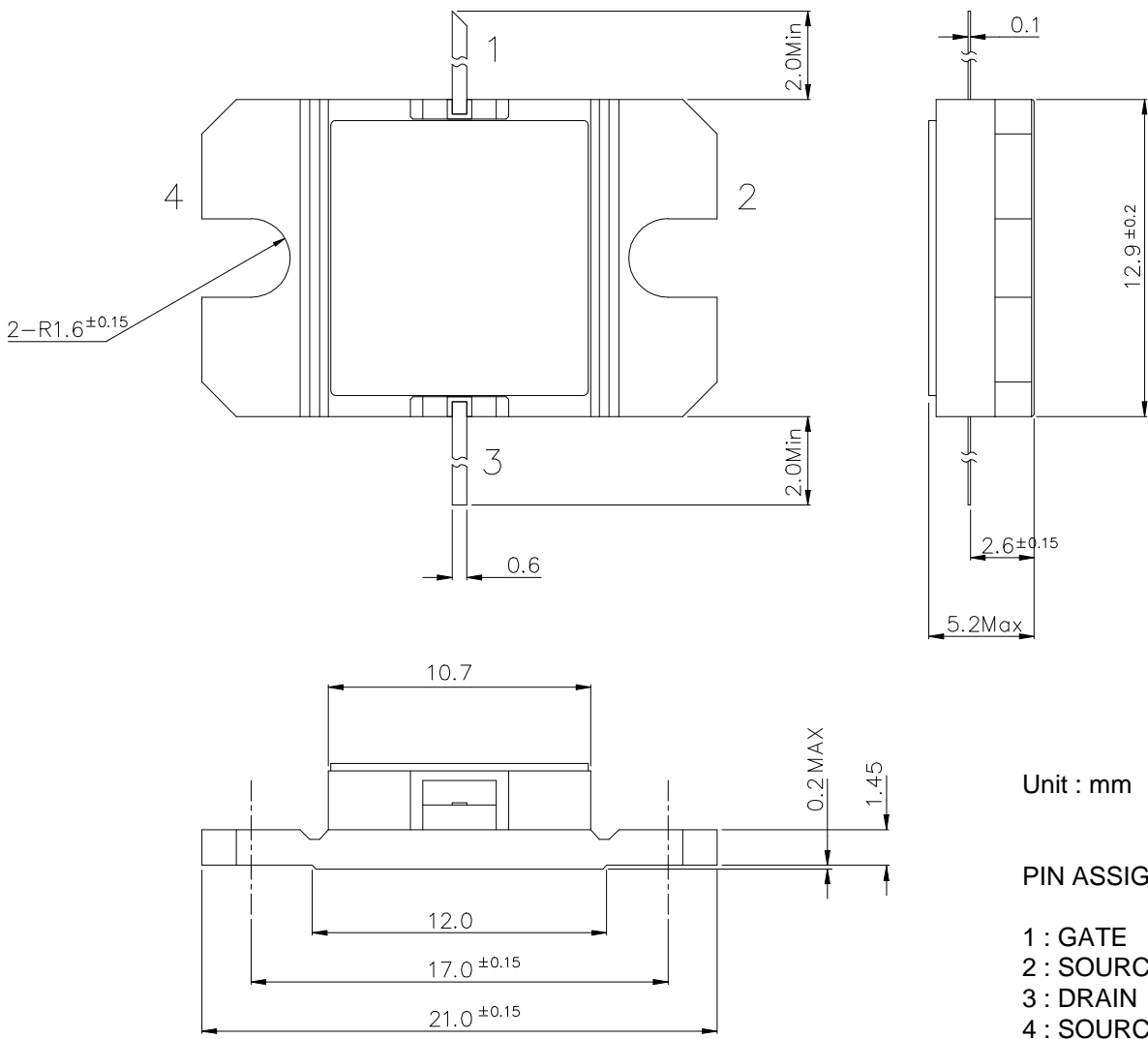

---

---

---

# **FLM0910-15F**

## **X-Band Internally Matched FET**

### **For further information please contact :**

#### **Eudyna Devices USA Inc.**

2355 Zanker Rd.  
San Jose, CA 95131-1138, U.S.A.  
Phone: (408) 232-9500  
FAX: (408) 428-9111  
www.fcsi.fujitsu.com

#### **Eudyna Devices Europe Ltd.**

Network House  
Norreys Drive  
Maidenhead, Berkshire SL6 4FJ  
Phone: +44 (0) 1628 504800  
FAX: +44 (0) 1628 504888

#### **Eudyna Devices Asia Pte. Ltd. Hong Kong Branch**

Rm.1906B, 19/F, Tower 6, China Hong Kong City,  
33 Canton Road,  
Tsim Sha Tsui, Kowloon,  
Hong Kong  
Tel: (852) 2377-0227  
Fax: (852) 2377-3921

#### **Eudyna Devices International s.r.l**

Via Teglio 8/2-20158 Milano Italy  
TEL:+39-02-8738-1695

#### **Eudyna Devices Inc.**

1000 Kamisukiahara, showa-cho, Nakakomagun, Yamanashi  
409-3883, Japan  
(Kokubo Industrial Park)  
Tel +81-55-275-4411  
Fax +81-55-275-9461

#### **Sales Division**

1, Kanai-cho, Sakae-ku, Yokohama, 244-0845, Japan  
Tel +81-45-853-8156  
Fax +81-45-853-8170

#### **CAUTION**

Eudyna Devices Compound Semiconductor Products contain **gallium arsenide (GaAs)** which can be hazardous to the human body and the environment.

For safety, observe the following procedures:

·Do not put these products into the mouth.

·Do not alter the form of this product into a gas, powder, or liquid through burning, crushing, or chemical processing as these by-products are dangerous to the human body if inhaled, ingested, or swallowed.

·Observe government laws and company regulations when discarding this product. This product must be discarded in accordance with methods specified by applicable hazardous waste procedures.

---

