

FM4933 thru FM4937

1. FEATURES

- * Plastic package has Underwriters Laboratory Flammability Classification 94V-0
- * High temperature metallurgically bonded construction
- * For use in high frequency rectifier circuits
- * Fast switching for high efficiency
- * Cavity-free glass passivated junction
- * Capable of meeting environmental standards of MIL-S-19500
- * 1.0 A operation at TA=75°C with no thermal runaway
- * Typical IR less than 1.0μA
- * High temperature soldering guaranteed: 260°C/10 seconds

2. Mechanical Data

Case: JEDEC DO-214AC, molded plastic over glass body

Terminals: Plated axial leads, solderable per MIL-STD-750, Method 2026

Polarity: Color band denotes cathode end

Mounting Position: Any

Weight: 0.002 oz., 0.061 g

Handling precaution: None

3. Electrical Characteristic

Maximum Ratings & Thermal Characteristics Ratings at 25°C ambient temperature unless otherwise specified.

Parameter Symbol	symbol	FM 4933	FM 4934	FM 4935	FM 4936	FM 4937	Unit
Maximum repetitive peak reverse voltage	V_{RRM}	50	100	200	400	600	V
Maximum RMS voltage	V_{RMS}	35	70	140	280	420	V
Maximum DC blocking voltage	V_{DC}	50	100	200	400	600	V
Maximum average forward rectified current 0.375" (9.5mm) lead length at $T_A = 75^\circ\text{C}$	$I_{F(AV)}$	1.0					A
Peak forward surge current 8.3ms single half sine-wave superimposed on rated load (JEDEC Method)	I_{FSM}	30					A
Typical thermal resistance (Note 2)	$R_{\theta JA}$	55					°C/W
Operating junction and storage temperature range	T_J, T_{STG}	-50 to +150					°C

Surface Mount Glass Passivated Fast Recovery Rectifiers

Reverse Voltage 50 to 600V
Forward Current 1.0A

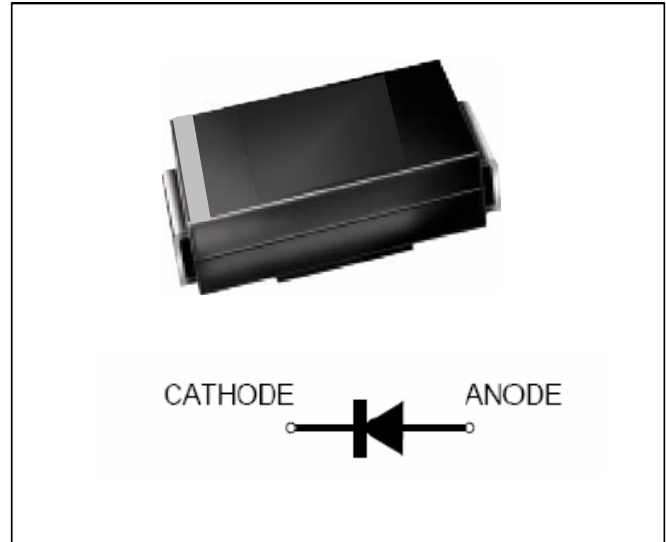

We declare that the material of product compliance with RoHS requirements.

Electrical Characteristics Ratings

at 25°C ambient temperature unless otherwise specified.

Parameter Symbol	symbol	FM 4933	FM 4934	FM 4935	FM 4936	FM 4937	Unit
Maximum instantaneous forward voltage at 1.0A	V_F	1.2					V
Maximum DC reverse current $T_A = 25^\circ\text{C}$ at rated DC blocking voltage $T_A = 125^\circ\text{C}$	I_R	5.0 100					μA
Typical reverse recovery time (Note 1)	t_{rr}	150					ns
Typical junction capacitance at 4.0V, 1MHz	C_J	15.0					PF

NOTES:

1. $I_F = 0.5A, I_R = 1.0A, I_{RR} = 0.25A$
2. Thermal resistance from junction to ambient at 0.375" (9.5mm) lead length, P.C.B. mounted

4. Ratings and Characteristic Curves (TA = 25°C unless otherwise noted)

Fig. 1 - Forward Current Derating Curve

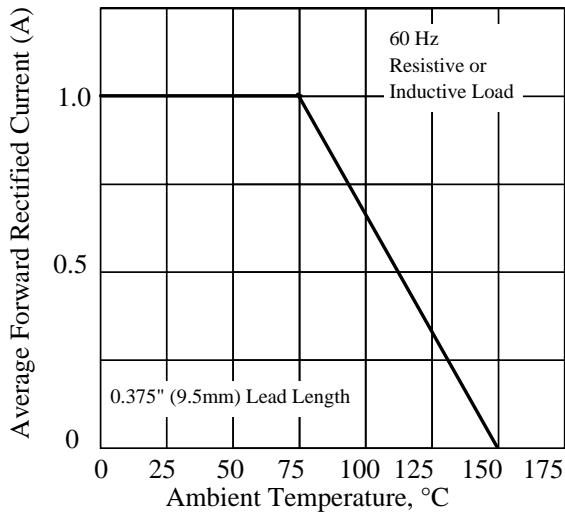

Fig. 2 - Maximum Non-repetitive Peak Forward Surge Current

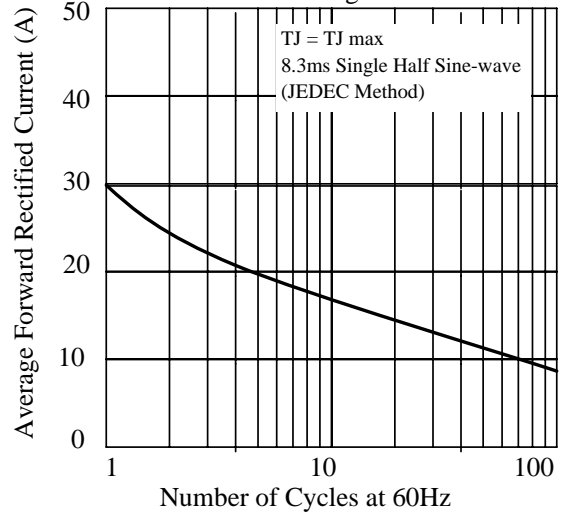

Fig 3. - Typical Instantaneous Forward Characteristics

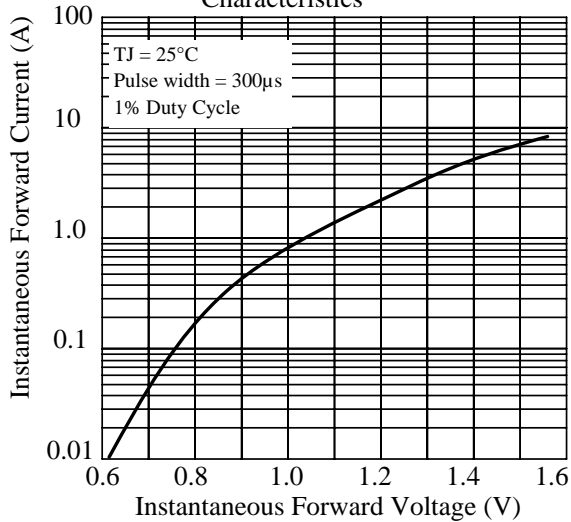

Fig 4. - Typical Reverse Characteristics

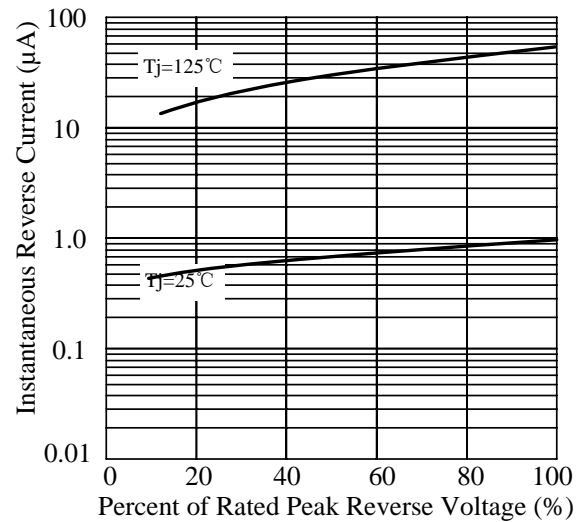

Fig 5. - typical transient thermal impedance

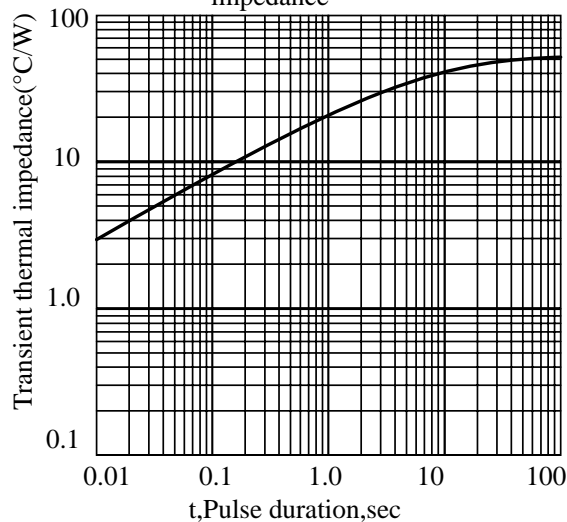
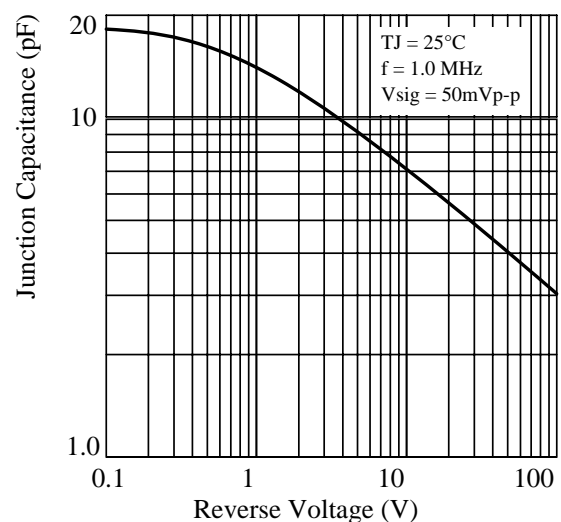
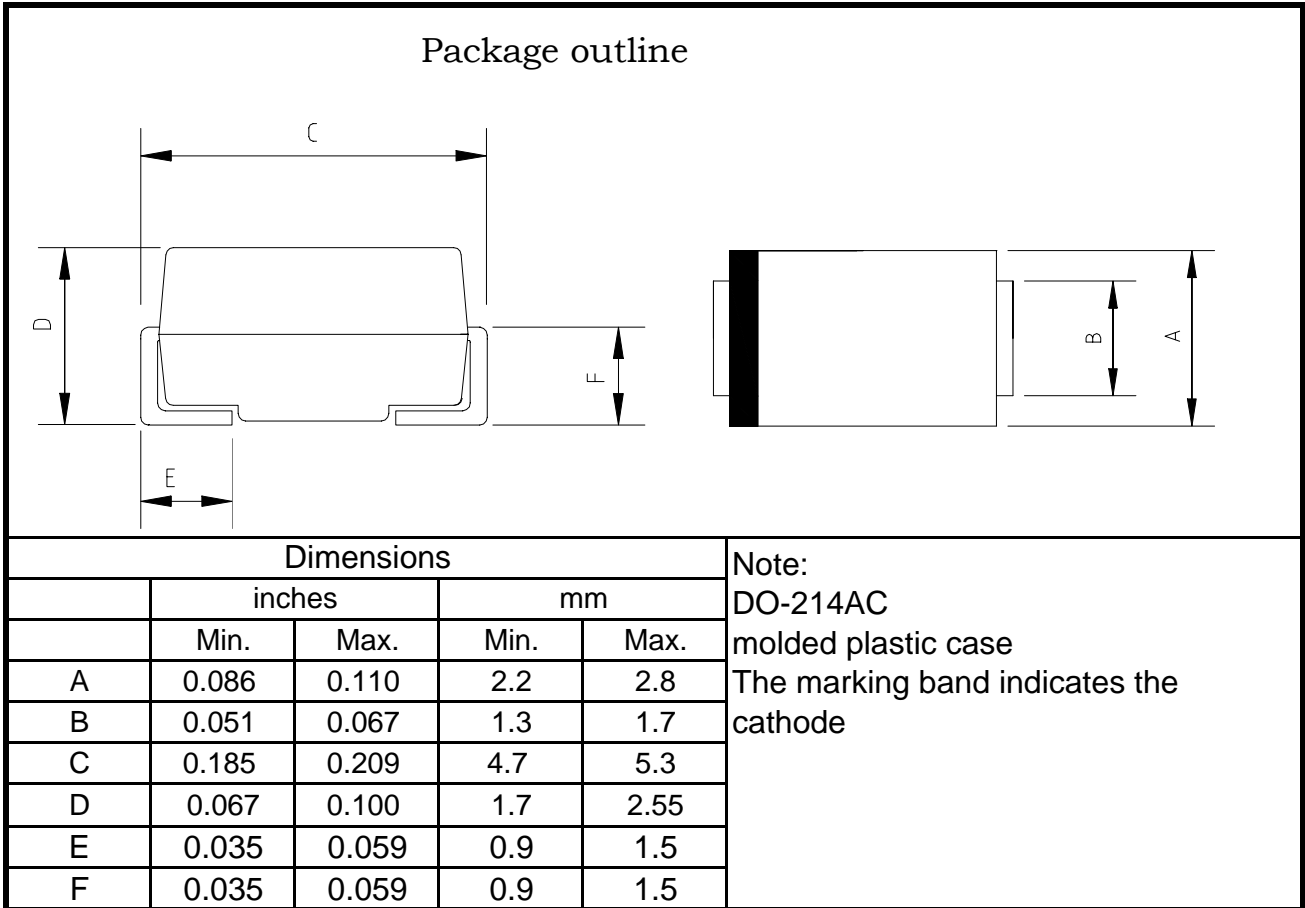

Fig 6. - Typical Junction Capacitance



5.Package Dimensions in inches and (millimeters)

SMA Packing Specification

1. 卷盘规格/Reel Packing

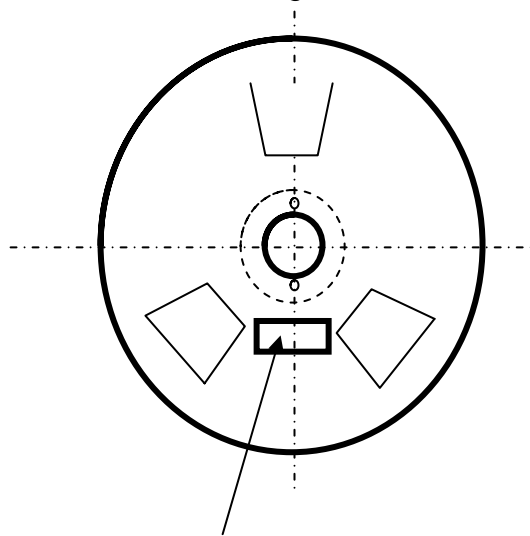

Label stike this position

Item	Q'ty/Taping
7"	2K
13"	5K

Unit:mm

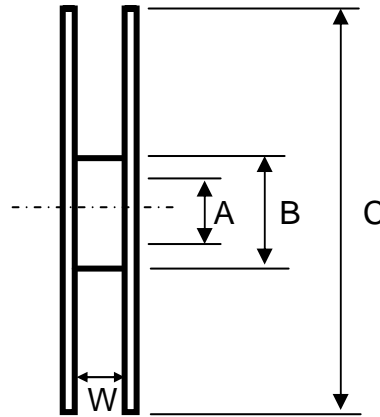

Item	Symbol	Dimension
13" Size	A	13.0±0.2
	B	75.0±0.5
	C	330±1.0
	W	13.2±1.0
7" Size	A	13.0±0.2
	B	54±0.5
	C	177±1.0
	W	13.2±1.0

2. 内箱规格/ Inside Box Specification

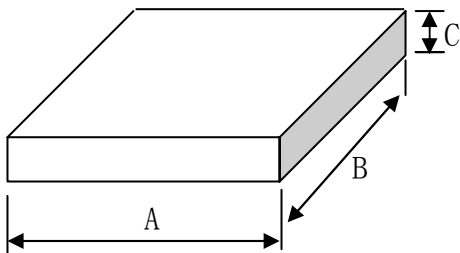

Item	Symbol	Dimension
Size	A	335±2
	B	335±2
	C	40±1

3. 外箱规格/Outer Box Specification

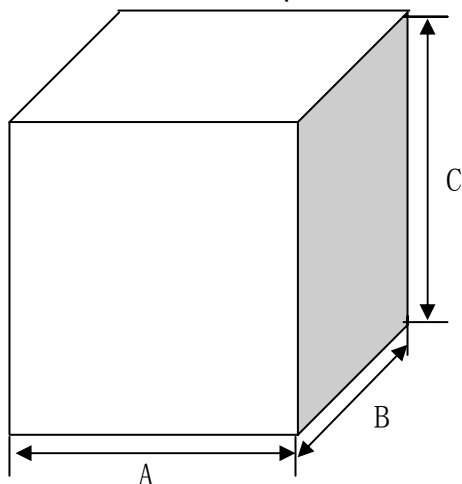

Item	Symbol	Dimension
Size	A	350±2
	B	350±2
	C	345±2