

# FMBT5550 / FMBT5551

## List

List.....	1
Package outline.....	2
Features.....	2
Mechanical data.....	2
Maximum ratings .....	2~3
Rating and characteristic curves.....	4~5
Pinning information.....	6
Marking.....	6
Suggested solder pad layout.....	6
Packing information.....	7
Reel packing.....	8
Suggested thermal profiles for soldering processes.....	8

# FMBT5550 / FMBT5551

## 600mA Silicon NPN Epitaxial Planar Transistor

### Package outline

### Features

- High collector-emitterbreakdien voltage. ( $BV_{CEO} = 140V \sim 160V @ I_C = 1mA$ )
- This device is designed for general purpose high voltage amplifiers and gas discharge display driving.
- Epitaxial planar die construction.
- Complementary PNP type available (FMBT5401)
- Lead-free parts for green partner, exceeds environmental standards of MIL-STD-19500 /228
- Suffix "-H" indicates Halogen-free part, ex.FMBT5550-H.

### Mechanical data

- Epoxy:UL94-V0 rated flame retardant
- Case : Molded plastic, SOT-23
- Terminals : Solder plated, solderable per MIL-STD-750, Method 2026
- Mounting Position : Any
- Weight : Approximated 0.008 gram

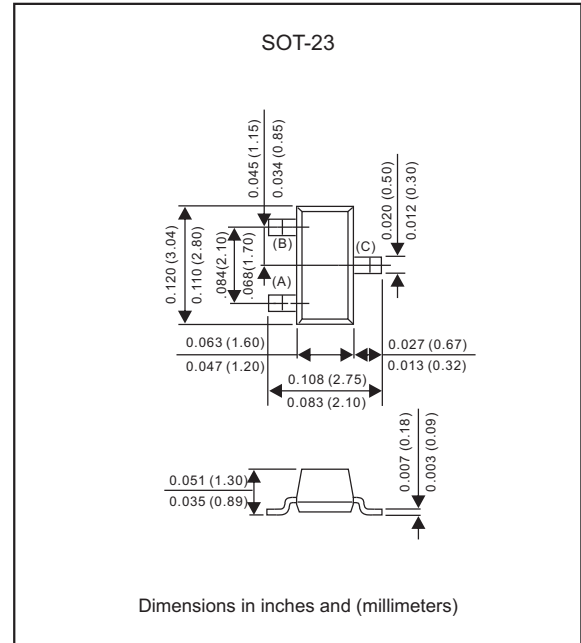

### Maximum ratings (AT $T_A = 25^\circ C$ unless otherwise noted)

PARAMETER	CONDITIONS	Symbol	FMBT5550	FMBT5551	UNIT
Collector-Base voltage		$V_{CBO}$	160	180	$V_{dc}$
Collector-Emitter voltage		$V_{CEO}$	140	160	$V_{dc}$
Emitter-Base voltage		$V_{EBO}$	6.0		$V_{dc}$
Collector current		$I_C$	600		$mA_{dc}$

### Thermal Characteristics

Characteristics	CONDITIONS	Symbol	Maximum	UNIT
Total device dissipation FR-5 board (1)	$T_A = 25^\circ C$	$P_D$	225	mW
	Derate above $25^\circ C$	$P_D$	1.8	$mW/^\circ C$
Thermal resistance	Junction to ambient	$R_{\theta JA}$	556	$^\circ C/W$
Total device dissipation alumina substrate(2)	$T_A = 25^\circ C$	$P_D$	300	mW
	Derate above $25^\circ C$	$P_D$	2.4	$mW/^\circ C$
Thermal resistance	Junction to ambient	$R_{\theta JA}$	417	$^\circ C/W$
Operating temperature		$T_J$	-55 ~ +150	$^\circ C$
Storage temperature		$T_{STG}$	-65 ~ +150	

1.FR-5 = 1.0 X 0.75 X 0.062 in.

2.Alumina = 0.4 X 0.3 X 0.024 in. 99.5% alumina.

**FMBT5550 / FMBT5551****Characteristics** (AT  $T_A=25^\circ\text{C}$  unless otherwise noted)**Off characteristics**

PARAMETER	CONDITIONS	Symbol	Types	Min.	Max.	UNIT
Collector-Base breakdown voltage	$I_c = -100\mu\text{A}_{\text{dc}}, I_E = 0$	$V_{(\text{BR})\text{CBO}}$	FM5550	160	-	$V_{\text{dc}}$
			FM5551	180	-	
Collector-Emitter breakdown voltage(3)	$I_c = 1.0\text{mA}_{\text{dc}}, I_B = 0$	$V_{(\text{BR})\text{CEO}}$	FM5550	140	-	$V_{\text{dc}}$
			FM5551	160	-	
Emitter-Base breakdown voltage	$I_E = 10\mu\text{A}_{\text{dc}}, I_C = 0$	$V_{(\text{BR})\text{EBO}}$	Both Types	6.0	-	$V_{\text{dc}}$
Collector cutoff current	$V_{\text{CB}} = 100\text{V}_{\text{dc}}, I_E = 0$	$I_{\text{CBO}}$	FM5550	-	100	$\text{nA}_{\text{dc}}$
	$V_{\text{CB}} = 120\text{V}_{\text{dc}}, I_E = 0$		FM5551	-	50	
	$V_{\text{CB}} = 100\text{V}_{\text{dc}}, I_E = 0, T_A = 100^\circ\text{C}$		FM5550	-	100	$\mu\text{A}_{\text{dc}}$
	$V_{\text{CB}} = 100\text{V}_{\text{dc}}, I_E = 0, T_A = 100^\circ\text{C}$		FM5551	-	50	
Emitter cutoff current	$V_{\text{EB}} = 4.0\text{V}_{\text{dc}}, I_C = 0$	$I_{\text{EBO}}$	Both Types	-	50	$\text{nA}_{\text{dc}}$

**On characteristics(3)**

PARAMETER	CONDITIONS	Symbol	Types	Min.	Max.	UNIT
DCcurrent gain	$I_c = 1.0\text{mA}_{\text{dc}}, V_{\text{CE}} = 5.0\text{V}_{\text{dc}}$	$h_{\text{FE}}$	FM5550	60	-	-
			FM5551	80	-	
	$I_c = 10\text{mA}_{\text{dc}}, V_{\text{CE}} = 5.0\text{V}_{\text{dc}}$		FM5550	60	250	
			FM5551	80	250	
	$I_c = 50\text{mA}, V_{\text{CE}} = 10\text{V}_{\text{dc}}$		FM5550	20	-	
			FM5551	30	-	
Collector-Emitter saturation voltage(3)	$I_c = 10\text{mA}_{\text{dc}}, I_B = 1.0\text{mA}_{\text{dc}}$	$V_{\text{CE}(\text{sat})}$	Both Types	-	0.15	$V_{\text{dc}}$
	$I_c = 50\text{mA}_{\text{dc}}, I_B = 5.0\text{mA}_{\text{dc}}$		FM5550	-	0.25	
			FM5551	-	0.20	
Base-Emitter saturation voltage(3)	$I_c = 10\text{mA}_{\text{dc}}, I_B = 1.0\text{mA}_{\text{dc}}$	$V_{\text{BE}(\text{sat})}$	Both Types	-	1.0	$V_{\text{dc}}$
	$I_c = 50\text{mA}_{\text{dc}}, I_B = 5.0\text{mA}_{\text{dc}}$		FM5550	-	1.2	
			FM5551	-	1.0	

3.Pulse test : pukse width &lt; 300uS, duty cycle &lt; 2.0%.

# FMBT5550 / FMBT5551

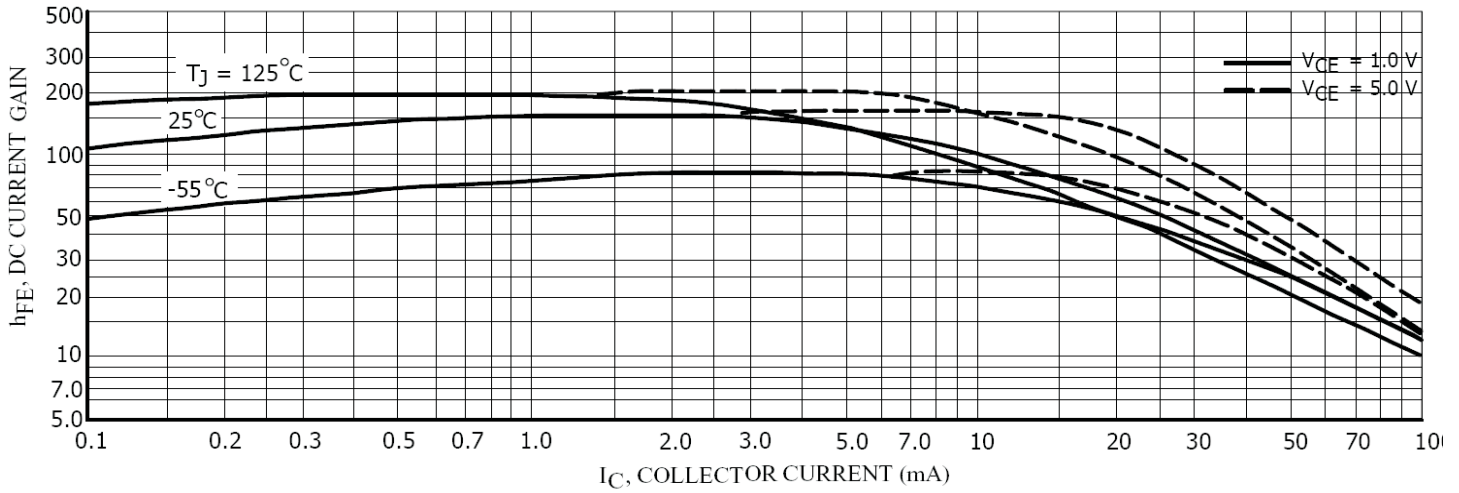

FIG.1 DC Current Gain

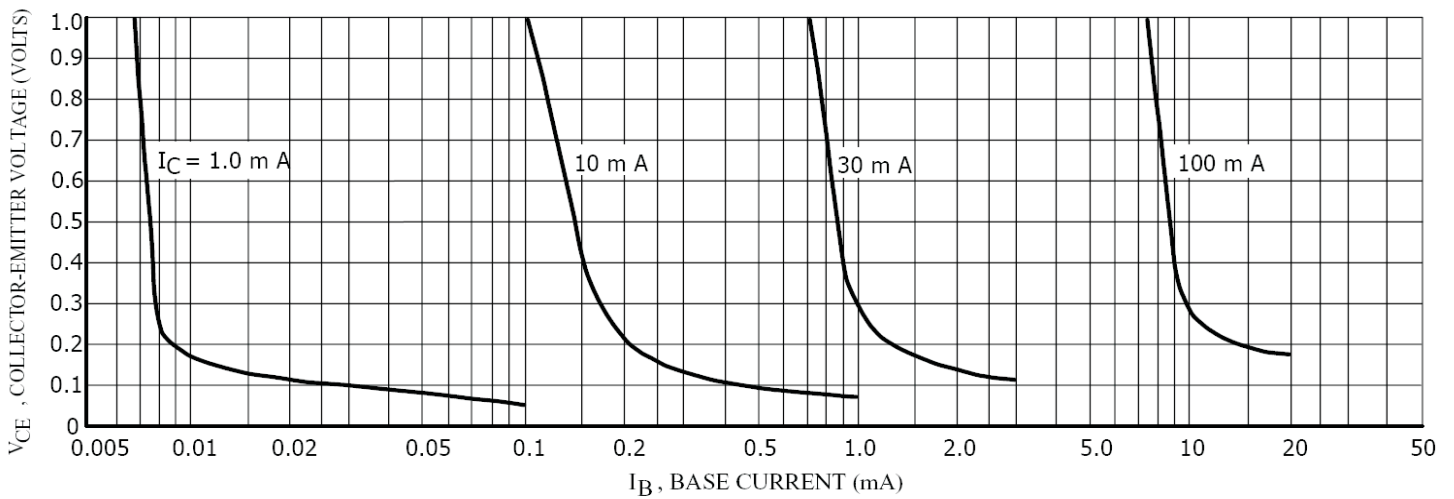

FIG. 2 Collector Saturation Region

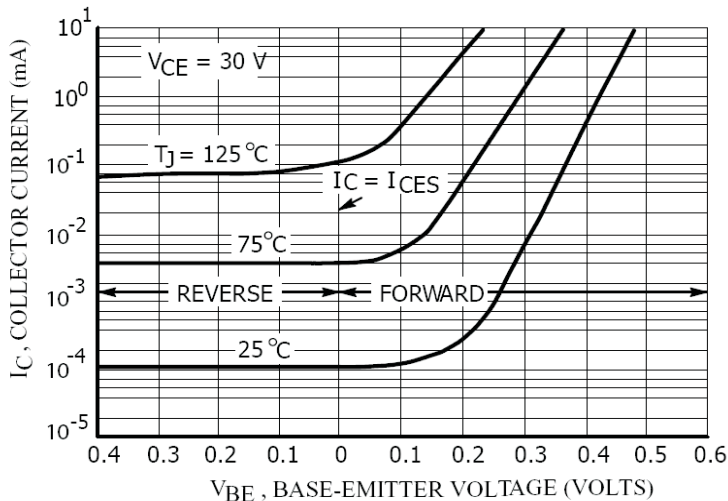

FIG. 3 Collector Cut-Off Region

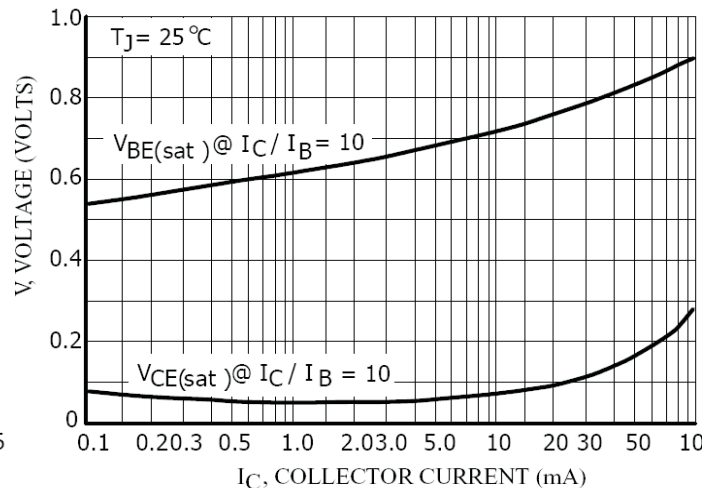

FIG. 4 "On" Voltages

# FMBT5550 / FMBT5551

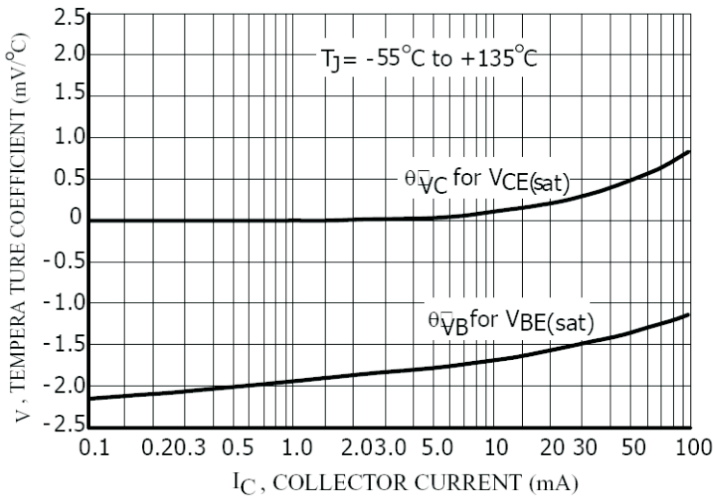
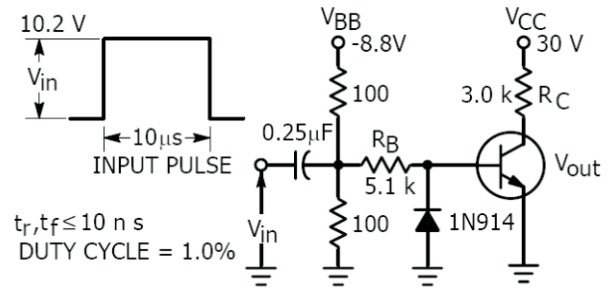

FIG.5 Temperature Coefficients



Values Shown are for  $I_C @ 10 \text{ mA}$

FIG. 6 Switching Time Test Circuit

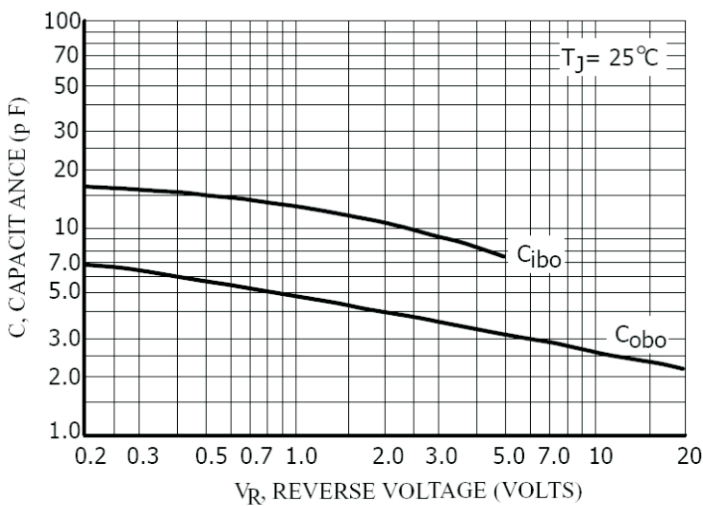

FIG. 7 Capacitances

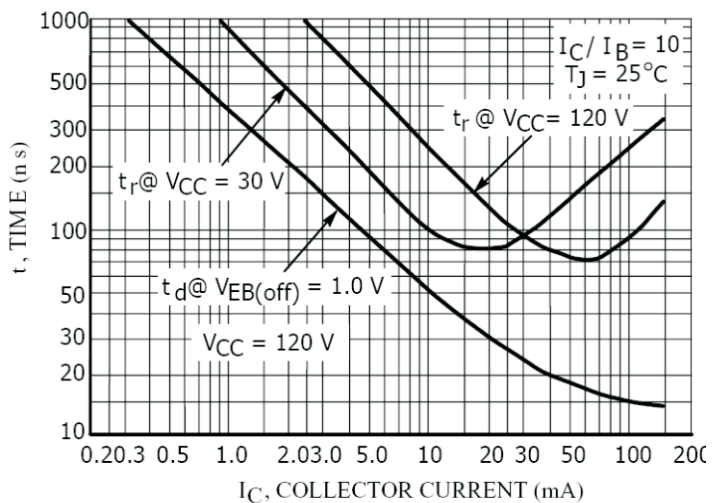

FIG. 8 Turn-On Time

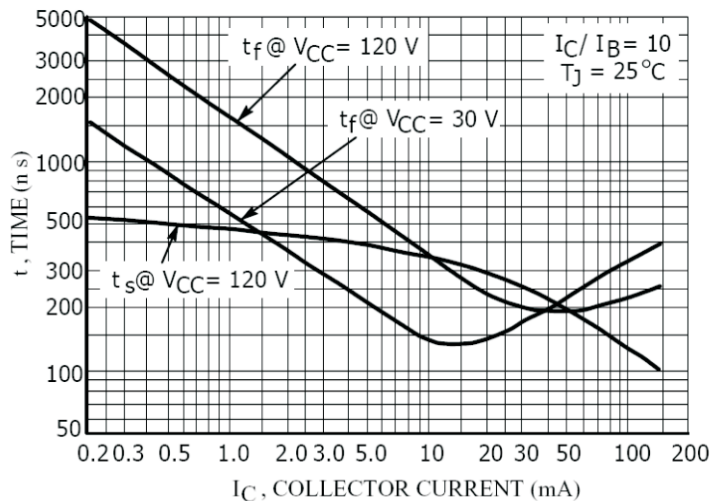
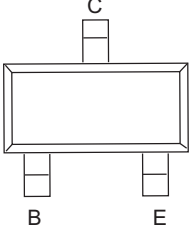
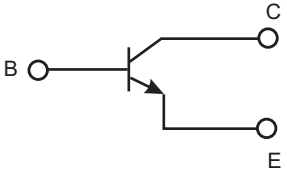

FIG.9 Turn-Off Time

# FMBT5550 / FMBT5551

## Pinning information

Pin	Simplified outline	Symbol
PinB Base PinC Collector PinE Emitter		

## Marking

Type number	Marking code
FMBT5550	M1F
FMBT5551	G1

## Suggested solder pad layout

SOT-23

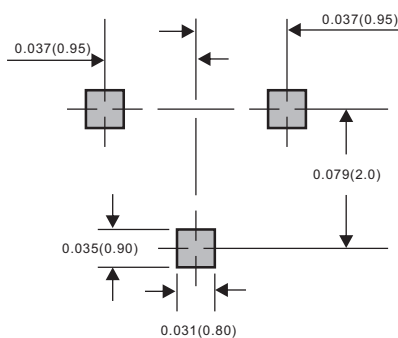

Dimensions in inches and (millimeters)

# FMBT5550 / FMBT5551

## Packing information

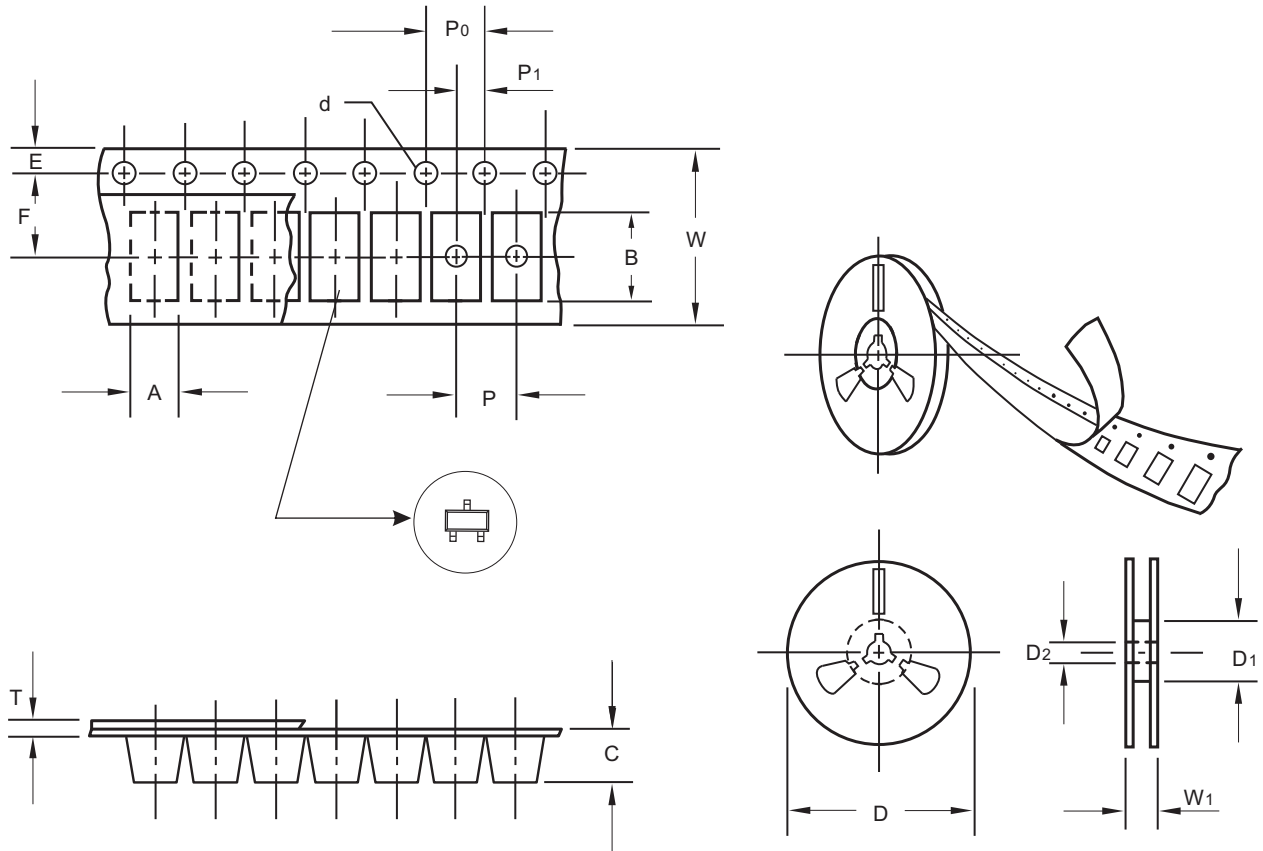

unit:mm

Item	Symbol	Tolerance	SOT-23
Carrier width	A	0.1	3.15
Carrier length	B	0.1	2.77
Carrier depth	C	0.1	1.22
Sprocket hole	d	0.1	1.50
13" Reel outside diameter	D	2.0	-
13" Reel inner diameter	D1	min	-
7" Reel outside diameter	D	2.0	178.00
7" Reel inner diameter	D1	min	55.00
Feed hole diameter	D2	0.5	13.00
Sprocket hole position	E	0.1	1.75
Punch hole position	F	0.1	3.50
Punch hole pitch	P	0.1	4.00
Sprocket hole pitch	P0	0.1	4.00
Embossment center	P1	0.1	2.00
Overall tape thickness	T	0.1	0.23
Tape width	W	0.3	8.00
Reel width	W1	1.0	12.0

Note: Devices are packed in accordance with EIA standard RS-481-A and specifications listed above.

# FMBT5550 / FMBT5551

## Reel packing

PACKAGE	REEL SIZE	REEL (pcs)	COMPONENT SPACING (m/m)	BOX (pcs)	INNER BOX (m/m)	REEL DIA, (m/m)	CARTON SIZE (m/m)	CARTON (pcs)	APPROX. GROSS WEIGHT (kg)
SOT-23	7"	3000	4.0	30,000	183*183*123	178	383*262*387	240,000	11.6

## Suggested thermal profiles for soldering processes

- 1.Storage environment: Temperature=5°C~40°C Humidity=55%±25%
- 2.Reflow soldering of surface-mount devices

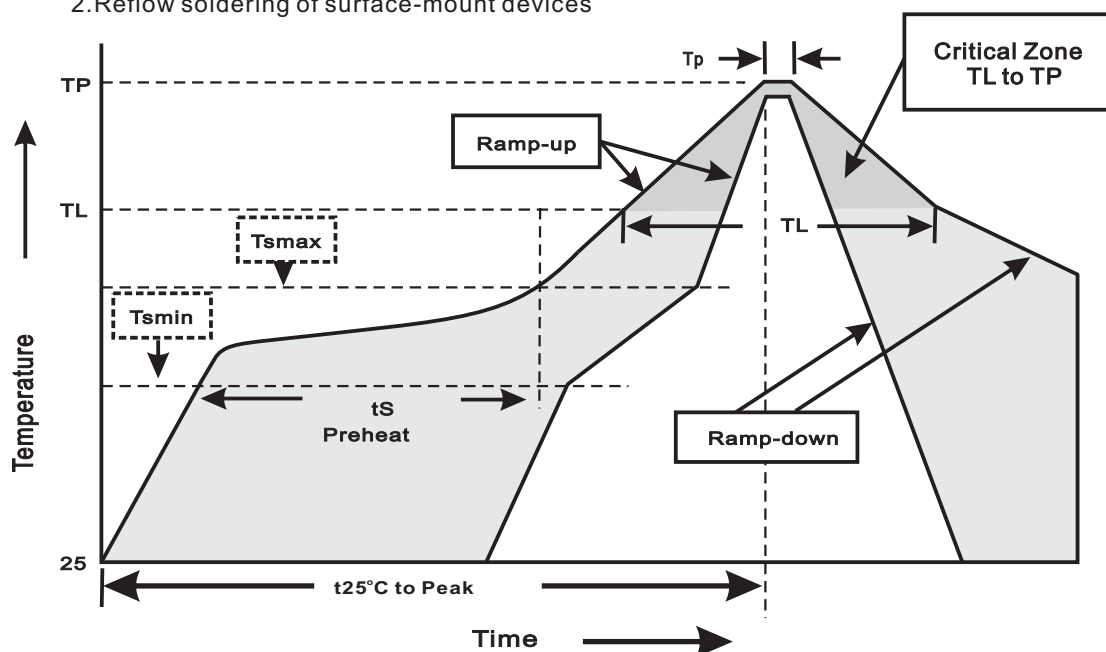

### 3.Reflow soldering

Profile Feature	Soldering Condition
Average ramp-up rate(T <sub>L</sub> to T <sub>P</sub> )	<3°C/sec
Preheat -Temperature Min(T <sub>min</sub> ) -Temperature Max(T <sub>max</sub> ) -Time(min to max)(t <sub>s</sub> )	150°C 200°C 60~120sec
T <sub>max</sub> to T <sub>L</sub> -Ramp-upRate	<3°C/sec
Time maintained above: -Temperature(T <sub>L</sub> ) -Time(t <sub>L</sub> )	217°C 60~260sec
Peak Temperature(T <sub>P</sub> )	255°C-0/+5°C
Time within 5°C of actual Peak Temperature(t <sub>P</sub> )	10~30sec
Ramp-down Rate	<6°C/sec
Time 25°C to Peak Temperature	<6minutes