

MANUAL

GMDSS Marine Radio Decoder

FMD25

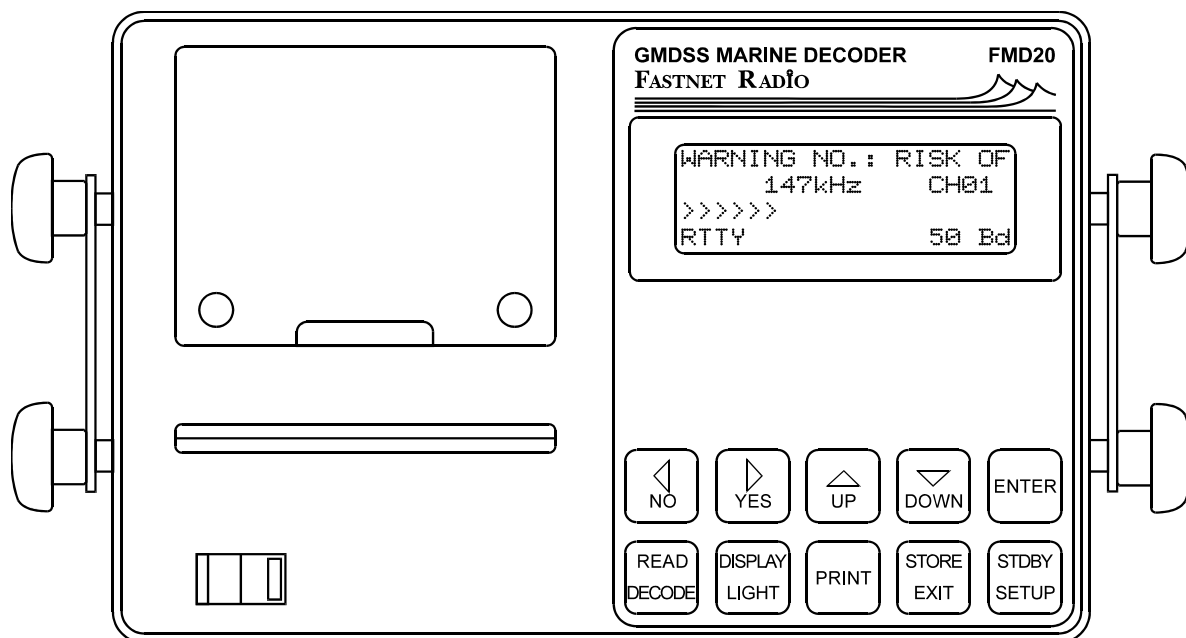

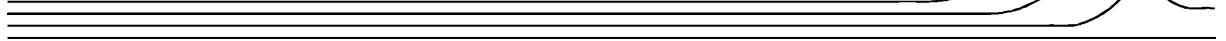



1. Programming the Timer function



Call the Setup menu from the default position

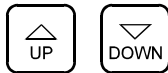

set the Cursor to position Timer



call the Timer function

1.1. Input a new ON-/OFF time with channel frequency



activate the Timer-Program for input



set the ON time hour



go to ON time minutes and set



go to OFF time hours and set



go to OFF time minutes and set



go to channel (receiving frequency) and set



enter the ON an OFF time and Channel to the Timer

1.2. Delete a Timer function



call deleting a row



set number of row to be deleted



confirm deleting or



exit



exit the Timer function



exit the Setup-Menu



2. Recall stored messages



call the menu READ MEMORY

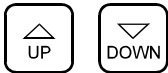

set Cursor to the desired messages
RD NAVTEX : stored NAVTEX messages
RD CH x : all stored messages from Timer function



call function (Navtex resp. CHx)

2.1. Reading of NAVTEX messages via RD NAVTEX

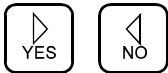

select the desired NAVTEX message



show the selected message on the display
The single messages are stored with the NAVTEX identifier
i.e. JA54 1. figure = transmitting station
2. figure = type of message
following number is number of message



scroll through the message



print the displayed message

















select other messages



exit the RD NAVTEX menu



2.2. Reading weather forecast messages via RD CH x

- | | |
|---|---|
|   | select the channel |
|  | call the selected channel
the stored messages will be displayed
with date and time
(i.e. 27030829 = 27. March, 08:29 Uhr/UTC)
corresponding with the ON time of the timer |
|   | select the desired message |
|  | show the selected message on the display |
|   | scroll trough the message |
|  | print the selected message |
|  | printing can be cancelled |
|   | other messages can be selected |
|  | exit the menue RD CH x |
|  | go back to the STDBY mode |



3. Changing the receiving frequency (Channel)



call the Setup menu from the default position

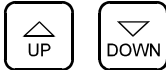

set the Cursor to the position Channel



call the Channel function



go to the Channel to be changed



activate the channel for changing



set the thousand position to the new frequency



go to the hundred position and set



go to the ten position and set



go to the unit position and set



go to the tenth unit and set



go to the hundreds unit and set



exit the menu CHANNEL



return to STDBY mode



Table of Contents

1. Introduction

1.1. Short description	1 - 1
1.2. Operation	1 - 1
1.3. Keypad functions	1 - 2

2. Receiver

2.1. Operation	2 - 1
2.2. North Sea, Baltic Sea and North-Atlantik frequencies	2 - 2
2.3. Mediterranean and North-Atlantic frequencies	2 - 2

3. Deciding of messages

3.1. Selecting mode and decoding	3 - 1
3.2. Programming channels	3 - 3
3.3. Recalling channels	3 - 4
3.4. Message memory	3 - 5

4. Automatic reception and decoding

4.1. Programming the timer functions	4 - 1
4.1.1. Input of new on/off times	4 - 2
4.1.2. Deleting on/off timer	4 - 3
4.2. Interrupting and restarting the timer	4 - 3
4.3. Reading stored messages	4 - 4
4.4. Printing out stored messages	4 - 5

5. NAVTEX reception and decoding

5.1. Selection of fre	5 - 1
5.2. Selection of transmitting stations	5 - 2
5.3. Selecting type of message	5 - 3
5.4. Printer function	5 - 4
5.5. Supressing repeated messages	5 - 4
5.6. Alarm for A, B and D messages	5 - 4
5.7. Print out of parameter status	5 - 5
5.8. Returning to standby mode	5 - 5
5.9. Displaying and dealing with errors	5 - 5
5.10. Termination by high error rate	5 - 5
5.11. Current list of NAVTEX transmission stations	5 - 6



6. nicht belegt

7. NMEA Printer and navigations log

- 7.1. Printing of NMEA data 7 - 1
- 7.2. Activating position log 7 - 2

8. System set up

- 8.1. Setting of time and data 8 - 1
- 8.2. Setting of owner's and ship's name 8 - 1
- 8.3. Print out of system data 8 - 2
- 8.4. Memory deletion and reset 8 - 3

9. Installation

- 9.1. Packing contents 9 - 1
- 9.2. Installation of unit 9 - 1
 - Dimensions..... 9 - 3
 - Desktop installation and wall installation 9 - 4
- 9.3. Power supply connection 9 - 5
- 9.4. NMEA interface connection 9 - 5
- 9.5. Antenna and earth connection 9 - 6
 - Installation with Long-Wire and Balun 9 - 7
 - Installation with Active-Antenna 9 - 8
 - Installation with Active-Antenne R+R 9 - 9
- 9.6. Printer paper change 9 - 10
- 9.7. Active antenna power supply 9 - 12
- 9.8. Audio output 9 - 12

10. FMD20 accessories

- 10.1. 24V DC/DC converter 10 - 1
- 10.2. Converter installation 10 - 1
- 10.3. DC936-12 DC/DC converter from 9V-36V to 12V 10 - 2
- 10.4. MD-AA active antenna for FMD20, 50 and 55 10 - 3
- 10.5. MLB marine long-wire balun for after stay 10 - 4
- 10.6. F3A / F6A suppression filter 10 - 5
- 10.7. M20-ALS - active loudspeaker for FMD20 10 - 6



11. Technical Data

11.1. General	11 - 1
11.2. Receiver	11 - 1
11.3. Microcontroller	11 - 1
11.4. Signalconverter - Decoder	11 - 2
11.5. LCD Display	11 - 2
11.6. Printer	11 - 2
11.7. NMEA interface	11 - 2
11.8. Supply for Avtive Antenne	11 - 2
11.9. Approvals	11 - 2

12. Informationen Stationen, Empfangsbedingungen

12.1. Stationen, Frequenzen und Sendezeiten	12 - 1
12.2. Chart W3 United Kingdom GMDSS Metarea 1.....	12 - 2
12.3. Chart W4 United Kingdom Forcast Areas	12 - 3
12.4. Chart W5 Baltic Sea	12 - 4
12.5. Chart W6 Germany Forcast Areas	12 - 5
12.6. Chart W8 Denmark Forcast Areas	12 - 6
12.7. Chart W12 France Forcast Areas	12 - 7
12.8. Chart W18 Greece Forcast Areas	12 - 8
12.9. Chart W19 Mediterranean Fleet Forcast Areas	12 - 9
12.10. Bezeichnungen für Windstärke	12 - 10
12.11. Bezeichnungen für Seegang	12 - 11
12.12. Propagation of SW Signals	12 - 12
12.13. Empfangsantennen auf Schiffen	12 - 13
12.14. MORSE Code Table	12 - 15

13. Examples

13.1. Example North-Atlantik / North-Baltic Sea	13 - 1
13.2. Example North-Atlantik/East-West Mediterranean Sea	13 - 2
13.3. Example NAVTEX Printout	13 - 3
13.4. Example of Weather Report	13 - 4
13.5. Example Printout Navigation Log	13 - 5
13.6. Example NAVTEX Status-Information	13 - 5



14. Addendum

14.1 Service and Maintenance	14 - 1
14.2. Service Organisation	14 - 1
14.3. Gewährleistung	14 - 2
14.4. Firmware Update	14 - 3
14.5. Fehlermeldungen	14 - 3
14.5.1. Fehlermeldung : „PRINTER-ERROR“	14 - 3
14.5.2. Sonstige akustische Fehlermeldungen	14 - 4
Anforderungsschein Firmware Update	14 - 5

1. Introduction

1.1. Short description

The Fastnet Marine Decoder contains the following functions:

a)Receiver

a high quality receiver with the following important features:

- Range : 8 free programmable channels
: from 100 kHz to 11,8 MHz
- Modes : FSK and CW
- Memory stores : 8 frequencies with modes

b) NAVTEX receiver and decoder

- Frequencies : 490.0 and 518.0 kHz

c) Morse, Telex and SITOR decoder

By means of a PLL signal processor and an integrated micro-computer the following codes are automatically deciphered:

- Morse code signs : 40 to 100 Bpm
- RTTY(radio telytype) : 50 Baud
- SITOR FEC : 100 Baud (NAVTEX)

d) NMEA printer and navigation log

Print out of data via the NMEA interface. When connected to a GPS, a navigation log can be stored and printed out.

1.2. Operation

The back-lit, high contrast LCD display and an easy to use keypad, allow a user friendly operation of the FMD25. System information and stored decoded messages can be printed out by the integrated thermal printer on 80 mm wide paper.



1.3. Keypad functions

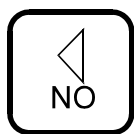

- cursor to the left
- answer <NO>



- cursor to the right
- answer <YES>



- cursor upwards
- scroll upwards
- increase number



- cursor downwards
- scroll downwards
- decrease number



- confirm entry
- activate the position of cursor

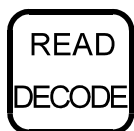

- read memory contents
- start decoding

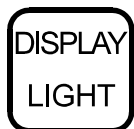

- display memory contents
- switch on back lighting



- start printing
- select (P) print and/or (W) write



- confirm input
- return to higher menu level
- end process



- return to standby mode
- recall SETUP menu

2. Receiver

2.1. Operation

The receiver requires practically no operation.

The NAVTEX frequencies (490.0 and 518.0 kHz) are pre-programmed. The choice between the two can be made in the NAVTEX menu (see chapter 5).

Further this model has 8 free programmable frequencies according to a defined sailing region.

The frequencies of a transmitting station are normally set down internationally and are rarely changed. However, each pre-programmed frequency has been allotted the following parameters:

■ Decoding mode

- Morse
- RTTY
- SITOR

The message decoding mode has not been laid down, as it is expected, that, in the next few years, various stations will change their transmission from Morse to RTTY or RTTY to SITOR respectively. On the following pages you can find a list of the present codes used.

It is not necessary to adjust the mode in the receiver. This is done automatically, when selecting the decoding mode.



2.2. North Sea, Baltic Sea and North-Atlantic frequencies

FMD25 North Sea, Baltic Sea and North-Atlantic version

channel	frequency(kHz)	code	station
01	147,3	RTTY	Pinneberg
02	438,0	Morse	Lyngby
03	6.315,0	SITOR	Portishead
04	4.583,0	RTTY	Pinneberg
05	7.646,0	RTTY	Pinneberg
06	4.211,0	SITOR	Portishead
07	8.417,0	SITOR	Portishead
08	10.100,8	RTTY	Pinneberg

2.3. Mediterranean and North-Atlantic frequencies

FMD25 Mediterranean and North-Atlantic version

channel	frequency(kHz)	code	station
01	4.292,0	Morse	Roma Meteo
02	4.343,0	Morse	Athen
03	6.315,0	SITOR	Portishead
04	6.964,0	Morse	Bandirma
05	7.646,0	RTTY	Pinneberg
06	8.530,0	Morse	Roma Meteo
07	11.039,0	RTTY	Pinneberg
08	10.100,8	RTTY	Pinneberg



3. Decoding of messages

The FMD25 can store and decipher MORSE, RTTY and SITOR codes, which then can be read or printed out in plain language. In radio signal traffic there are many other kinds of keyed codes. As they are not for use by the general public, they cannot be decoded by the FMD25.

Weather and navigational warnings for shipping are transmitted in one of the above mentioned codes, which can be decoded by the FMD25.

The received signal tone (LF) is fed to a PLL signal decoder, which filters out the audio signals and turns them into digital information. This in turn will be converted into legible symbols by the integrated micro-processor.

The type of code used by the individual station, can be found in the appropriate manuals for marine radio stations. The codes used vary:

- for MORSE also : CW,A1,A1A, telegraphy
- for RTTY also : F1B, telex
- for SITOR also : FEC,F1B

3.1. Selecting mode and decoding

In various manuals, the type of code used by a station is shown mostly as A1A, F1B etc. The following list is an overlook of types of transmission generally used in marine radio transmission. The required adjustment to receiver and decoder are also listed



Message Transmission Types

Transmission mode	receiver set up	decoder set up
A1A - Morse telegraphy with undamped carrier e.g. Lyngby, Roma IAR etc.	*	Morse
A2A - Morse telegraphy in double sideband method	*	Morse
A3E - audio radio in double sideband e.g. BBC, DLF etc.	*	*
F1B - FM telex signal from Pinneberg	*	RTTY
F1B - FM telex signal specially for NAVTEX	*	SITOR
F1B - FM telex (MSI frequencies e.g. Portishead: 4211 kHz (402))	*	SITOR
F1C - FM telefax from Bracknell, Pinneberg etc.	*	*
F3E - VHF Audio radio from 88 to 108 MHz	*	*
H3E - AM audio radio, SSB with carrier e.g. Murmansk	*	*
J3E - SSB audio radio	*	*
R3R - as H3E however with reduced carrier e.g. Niton	*	*

*- not available with FMD25

3.2. Programming channels

■ Press  to enter set-up menu

■ Point cursor with button<**DOWN**> to **5 CHANNELS** and press <**ENTER**>.

Display shows :

CH	FREQ	MODE	WR	PR
1	147	RTTY	Y	N
2	438	MORSE	Y	N
3	6.315	RTTY	Y	N

The following parameters can be assigned to each channel:

- Mode (Morse, RTTY, SITOR) **MODE**
- store decoded messages **WR**
- print out decoded messages **PR**

This is done as follows :

- using <**UP**> and <**DOWN**> to point cursor to select the appropriate column (**MODE**, **WR**, **PR**)
 - press <**ENTER**> at selected column. To select type of code, scroll with the same button to shift from **RTTY** to **SITOR** to **MORSE** and return to **RTTY** and so on.
 - to select **WR** and **PR** use <**ENTER**> similarly to select between **N**(NO) and **Y**(YES)

Y - in column **WR** means that the message will be stored

Y - in column **PR** means that the message will be printed out simultaneously.

After checking that the parameters and the desired set up is correct, return to NAVTEX standby mode by pressing <EXIT> twice.

3.3. Recalling channels

■ to recall a channel press   twice

the following picture appears on the display:
e.g. North Sea, Baltic Sea, Atlantic version

1R	147	5R	7.646
2M	438	6S	4.211
3S	6.315	7S	8.417
4R	4.583	8R	10.100

1 ... 8 represent the channel number
R / M / S represent **RTTY/MORSE/SITOR**
followed by the frequency in kHz

- set the cursor to the requested channel by means of <UP> an <DOWN>
- confirm by pressing <ENTER>

For instance, should you have chosen channel 5, the following picture will be displayed :

—	7.646kHz	CH05
>>>		
RTTY		50 Bcd

This means that the receiver is receiving on the 7646 kHz frequency. The arrows show the strength of the reception signal. With six or more arrows, you can expect reasonable decoding. The bottom line shows that the code being used is RTTY (Radio Tele Type) at a transmission rate of 50 Baud/m.



After a short phase for the decoder to synchronise, the decoded text will appear on the top line.

According to the selected mode in 3.2., the decoded text can only be read in the display or stored in the memory and printed out.

The selection can be altered by pressing button **<PRINT>**. The following functions for selection will appear on the bottom line:

- _ _ display only
- P _ display and print simultaneously
- _ W display and store simultaneously
- P W display, store and print simultaneously.

This will not influence the mode selection in 3.2.

3.4. Message memory

The FMD25 possesses two separate independent memory stores. One for NAVTEX messages (see chap.5) and one for Morse, RTTY and SITOR messages.

The latter has a capacity of about 15000 characters. A message of maximum 3750 characters can be stored in a data record. Should a message be longer, further data records will be automatically opened. All in all, 100 data records can be filed with a total capacity of 15000 characters. Should the memory store be full, a new message will be stored by replacing the oldest messages. The most up-to-date messages will always be available whether decode from Morse, RTTY or SITOR.

It can happen that a new message of only a few characters replaces the oldest message containing 3750 characters. At this moment the store contents have been reduced to 11250 characters.



On completion of the message, every data record will be stored with a identification in form of date and time (DDMMhhmm). Further each data record will be given the information from which channel (CH) the message was received, this enables messages to be recalled chronologically.

Should the FMD25 be switched off during storage, whether deliberately or not (e.g. power interruption), the actual data record will not be stored because of lack of end of file identifier.

Because of strong disturbance (e.g. starting the motors with weak batteries), it can happen that the identification of data records may be partly or completely deleted. In this case, it may be possible to read messages only partly or not at all. On restarting the unit it can happen that all messages in the memory are deleted for safety reasons, because the unit cannot recognise the identifications.

Thereafter newly decoded messages will be stored correctly.

4. Automatic reception and decoding

The FMD25 has a timer function for the storage of 9 programmes. Each storage contains a starting time, stop time and the channel number of a stored frequency (similar to that in a video recorder). The transmission times of weather messages can be found in the usual manuals but to be on the safe side it is recommended to add some time before and after the start/stop times.

For reference the following transmission times can be used:

- MORSE transmissions approx. 30 mins.
- RTTY transmissions approx. 15 mins.
- SITOR transmissions approx. 10 mins

The FMD25 will automatically switch to the required frequency at the selected start time and will decode according to the input parameters. The decoded message will be stored, according to the parameters, in the assigned channel if "W" was answered with <Y>. It will be directly printed out if "P" was answered with <Y>. (See chap. 8 - System parameter input).

On reaching the stop time, the FMD25 will switch back automatically into standby mode (i.e. the basic mode for NAVTEX reception). Before programming the timer the assignment channels must be programmed. (See chap. 3.2.)

4.1. Programming the timer function

Starting from standby mode

- press button  to call up menu 1

- use button  to select TIMER

■ press 

4.1.1. Input of new on/off times

■ press  once more

On the display will appear:

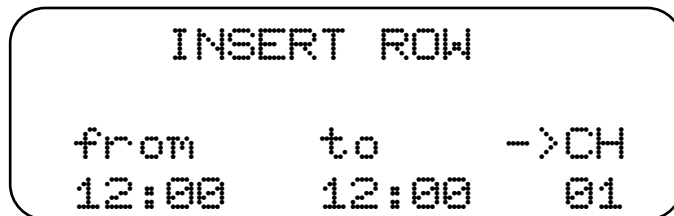

Use the cursor buttons



to enter the required start and stop times and the channel number. The buttons **<NO>** and **<YES>** move the cursor to the required position. The buttons **<UP>** and **<DOWN>** change the figure value.

Buttons **<UP>** and **<DOWN>** have an auto-repeat function, which means the selected value will increase or decrease in steps as long as the button is depressed. As long as you have not pressed **<ENTER>** you can change the value as often as required. Having checked that all values are correct press **<ENTER>**. By pressing **<ENTER>** once more you can enter further programme rows.



4.1.2. Deleting on/off times

Call up TIMER menu as in 4.1.1.

■ Press button 

On display will appear:

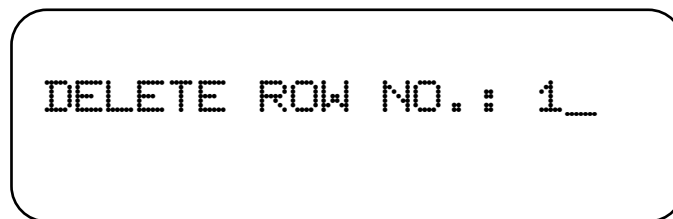

Use the cursors **<UP>** and **<DOWN>** to select the number of the row to be deleted and activate by pressing **<ENTER>**. To leave the TIMER mode without a row deletion, press **<EXIT>**.

Press **<EXIT>** once more to return to the standby mode

The maximum length of time in the timer function is 60 minutes. However it is possible to put in the same start time as the previous stop time. In the case where to programmed times overlap, the newer start time is dominant

Should a timer function be interrupted by manual operation e.g. calling up another frequency, the unit will still return to standby mode on reaching the stop time

4.2. Interrupting and restarting the timer



An actual timer programme can be interrupted by pressing the **<STDBY>** button. The unit will switch back automatically to the standby mode at the respective stop time. It is possible to restart the unit during operation by switching it off for approx. 3 to 5 seconds. When switched on the unit returns to its programmed status.



4.3. Reading stored messages

Stored messages can be read on the display as often as desired. The complete data record store disposes of more than 20000 characters. Of this amount approx. 5500 are reserved for NAVTEX messages, the rest for Morse, RTTY and SITOR together. When the storage space is full, the oldest message will be automatically deleted. However this is done separately for NAVTEX and other messages. Meaning that the oldest NAVTEX message cannot be replaced by a new RTTY message, only by a new NAVTEX message and vice versa. Each message is identified by date and time in the following form: DD MM HH MM (day, month, hour, minutes).

■ Press button  to recall **READ MEMORY**

■ use buttons  and  to select the type of message to be read (**NAVTEX** or **RD CH x**) and press **<ENTER>**

■ press button  once more

The display will now show, when in NAVTEX, the list of messages with NAVTEX identification (e.g. JA34), and when in **RD CH x**, the list of frequencies.

In the latter case select the desired channel with the cursors **<UP>** and **<DOWN>** and press **<ENTER>**.

The display will show the stored messages by date and stop time in number sequence DD MM hh mm (Day, month, hour minutes).



Place cursor on selected message.

- press now the button  and the message appears on the display.
- buttons <UP> and <DOWN> enable you to "turn the pages". On reaching the end of the message or by pressing <EXIT>, the read out will end.
- by pressing <EXIT> once more you will return to standby mode.

4.4. Printing out stored messages

Stored messages can be printed out as often as required.

Select the message to be printed out as **READ MEMORY** (see 4.3.)

- press button  to call up **READ MEMORY**
- select message to be printed out
- by pressing button  the message will be printed out from start to finish.
- Printing can be stopped by pressing <EXIT>

It is possible to print only a part of the message e.g. only the sector applicable to your sailing region. This is done as follows:

- press button <DISPLAY> and message appears on display. "turn the pages" with the cursors <UP> and <DOWN>
- by pressing <PRINT> the printer will commence from the displayed page
- press <EXIT> when required or allow printing to continue until the message has ended
- press <EXIT> twice to return to standby mode

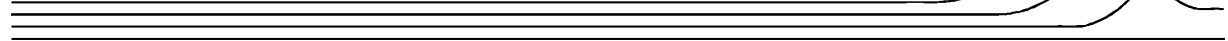

5. NAVTEX reception and decoding

When the unit is in standby mode, it is automatically operating as a NAVTEX receiver and therefore a manual activation is not necessary

ATTENTION:

During the reception of other stations, also when receiving a message programmed to be stored by the timer, NAVTEX cannot be received.

However, depending on your position, you should put in the necessary system parameters to enable the best possible NAVTEX information.

Input of the parameters is done as follows:

- press button <**SET UP**> to call up set up menu
- with cursor <**DOWN**> spring to position **4 - NAVTEX**
- press <**ENTER**> to enter **NAVTEX** menu

Display will show

1	FREQU.	5	REPEAT
2	STATION	6	ALARM
3	MESSAGE	7	STATUS
4	PRINT	8	EXIT

5.1. Selection of frequency

The FMD25 is programmed at present to receive two international NAVTEX frequencies:

518 kHz for coastal regions in English and

490 kHz for coastal regions in the local language

■ press <ENTER> to call up **FREQUENCY** menu

use the cursors <UP> and <DOWN> to select the frequencies 490.00 kHz or 518.00 kHz. The frequency 518 kHz has been chosen as basic adjustment.

Fine tuning is unnecessary, as the PLL decoder compensates frequency deviation.

■ press button  to return to NAVTEX menu.

The frequency which appeared last on the display has been stored and is active in standby mode.

5.2. Selection of transmitting stations

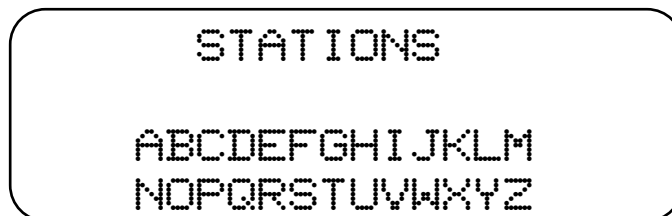

■ With cursor <DOWN> spring to position **2 - STATION**

■ press button No. 2 to enter and the display will show:



NAVTEX stations are identified by the letters -**A**- to -**Z**-. Stations from which messages should be received are represented by capital letters, and stations from which messages should be suppressed with small letters.

■ use the cursors   to select an individual letter

■ use the cursors   to change the letters from capitals to small

An up-to-date list of NAVTEX transmission stations (October 2006) can be found at the end of this chapter.



- having checked that all adjustments are correct press button to return to NAVTEX menu. The selected adjustment will be stored.

5.3. Selecting type of message

- select menu position **-3- MESSAGE** and press **<ENTER>**

Similar to station selection , the messages are identified by letters and the selection is analogue.

The international definition of the letters is

- A** = navigational warnings
- B** = meteorological warnings
- C** = ice reports
- D** = SAR information
- E** = meteorological prognosis
- F** = pilot service messages
- G** = DECCA messages
- H** = LORAN messages
- I** = OMEGA messages
- J** = SATNAV messages
- K** = messages about other electronic navigational assistance
- L** = additional navigational warnings
- V - Y** special services, tests
- Z** = no message available

Messages of type **-A-**, **-B-** and **-D-** cannot be suppressed.

- by pressing button  selection will be stored and return to **NAVTEX** menu.



5.4. Printer function

- select menu position **-4- PRINTER** and press **<ENTER>**

You can select now whether you wish the message to be printed out while being received or stored to be printed out on desire by answering with buttons **<YES>** and **<NO>**.

- by pressing button  the selection will be stored and unit returns to NAVTEX menu.

5.5. Suppressing repeated messages

Current NAVTEX messages are transmitted repeatedly usually every 6 or 8 hours. A repeat message, which has already been stored and printed out, can be suppressed.

- select menu position **-5- REPEAT** and press **<ENTER>**

Answer the question with **<YES>** or **<NO>** and

- store with button 

5.6. Alarm for A, B and D messages

Should the FMD25 receive messages of the type A, B or D they can be alerted with an acoustic alarm.

- select menu position **-6- ALARM** and press **<ENTER>**

If you wish alarm activated for A, B and D type messages press **<YES>**

- press  to store and return to NAVTEX menu.



5.7. Print out of parameter status

For your own control you can print out the input of the parameters

- select menu position **-7- STATUS** and press **<ENTER>**

You will receive a simple and clear print out, making it easy to control, that all input parameters are correct.

5.8. Returning to standby mode

This can be done either by pressing the button  twice or:

- select menu position **-8- EXIT** and press **<ENTER>**

The display will now show the standby mode.

5.9. Displaying and dealing with errors

The SITOR code used by NAVTEX can recognise errors. Every data field, to which a character has been assigned, will be repeated and have a relationship of 4:3 bit. Only when both data fields match and are valid does the corresponding character appear as a capital letter. Should it be recognised as valid only once, then it will appear as a small letter. If both assigned data field characters be non-valid, then it will appear as an * (asterisk). It is not common form of expression. We are of the opinion that a small letter holds more information than an asterisk.

5.10. Termination by high error rate

When deciphering NAVTEX, the error rate of the decoded signal will be examined. Should the acceptance rate be exceeded, then the print out, if activated, will be interrupted and the message will be automatically deleted from the storage.

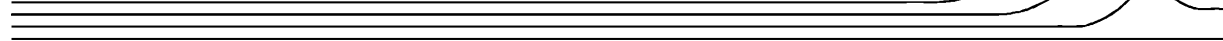

NAVTEX STATIONS SORTED BY COUNTRY:

Last updated: 20th of October 2006

490 kHz:

page 1 of 8

Country:	COU:	kHz:	Slot:	Call:	Station Name:	Transmission Times - All in UTC:	Latitude:	Longitude:	Range nm:	Area:	Lang:	Status:
Azores	AZR	490,0	[J]	CTH	Horta	0130, 0530, 0930, 1330, 1730, 2130	38° 32' N	28° 38' W	640	II	PP	active
Canada	CAN	490,0	[D]	VCK	Riviere-au-Renard, QC	0035, 0435, 0835, 1235, 1635, 2035	50° 11' N	66° 07' W	300	IV	FF	active
Canada	CAN	490,0	[J]	VCO	Sydney, NS	0255, 0655, 1055, 1455, 1855, 2255	46° 11' N	59° 54' W	300	IV	FF	active
Canada	CAN	490,0	[S]	VFF	Iqaluit, NU	0300, 0700, 1100, 1500, 1900, 2300	63° 44' N	68° 33' W	150	IV	FF	active
Canada	CAN	490,0	[V]	VAR-3	Fundy, NB	0335, 0735, 1135, 1535, 1935, 2335	43° 45' N	66° 10' W	300	IV	FF	active
Canary Isles	CNR	490,0	[A]	EAL	Las Palmas	0000, 0400, 0800, 1200, 1600, 2000	28° 09' N	15° 25' W		II	SS	on trial
Cape Verde	CPV	490,0	[P]	D4A	Sao Vicente	0230, 0630, 1030, 1430, 1830, 2230	16° 51' N	25° 00' W	250	II	EE	active
Ecuador	EOA	490,0	[A]		Ayora	0000, 0400, 0800, 1200, 1600, 2000	00° 45' S	90° 19' W	250-400	XII	SS	active
England	ENG	490,0	[T]	GNI	Niton	0310, 0710, 1110, 1510, 1910, 2310	50° 35' N	01° 18' W	270	I	FF	active
England	ENG	490,0	[I]	GNI	Niton	0520, 1720	50° 35' N	01° 18' W	270	I	EE	active
England	ENG	490,0	[U]	GCC	Cullercoats	0720, 1920	55° 04' N	01° 28' W	270	I	EE	active
France	FRA	490,0	[E]	FRC	CROSS Corsen	0040, 0440, 0840, 1240, 1640, 2040	48° 24' N	05° 03' W	300	II	FF	active
France	FRA	490,0	[S]	FRL	CROSS La Garde	0300, 0700, 1100, 1500, 1900, 2300	43° 06' N	05° 59' E	250	III	FF	active
Germany	DEU	490,0	[L]	DDH47	Pinneberg	0150, 0550, 0950, 1350, 1850, 2150	53° 43' N	09° 55' E		I	DD	active
Iceland	ISL	490,0	[R]	TFA	Reykjavik	0320, 0720, 1120, 1520, 1920, 2320	64° 05' N	21° 51' W	550	I	IS	active
Portugal	POR	490,0	[G]	CTV	Monsanto	0100, 0500, 0900, 1300, 1700, 2100	38° 44' N	09° 11' W	520	II	PP	active
Romania	ROU	490,0	[L]	YQI	Constanta	0150, 0550, 0950, 1350, 1850, 2150	44° 12' N	28° 40' E	250	III	RO	active
Scotland	SCT	490,0	[C]	GPK	Portpatrick	0820, 2020	54° 51' N	05° 07' W	270	I	EE	active
South Korea	KOR	490,0	[J]		Chukpyon	0130, 0530, 0930, 1330, 1730, 2130	37° 03' N	129° 26' E	200	XI	KO	active
South Korea	KOR	490,0	[K]		Pyonsan	0140, 0540, 0940, 1340, 1740, 2140	35° 36' N	126° 29' E	200	XI	KO	active
Spain	ESP	490,0	[M]	EAV	Valencia (Cabo de la Nao)	0200, 0600, 1000, 1400, 1800, 2200	39° 27' N	00° 20' W	300	III	SS	active
Spain	ESP	490,0	[T]	EAC	Tarifa	0310, 0710, 1110, 1510, 1910, 2310	36° 01' N	05° 35' W		II	SS	active

Country:	COU:	kHz:	Slot:	Call:	Station Name:	Transmission Times - All in UTC:	Latitude:	Longitude:	Range nm:	Area:	Lang:	Status:
Spain	ESP	490,0	[W]	EAR	Coruna	0340, 0740, 1140, 1540, 1940, 2340	43° 22' N	08° 27' W		II	SS	active
Taiwan	TWN	490,0	[V]		Lintou	0330, 0730, 1130, 1530, 1930, 2330	23° 33' N	119° 38' E	350	XI	CC	active
Taiwan	TWN	490,0	[X]	XSY	Yenliaoken	0350, 0750, 1150, 1550, 1950, 2350	23° 54' N	121° 36' E	350	XI	CC	active
Turkey	TUR	490,0	[A]	TAF	Samsun	0000, 0400, 0800, 1200, 1600, 2000	41° 17' N	36° 20' E	300	III	TT	active
Turkey	TUR	490,0	[B]	TAH	Istanbul	0010, 0410, 0810, 1210, 1610, 2010	41° 04' N	28° 57' E	300	III	TT	active
Turkey	TUR	490,0	[C]	TAN	Izmir	0020, 0420, 0820, 1220, 1620, 2020	38° 22' N	26° 36' E	300	III	TT	active
Turkey	TUR	490,0	[D]	TAL	Antalya	0030, 0430, 0830, 1230, 1630, 2030	36° 53' N	30° 42' E	300	III	TT	active
Uruguay	URG	490,0	[A]	CWM27	La Paloma	0000, 0400, 0800, 1200, 1600, 2000	34° 40' S	54° 09' W	280	VI	SS	active

518 kHz:

Country:	COU:	kHz:	Slot:	Call:	Station Name:	Transmission Times - All in UTC:	Latitude:	Longitude:	Range nm:	Area:	Lang:	Status:
Alaska	ALS	518,0	[J]	NOJ	Kodiak (east of)	0300, 0700, 1100, 1500, 1900, 2300	57° 46' N	152° 34' W	200	XII	EE	active
Alaska	ALS	518,0	[X]	NOJ	Kodiak (west of)	0340, 0740, 1140, 1540, 1940, 2340	57° 46' N	152° 34' W	200	XII	EE	active
Algeria	ALG	518,0	[B]	7TA	Alger Radio	0010, 0410, 0810, 1210, 1610, 2010	36° 40' N	03° 18' E		III	EE	active
Argentina	ARG	518,0	[A]	L3K	Ushuaia	0200, 1000, 1800	54° 48' S	68° 18' W	280	VI	SS	active
Argentina	ARG	518,0	[B]	L3D	Río Gallegos	0210, 1010, 1810	51° 37' S	69° 03' W	280	VI	SS	active
Argentina	ARG	518,0	[C]	L2W	Comodoro Rivadavia	0220, 1020, 1820	45° 51' S	67° 25' W	280	VI	SS	active
Argentina	ARG	518,0	[D]	L2I	Bahia Blanca	0230, 1030, 1830	38° 43' S	62° 06' W	280	VI	SS	active
Argentina	ARG	518,0	[E]	L2P	Mar del Plata	0240, 1040, 1840	38° 03' S	57° 32' W	280	VI	SS	active
Argentina	ARG	518,0	[F]	L2B	Buenos Aires	0250, 1050, 1850	34° 27' S	58° 37' W	560	VI	SS	active
Argentina	ARG	518,0	[M]	L3K	Ushuaia	0600, 1400, 2200	54° 48' S	68° 18' W	280	VI	EE	active
Argentina	ARG	518,0	[N]	L3D	Río Gallegos	0610, 1410, 2210	51° 37' S	69° 03' W	280	VI	EE	active
Argentina	ARG	518,0	[O]	L2W	Comodoro Rivadavia	0620, 1420, 2200	45° 51' S	67° 25' W	280	VI	EE	active
Argentina	ARG	518,0	[P]	L2I	Bahia Blanca	0630, 1430, 2230	38° 43' S	62° 06' W	280	VI	EE	active
Argentina	ARG	518,0	[Q]	L2P	Mar del Plata	0640, 1440, 2240	38° 03' S	57° 32' W	280	VI	EE	active
Argentina	ARG	518,0	[R]	L2B	Buenos Aires	0650, 1450, 2250	34° 27' S	58° 37' W	560	VI	EE	active
Azores	AZR	518,0	[F]	CTH	Horta	0050, 0450, 0850, 1250, 1650, 2050	38° 32' N	28° 38' W	640	II	EE	active
Bahrain	BHR	518,0	[B]	A9M	Hamala	0010, 0410, 0810, 1210, 1610, 2010	26° 13' N	50° 39' E	300	IX	EE	active
Belgium	BEL	518,0	[M]	OST	Oostende (Thames)	0200, 0600, 1000, 1400, 1800, 2200	51° 11' N	02° 48' E	150	I	EE	active
Belgium	BEL	518,0	[T]	OST	Oostende	0310, 0710, 1110, 1510, 1910, 2310	51° 11' N	02° 48' E	110	I	EE	active
Bermuda	BER	518,0	[B]	ZBM	Bermuda Harbour	0010, 0410, 0810, 1210, 1610, 2010	32° 23' N	64° 41' W	280	IV	EE	active

Country:	COU:	kHz:	Slot:	Call:	Station Name:	Transmission Times - All in UTC:	Latitude:	Longitude:	Range nm:	Area:	Lang:	Status:
Bulgaria	BUL	518,0	[J]	LZW	Varna	0130, 0530, 0930, 1330, 1730, 2130	43° 04' N	27° 46' E	350	III	EE	active
Canada	CAN	518,0	[C]	VCK	Riviere-au-Renard, QC	0020, 0420, 0820, 1220, 1620, 2020	50° 11' N	66° 07' W	300	IV	EE	active
Canada	CAN	518,0	[D]	VAJ	Prince Rupert, BC	0030, 0430, 0830, 1230, 1630, 2030	54° 18' N	130° 25' W	300	XII	EE	active
Canada	CAN	518,0	[H]	XMJ 329	Prescott, ON	0110, 0510, 0910, 1310, 1710, 2110	45° 42' N	125° 32' W	300	IV	EE	active
Canada	CAN	518,0	[H]	XLK835	Tofino, BC	0110, 0510, 0910, 1310, 1710, 2110	48° 56' N	125° 32' W	300	XII	EE	active
Canada	CAN	518,0	[O]	VON	St. Johns, NL	0220, 0620, 1020, 1410, 1810, 2210	47° 37' N	52° 40' W	300	IV	EE	active
Canada	CAN	518,0	[P]	XLJ 895	Thunder Bay, ON	0230, 0630, 1030, 1430, 1830, 2230	48° 26' N	89° 13' W	300	IV	EE	active
Canada	CAN	518,0	[Q]	VCO	Sydney, NS	0240, 0640, 1040, 1440, 1840, 2240	46° 11' N	59° 54' W	300	IV	EE	active
Canada	CAN	518,0	[T]	VFF	Iqaluit, NT	0310, 0710, 1110, 1510, 1910, 2310	63° 44' N	68° 33' W	150	IV	EE	active
Canada	CAN	518,0	[U]	VAR-3	Fundy, NB	0320, 0720, 1120, 1520, 1920, 2320	45° 14' N	65° 59' W	300	IV	EE	active
Canada	CAN	518,0	[X]	VOK	Labrador, NL	0350, 0750, 1150, 1550, 1950, 2350	53° 18' N	60° 33' W	300	IV	EE	active
Canary Isles	CNR	518,0	[I]	EAL	Las Palmas	0120, 0520, 0920, 1320, 1720, 2120	28° 09' N	15° 25' W	400	II	EE	active
Cape Verde	CPV	518,0	[U]	D4A	Sao Vicente	0320, 0720, 1120, 1520, 1920, 2320	16° 51' N	25° 00' W	250	II	EE	active
Chile	CHL	518,0	[I]	CBV	Valparaíso	0010, 0810, 1610	32° 48' S	71° 29' W	300	XV	SS	active
Chile	CHL	518,0	[A]	CBA	Antofgasta	0400, 1200, 2000	23° 40' S	70° 25' W	300	XV	EE	active
Chile	CHL	518,0	[B]	CBV	Valparaiso	0410, 1210, 2010	32° 48' S	71° 29' W	300	XV	EE	active
Chile	CHL	518,0	[C]	CBT	Talcahuano	0420, 1220, 2020	36° 42' S	73° 06' W	300	XV	EE	active
Chile	CHL	518,0	[D]	CBP	Puerto Montt	0430, 1230, 2030	41° 29' S	72° 57' W	300	XV	EE	active
Chile	CHL	518,0	[E]	CBM	Magallenes	0440, 1240, 2040	52° 56' S	70° 54' W	300	XV	EE	active
Chile	CHL	518,0	[H]	CBA	Antofgasta	0000, 0800, 1600	23° 40' S	70° 25' W	300	XV	SS	active
Chile	CHL	518,0	[J]	CBT	Talcahuano	0020, 0820, 1620	36° 42' S	73° 06' W	300	XV	SS	active
Chile	CHL	518,0	[K]	CBP	Puerto Montt	0030, 0830, 1630	41° 29' S	72° 57' W	300	XV	EE	active
Chile	CHL	518,0	[L]	CBM	Magallenes	0040, 0840, 1640	52° 56' S	70° 54' W	300	XV	SS	active
China	CHN	518,0	[L]	VRX	Hong Kong	0150, 0550, 0950, 1350, 1750, 2150	22° 13' N	114° 15' E	250	XI	EE	active
China	CHN	518,0	[M]	XSI	Sanya	0200, 0600, 1000, 1400, 2200	18° 14' N	109° 30' E	250	XI	EE/CC	active
China	CHN	518,0	[N]	XSQ	Guangzhou	0210, 0610, 1010, 1410, 2210	23° 09' N	113° 29' E	250	XI	EE/CC	active
China	CHN	518,0	[O]	XSL	Foochow	0220, 0620, 1020, 1420, 1820, 2220	26° 02' N	119° 18' E	250	XI	EE	active
China	CHN	518,0	[Q]	XSG	Shanghai	0240, 0640, 1040, 1440, 1840, 2240	31° 07' N	121° 33' E	250	XI	EE	active
China	CHN	518,0	[R]	XSZ	Dalian	0250, 0650, 1050, 1450, 1850, 2250	38° 52' N	121° 31' E	250	XI	EE	active
Croatia	HRV	518,0	[Q]	9AS	Split	0240, 0640, 1040, 1440, 1840, 2240	43° 30' N	16° 29' E	150	III	EE	active
Cyprus	CYP	518,0	[M]	5BA	Cyprus	0200, 0600, 1000, 1400, 1800, 2200	35° 02' N	33° 17' E	220	III	EE	active
Easter Island	PAQ	518,0	[G]	CBY	Isla de Pascua	0050, 0850, 1650	27° 09' S	109° 23' W	300	XV	SS	active
Easter Island	PAQ	518,0	[F]	CBY	Isla de Easter	0450, 1250, 2050	27° 09' S	109° 23' W	300	XV	EE	active

Country:	COU:	KHz:	Slot:	Call:	Station Name:	Transmission Times - All in UTC:	Latitude:	Longitude:	Range nm:	Area:	Lang:	Status:
Egypt	EGY	518,0	[N]	SUH	Alexandria	0210, 0610, 1010, 1410, 1810, 2210	31° 12' N	29° 52' E	350	III	EE	active
Egypt	EGY	518,0	[V]	SUK	Kosseir	0330, 0730, 1130, 1530, 1930, 2330	26° 06' N	34° 17' E	350	IX	EE	active
Egypt	EGY	518,0	[X]	SUZ	Serapeum (Ismailia)	0350, 0750, 1150, 1550, 1950, 2350	30° 35' N	32° 17' E	400	IX	EE	active
England	ENG	518,0	[E]	GNI	Niton	0040, 0440, 0840, 1240, 1640, 2040	50° 35' N	01° 18' W	270	I	EE	active
England	ENG	518,0	[G]	GCC	Cullercoats	0100, 0500, 0900, 1300, 1700, 2100	55° 04' N	01° 28' W	270	I	EE	active
England	ENG	518,0	[K]	GNI	Niton (Northern France)	0140, 0540, 0940, 1340, 1740, 2140	50° 35' N	01° 18' W	270	I	EE	active
Equador	EQA	518,0	[L]		Ayora	0150, 0550, 0950, 1350, 1750, 2150	00° 45' S	90° 19' W	250-400	XII	EE	active
Equador	EQA	518,0	[M]	HCG	Guayaquil	0200, 0600, 1000, 1400, 1800, 2200	02° 17' S	72° 01' W		XII	EE	active
Estonia	EST	518,0	[U]	ESA	Tallinn	0320, 0720, 1120, 1520, 1920, 2320	59° 30' N	24° 30' E	300	I	EE	active
Faroes	FRO	518,0	[D]	OXJ	Tórshavn	0030, 0430, 0830, 1230, 1630, 2030	62° 00' N	06° 47' W		I	EE	testing
France	FRA	518,0	[A]	FRC	CROSS Corsen	0000, 0400, 0800, 1200, 1600, 2000	48° 24' N	05° 03' W	300	II	EE	active
France	FRA	518,0	[W]	FRL	CROSS La Garde	0340, 0740, 1140, 1540, 1940, 2340	43° 06' N	05° 59' E	250	III	EE	active
Germany	DEU	518,0	[L]	DEU	Germany	0150, 0550, 0950, 1350, 1750, 2150	53° 43' N	09° 55' E		I	EE	active
Greece	GRC	518,0	[H]	SVH	Irákleio (Crete)	0110, 0510, 0910, 1310, 1710, 2110	35° 20' N	25° 07' E	280	III	EE/GK	active
Greece	GRC	518,0	[K]	SVK	Kerkyra	0140, 0540, 0940, 1340, 1740, 2140	39° 45' N	19° 52' E	280	III	EE/GK	active
Greece	GRC	518,0	[L]	SVL	Limnos	0150, 0550, 0950, 1350, 1750, 2150	39° 52' N	25° 04' E	280	III	EE/GK	active
Greenland	GRL	518,0	[W]	OXI	Nuuk (Kook Island)	0340, 0740, 1140, 1540, 1940, 2340	64° 04' N	52° 02' W	400	IV	EE	active
Guam	GUM	518,0	[V]	NRV	Guam	0100, 0500, 0900, 1300, 1700, 2100	13° 29' N	144° 50' E	100	XI	EE	active
Hawaii	HWA	518,0	[O]	NMO	Honolulu	0040, 0440, 0840, 1240, 1640, 2040	21° 22' N	158° 09' W	350	XII	EE	active
Iceland	ISL	518,0	[R]	TFA	Reykjavik	0250, 0650, 1050, 1450, 1850, 2250	64° 05' N	21° 51' W	550	I	EE	active
Iceland	ISL	518,0	[X]	TFA	Reykjavik	0350, 0750, 1150, 1550, 1950, 2350	64° 05' N	21° 51' W	250	I	EE	active
India	IND	518,0	[G]	VWB	Bombay	0100, 0500, 0900, 1300, 1700, 2100	19° 05' N	72° 50' E	250	VIII	EE	active
India	IND	518,0	[P]	VWM	Madras	0230, 0630, 1030, 1430, 1830, 2230	13° 05' N	80° 17' E	250	VIII	EE	active
Indonesia	INS	518,0	[A]	PNK	Jayapura	0000, 0400, 0800, 1200, 1600, 2000	02° 31' S	140° 43' E	300	XI	EE	active
Indonesia	INS	518,0	[B]	PKE	Ambon	0010, 0410, 0810, 1210, 1610, 2010	03° 42' S	128° 12' E	300	XI	EE	active
Indonesia	INS	518,0	[D]	PKF	Makassar	0030, 0430, 0830, 1230, 1630, 2030	05° 06' S	119° 26' W	300	XI	EE	active
Indonesia	INS	518,0	[E]	PKX	Jakarta	0040, 0440, 0840, 1240, 1640, 1840	06° 07' S	106° 52' E	300	XI	EE	active
Iran	IRN	518,0	[A]	EQM	Bushehr	0000, 0400, 0800, 1200, 1600, 2000	28° 58' N	50° 50' E	300	IX	EE	active
Iran	IRN	518,0	[F]	EQI	Bandar Abbas	0050, 0450, 0850, 1250, 1650, 2050	27° 08' N	57° 04' E	300	IX	EE	active

Country:	COU:	KHz:	Slot:	Call:	Station Name:	Transmission Times - All in UTC:	Latitude:	Longitude:	Range nm:	Area:	Lang:	Status:
Ireland	IRL	518,0	[Q]	EJM	Malin Head Coastguard	0240, 0640, 1040, 1440, 1840, 2240	55° 22' N	07° 21' W	400	I	EE	active
Ireland	IRL	518,0	[W]	EJK	Valentia Coastguard	0340, 0740, 1140, 1540, 1940, 2340	51° 27' N	09° 49' W	400	I	EE	active
Israel	ISR	518,0	[P]	4XO	Haifa	0020, 0420, 0820, 1220, 1620, 2020	32° 49' N	35° 00' E	200	III	EE	active
Italy	ITA	518,0	[R]	IAR	Roma	0250, 0650, 1050, 1450, 1850, 2250	41° 48' N	12° 31' E	320	III	EE/II	active
Italy	ITA	518,0	[U]	IQX	Trieste	0320, 0720, 1120, 1520, 1920, 2320	45° 41' N	13° 46' E	320	III	EE/II	active
Japan	JPN	518,0	[G]	JNB	Naha	0100, 0500, 0900, 1300, 1700, 2100	26° 09' N	127° 46' E	400	XI	EE	active
Japan	JPN	518,0	[H]	JNR	Moji	0110, 0510, 0910, 1310, 1710, 2110	33° 52' N	130° 36' E	400	XI	EE	active
Japan	JPN	518,0	[I]	JGC	Yokohama	0120, 0520, 0920, 1320, 1720, 2120	35° 22' N	118° 43' E	400	XI	EE	active
Japan	JPN	518,0	[J]	JNL	Otaru	0130, 0530, 0930, 1330, 1730, 2130	43° 12' N	141° 00' E	400	XI	EE	active
Japan	JPN	518,0	[K]	JNX	Kushiro	0140, 0540, 0940, 1340, 1740, 2140	42° 59' N	144° 23' E	400	XI	EE	active
Malaysia	MLA	518,0	[S]	9WH 21	Sandakan	0300, 0700, 1000, 1500, 1900, 2300	05° 54' N	118° 00' E	350	XI	EE	active
Malaysia	MLA	518,0	[T]	9WW	Miri	0310, 0710, 1110, 1510, 1910, 2310	04° 28' N	114° 01' E	350	XI	EE	active
Malaysia	MLA	518,0	[U]	9MG	Penang	0320, 0720, 1120, 1520, 1920, 2320	05° 25' N	100° 24' E	350	XI	EE	active
Malta	MLT	518,0	[O]	9HD	Malta	0220, 0620, 1020, 1420, 1820, 2220	35° 49' N	14° 32' E	400	III	EE	active
Mauritius	MAU	518,0	[C]	MAU	Mauritius	0020, 0420, 0820, 1220, 1620, 2020	20° 10' S	57° 28' E	400	VIII	EE	active
Morocco	MRC	518,0	[M]	CNP	Casablanca	0200, 0600, 1000, 1400, 1800, 2200	33° 36' N	07° 38' W	180	II	EE	active
Namibia	NMB	518,0	[B]	V5W	Walvis Bay	0010, 0410, 0810, 1210, 1610, 2010	23° 03' S	14° 37' E	380	VII	EE	active
Netherland	ATN	518,0	[H]	JPC	Curacao	0110, 0510, 0910, 1310, 1710, 2110	12° 10' N	68° 52' W	250	IV	EE	active
Netherlands	HOL	518,0	[P]	PBK	Netherlands Coast Guard	0230, 0630, 1030, 1430, 1830, 2230	52° 06' N	04° 15' E	250	I	EE	active
Norway	NOR	518,0	[B]	LGP	Bodø	0010, 0410, 0810, 1210, 1610, 2010	67° 16' N	14° 23' E	450	I	EE	active
Norway	NOR	518,0	[L]	LGQ	Rogaland	0150, 0550, 0950, 1350, 1750, 2150	58° 39' N	05° 36' E	450	I	EE	active
Norway	NOR	518,0	[N]	LGD	Orlandet	0210, 0610, 1010, 1410, 1810, 2210	63° 40' N	09° 33' E	450	I	EE	active
Norway	NOR	518,0	[V]	LGV	Vardø	0330, 0730, 1130, 1530, 1930, 2330	70° 22' N	31° 06' E	450	n/a	EE	active
Oman	OMA	518,0	[M]	A4M	Muscat	0200, 0600, 1000, 1400, 1800, 2200	23° 37' N	58° 31' E	270	IX	EE	active
Pakistan	PAK	518,0	[P]	ASK	Karachi	0230, 0630, 1030, 1430, 1830, 2230	24° 51' N	67° 03' E	200	IX	EE	active

Country:	COU:	kHz:	Slot:	Call:	Station Name:	Transmission Times - All in UTC:	Latitude:	Longitude:	Range nm:	Area:	Lang:	Status:
Peru	PRU	518,0	[S]	OBY2	Paita	0300, 0700, 1100, 1500, 1900, 2300	05° 05' S	81° 07' W	400	XVI	EE/SS	active
Peru	PRU	518,0	[U]	OBC3	Callao	0320, 0720, 1120, 1520, 1920, 2320	12° 3' S	77° 09' W	400	XVI	EE/SS	active
Peru	PRU	518,0	[W]	OBF4	Matarani	0340, 0740, 1140, 1540, 1940, 2340	17° 01' S	72° 01' W	400	XVI	EE/SS	active
Philippines	PHL	518,0	[I]		Puerto Princesa	0120, 0520, 0920, 1320, 1720, 2120	09° 44' N	121° 03' E	320	XI	EE	active
Philippines	PHL	518,0	[J]	DZS	Manila	0140, 0540, 0940, 1340, 1740, 2140	14° 35' N	121° 03' E	320	XI	EE	active
Philippines	PHL	518,0	[K]		Davao	0140, 0540, 0940, 1340, 1740, 2140	07° 04' N	125° 36' E	320	XI	EE	active
Portugal	POR	518,0	[R]	CTV-	Monsanto	0250, 0650, 1050, 1450, 1850, 2250	38° 44' N	09° 11' W	530	II	EE	active
Puerto Rico	PTR	518,0	[R]	NMR	Isabella - San Juan, PR	0200, 0600, 1000, 1400, 1800, 2200	18° 28' N	67° 04' W	200	IV	EE	active
Russia	RSE	518,0	[A]	UIK	Vladivostok	0000, 0400, 0800, 1200, 1600, 2000	43° 23' N	131° 54' E	280	XIII	EE	active
Russia	RSE	518,0	[C]	UBA2	Petropavlovsk	0020, 0420, 0820, 1220, 1620, 2020	53° 15' N	158° 25' E	280	XIII	EE	active
Russia	RSE	518,0	[D]	UIB	Magadan	0030, 0430, 0830, 1230, 1630, 2030	59° 41' N	150° 09' E	120	XIII	EE	on trial
Russia	RSE	518,0	[G]		Okhotsk	0100, 0500, 0900, 1300, 1700, 2100	59° 22' N	143° 12' E	300	XIII	EE	active
Russia	RUS	518,0	[A]	UDN	Novorossiysk	0300, 0700, 1100, 1500, 1900, 2300	44° 43' N	37° 47' E	300	III	EE	active
Russia	RSE	518,0	[B]	UFO	Kholmok	0010, 0410, 0810, 1210, 1610, 2010	47° 02' N	142° 03' E	300	XIII	EE	active
Russia	RUS	518,0	[C]	UHS	Murmansk	0020, 0420, 0820, 1220, 1620, 2020	68° 46' N	32° 58' E	140	n/a	EE	active
Russia	RUS	518,0	[F]	UGE	Arkhangelsk	0050, 0450, 0850, 1250, 1650, 2050	64° 33' N	40° 32' E	280	n/a	EE	active
Russia (Caspian)	RUS	518,0	[W]	UJB	Astrakhan	0340, 0740, 1140, 1540, 1940, 2340	46° 18' N	47° 58' E	250	III	EE	active
Sardinia	SAR	518,0	[T]	IDC	Cagliari	0310, 0710, 1110, 1510, 1910, 2310	39° 14' N	09° 14' E	320	III	EE/II	active
Saudi Arabia	ARS	518,0	[H]	HZH	Jeddah	0705, 1305, 1905	21° 23' N	39° 11' E	390	IX	EE	active
Scotland	SCT	518,0	[O]	GPK	Portpatrick	0220, 0620, 1020, 1420, 1820, 2220	54° 51' N	05° 07' W	270	I	EE	active
Sicily	SCY	518,0	[V]	IQA	Augusta	0330, 0730, 1130, 1530, 1930, 2330	37° 14' N	15° 14' E	320	III	EE/II	active
Singapore	SNG	518,0	[C]	9VG	Singapore	0020, 0420, 0820, 1220, 1620, 2020	01° 20' N	103° 42' E	400	XI	EE	active
South Africa	AFS	518,0	[C]	ZSC	Cape Town	0020, 0420, 0820, 1220, 1620, 2020	33° 41' S	18° 43' E	500	VII	EE	active
South Africa	AFS	518,0	[I]	ZSQ	Port Elizabeth	0120, 0520, 0920, 1320, 1720, 2120	33° 57' S	25° 31' E	500	VII	EE	active
South Africa	AFS	518,0	[O]	ZSD	Durban	0220, 0620, 1020, 1420, 1820, 2220	29° 48' S	30° 49' E	250	VII	EE	active
South Korea	KOR	518,0	[V]		Chukpyon	0330, 0730, 1130, 1530, 1930, 2330	37° 03' N	129° 26' E	200	XI	EE	active
South Korea	KOR	518,0	[W]		Pyonsan	0340, 0740, 1140, 1540, 1940, 2340	35° 36' N	126° 29' E	200	XI	EE	active

Country:	COU:	kHz:	Slot:	Call:	Station Name:	Transmission Times - All in UTC:	Latitude:	Longitude:	Range nm:	Area:	Lang:	Status:
Spain	ESP	518,0	[D]	EAR	Coruna	0030, 0430, 0830, 1230, 1630, 2030	43° 21' N	08° 27' W	400	II	EE	active
Spain	ESP	518,0	[G]	EAC	Tarifa	0100, 0500, 0900, 1300, 1700, 2100	36° 01' N	05° 35' W	400	II	EE	active
Spain	ESP	518,0	[X]	EAV	Valencia (Cabo de la Nao)	0350, 0750, 1150, 1550, 1950, 2350	38° 43' N	00° 09' W	300	III	EE	active
Svalbard	SVB	518,0	[A]	LGS	Svalbard	0000, 0400, 0800, 1200, 1600, 2000	78° 04' N	13° 36' E	450	n/a	EE	active
Sweden	SWE	518,0	[H]	SAH	Bjuröklubb	0110, 0510, 0910, 1310, 1710, 2110	64° 28' N	21° 36' E	300	I	EE	active
Sweden	SWE	518,0	[I]	SAG	Grimeton	0120, 0520, 0920, 1320, 1720, 2120	57° 06' N	12° 23' E	300	I	EE	active
Sweden	SWE	518,0	[J]	SAA	Gisövshammar	0130, 0530, 0930, 1330, 1730, 2130	55° 29' N	14° 19' E	300	I	EE	active
Taiwan	TWN	518,0	[P]		Lintou	0230, 1030, 1830	23° 33' N	119° 38' E	350	XI	EE	active
Taiwan	TWN	518,0	[P]		Yenliaken	0630, 1430, 2230	23° 54' N	121° 36' E	350	XI	EE	active
Thailand	THA	518,0	[F]	HAS	Bangkok (Nonthaburi)	0050, 0450, 0850, 1250	13° 01' N	100° 01' E	200	XI	EE	active
Turkey	TUR	518,0	[D]	TAH	Istanbul	0030, 0430, 0830, 1230, 1630, 2030	41° 04' N	28° 57' E	300	III	EE	active
Turkey	TUR	518,0	[E]	TAF	Samsun	0040, 0440, 0840, 1240, 1640, 2040	41° 17' N	36° 20' E	300	III	EE	active
Turkey	TUR	518,0	[F]	TAL	Antalya	0050, 0450, 0850, 1250, 1650, 2050	36° 35' N	30° 42' E	300	III	EE	active
Turkey	TUR	518,0	[I]	TAN	Izmir	0120, 0520, 0920, 1320, 1720, 2120	38° 21' N	26° 35' E	300	III	EE	active
Ukraine	UKR	518,0	[B]	UTW	Kerch	0100, 0500, 0900, 1300, 1700, 2100	44° 23' N	36° 28' E	280	III	EE	active
Ukraine	UKR	518,0	[C]	UTT	Odessa	0230, 0630, 1030, 1430, 1830, 2230	46° 29' N	30° 44' E	280	III	EE	active
United States	USA	518,0	[A]	NMA	Miami, FL	0000, 0400, 0800, 1200, 1600, 2000	25° 30' N	80° 23' W	240	IV	EE	active
United States	USA	518,0	[C]	NMC	San Francisco (Point	0000, 0400, 0800, 1200, 1600, 2000	37° 55' N	122° 42' W	350	XII	EE	active
United States	USA	518,0	[E]	NMB	Savannah, GA	0040, 0440, 0840, 1240, 1640, 2040	32° 08' N	81° 42' W	200	IV	EE	active
United States	USA	518,0	[F]	NMF	Boston, MA	0045, 0445, 0845, 1245, 1645, 2045	41° 43' N	70° 31' W	200	IV	EE	active
United States	USA	518,0	[G]	NMG	New Orleans, LA	0300, 0700, 1100, 1500, 1900, 2300	29° 53' N	89° 55' W	200	IV	EE	active
United States	USA	518,0	[N]	NMN	Portsmouth, VA	0130, 0530, 0930, 1330, 1730, 2130	36° 44' N	76° 01' W	280	IV	EE	active
United States	USA	518,0	[Q]	NMQ	Long Beach, CA (Cambria)	0045, 0445, 0845, 1245, 1645, 2045	35° 31' N	121° 03' W	350	XII	EE	active
United States	USA	518,0	[W]	NMW	Astoria, OR	0130, 0530, 0930, 1330, 1730, 2130	46° 10' N	123° 49' W	216	XII	EE	active
Uruguay	URG	518,0	[F]	CWM27	La Paloma	0050, 0450, 0950, 1350, 1750, 2150	34° 40' S	54° 09' W	280	VI	EE	active
Vietnam	VTN	518,0	[K]	XVT	Danang	0140, 0540, 0940, 1340, 1740, 2140	16° 05' N	108° 13' E	400	XI	EE	active
Vietnam	VTN	518,0	[W]	XVG	Haiphong	0230, 0630, 1030, 1430, 1830, 2230	20° 44' N	106° 44' E	400	XI	EE	active
Vietnam	VTN	518,0	[X]	XVS	Ho Chi Minh-Ville	0350, 0750, 1150, 1550, 1950, 2350	10° 47' N	106° 40' E	400	XI	EE	active

4209.5 kHz:

Country:	COU:	kHz:	Slot:	Call:	Station Name:	Transmission Times - All in UTC:	Latitude:	Longitude:	nm:	Range Area:	Lang:	Status:
Egypt	EGY	4209,5	[X]	SUZ	Serapeum (Ismalia)	0750, 1150	30° 28' N	32° 22' E		IX		active
Taiwan	TWN	4209,5	[P]		Chi-lung (Keelung)	0230, 1030, 1830	25° 08' N	121° 45' E	540	XI	EE	active
Taiwan	TWN	4209,5	[P]		Linyuan	0630, 1430, 2230	22° 29' N	120° 25' E	540	XI	EE	unknown
Taiwan	TWN	4209,5	[V]	XSX	Chi-lung (Keelung)	0330, 0730, 1130, 1530, 1930, 2330	25° 08' N	121° 45' E	540	XI	CC	active
Taiwan	TWN	4209,5	[X]		Linyuan	0350, 0750, 1150, 1550, 1950, 2350	22° 29' N	120° 25' E	540	XI	CC	active
Turkey	TUR	4209,5	[M]	TAH	Istanbul	0200, 0600, 1000, 1400, 1800, 2200	41° 04' N	28° 57' E	300	III	TT	active
Vietnam	VTN	4209,5	[W]		Haiphong	0340, 0740, 1140, 1540, 1940, 2340	20° 44' N	106° 44' E	400	XI		active

n/a Navarea not assigned (usually polar region)

7. NMEA printer and navigation log

7.1. Printing of NMEA data

The FMD25 can be used as an NMEA printer. In this mode NMEA signals are fed via the NMEA 0183 interface unaltered to the integrated printer.

Please note, that only data strings, which are corresponding to the NMEA 0183 definition, can be processed.

The unit, which is destined to supply NMEA data (GPS, compass, log etc.), should be connected to the NMEA input of the FMD25.

Activating the NMEA print function:

- press button **<SETUP>**
- select menu position **-3- NMEA** and press **<ENTER>**
- select menu position **-1- NMEA PRINT** and press **<ENTER>**

The FMD25 is now operating as an NMEA printer. When data come from the connected device, they will be printed out unaltered. Since NMEA data are transmitted in a one second rhythm, it is advisable not to leave the unit in this mode for a longer period, in order to save paper.

This function of the FMD25 is suitable for checking and documenting NMEA signals.

To leave this mode:

- press button **<EXIT>** three times to return to standby mode.

ATTENTION:

During the function <NMEA PRINT> the FMD25 cannot operate other functions. This means that cannot receive NAVTEX messages nor do the timer functions operate!!



7.2. Activating position log

When connected via NMEA 0183 interface to an external GPS, it is possible with the FMD25 to receive, store and print out the NMEA data record "GPS transit specific \$xxRMC", which is practically a complete record of the route.

The formula for this data record must read as follows:

```
$xxRMC,111111,A,2222.222,N,33333.333,W,44.555.,  
666666,77.,E*CS
```

All variants of this \$xxRMC data record with the different period and commas will be recognised and processed. Other data records other than RMC type will not be recognised!!

The RMC data record has been defined however as the standard data record for GPS equipment, so that all well known models can be easily connected.

The contents of the data record are:

111111	time in hhmmss
A	identity if data valid (A) or invalid (V)
2222.222	latitude in degrees, minutes, 1/1000mins
N	direction - (N) north, (S) south
33333.333	longitude in degrees, minutes, 1/1000mns
W	direction - (W) west, (E) east
44.44	speed over ground (SOG in Kns)
555	heading over ground (degrees)
666666	date as DDMMYY
77	deviation value
E*	check value

This data record will be memorised and stored by the FMD25. The storage can hold 50 data records. When the storage is full, the data will be automatically printed out.

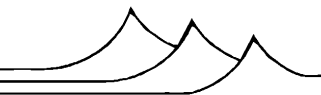

To control the continual amount of data, two parameters can be selected to define the information according to your personal wish.

Parameter 1: time from 1 to 99 minutes

You can select, in which time intervals the position should be stored, even when there has been no movement (e.g. at anchor, in berth).

If **<00>** is entered as time parameter, there will be no time-defined entry. This saves data records being stored and printed out, when the vessel is stationary for a longer period of time.

Parameter 2 positional movement in minutes (1 to 9nm)

You can also select, independent from the time interval, a distance after which the position of your vessel should be documented. For easy calculation, the values north/south and east/west are separated.

To activate the log:

- press **<SET UP>** button
- select menu position **-2- GPS LOG** and press **<ENTER>**
- to activate the log function press **<YES>**
(press **<NO>** to switch off)
- use cursor **<DOWN>** to spring to position **TIME**
- select the **TIME** interval with buttons **<YES>/<NO>**
- use cursor **<DOWN>** to spring to position **WAY**
- select the **WAY** interval with buttons **<YES>/<NO>**
- press button **<EXIT>** 4 times to return to stand-by

The FMD25 navigation log function will work even when other functions e.g. reception, decoding are in process. Only when an incoming NAVTEX message or a longer decoding is taking place, will the position log be interrupted, however it will commence immediately at the end of the message. At any given time, 50 position data will be stored. After every 50th value, the storage will be printed out automatically. This does not take place during message decoding or when the FMD25 is being operated manually, but as soon as the FMD25 returns to the stand-by mode.

However, you can print out the actual stored data at any time. To do this:

- call up the **GPS LOG**
- press **<PRINT>**

When the print out has ended, the display will ask:

<DELETE ALL?>

Press **<YES>** to delete all position data in the storage or press **<NO>** to save the data. On receipt of new data, the oldest will be automatically deleted.

Using the above function, it is manually possible to print out the log daily. An automatic deletion after print out was deliberately waived to make it possible to repeat the print out, should there be a printer error.

8. System set up







8.1. Setting of time and date

- Press button **<SET UP>** to enter the menu

The display will show:

```
1_TIME      5 CHANNELS
2 TIMER     6 VESSEL
3 NMEA      7 STATUS
4 NAVTES    8 EXIT
```

The cursor is already on position 1 - TIME

- Press  to set the TIME
- By using the cursors  and  you can select the hours, minutes etc. Positions
- Using the cursors  and  you can alter the values as required.
- Having checked that all values are correct, press  and return to the **<SET UP>** menu. The selected time has now been stored.

8.2. Setting of owner's and ship's names

The name of the owner and of the ship can be entered into the FMD20. They will then appear on the bottom line at the end of each print out.

- use the cursor **<DOWN>** to spring to position 6 - **VESSEL**
- press **<ENTER>** to call up menu position 1 **OWNER**.



The display will show:

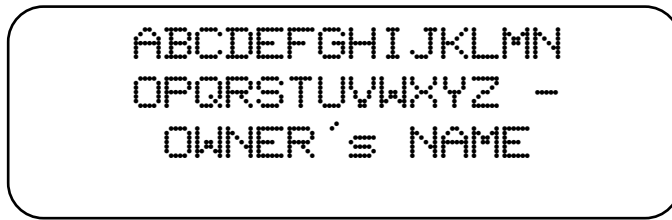

Using the cursors **<YES>** and **<NO>** you can select the letters **A** to **Z**, **(-)**hyphens and **()**spaces. The selected letter is allotted by pressing **<DOWN>**. The letter can be deleted again by pressing **<UP>**. When the owner's name has been correctly selected, press **<ENTER>** to store.

The same procedure should be used for storing the vessel's name.

- Use cursor **<DOWN>** to spring to menu position **2 SHIP**
- Press **<ENTER>** to call up above display.

8.3. Print out of system data

The following system data can be printed out:

- Navigation log ON/OFF and (by ON) trigger parameters
- programmed reception channels and their
 - mode
 - message storage
 - message direct print out
- programmed timer status 1 to max. 9
- unit type and version number
- name of owner and ship if entered

To activate the print out:

- press **<DOWN>** and spring to position **7 - STATUS**
- press **<ENTER>** to commence printing

NAVTEX parameters can be printed out separately under menu position **3 - NAVTEX**.



Data storage:

All stored data, such as system parameters, receiver parameters, timer status, stored messages etc. remain stored for at least 3 months, and under optimal conditions up to 12 months. This is possible because of the integrated NiCd battery, which is continually charged when the unit is in operation.

It is recommended that in a case where the unit should be out of operation for a longer period, that you print out the system data and the NAVTEX parameters and file them. Should there be a loss of data, you can re-enter the old data from the print out.

8.4. Memory deletion and reset

All programmed system parameter data can be deleted i.e. can be reset to the standard parameters. Equally, all stored messages can be deleted. In this case the programmed timer status, navigation log status and NAVTEX parameters will also be deleted. It is therefore recommended, that you print out the system and NAVTEX status, **before** you commence this function (see chapters 8.3. and 5.7.)

To activate the deletion function:

1. Switch off the unit - <OFF>
2. Hold button <NO> and
3. Switch on - <ON>
4. Release button <NO>

The display will show:

```
Clear whole
memory ?

YES / NO
```

5. Answer by pressing <YES> or <NO>
6. Switch the unit off for a few seconds and switch on again.

All data, which is programmable, are deleted and can now be newly programmed. FMD25 to the following address:

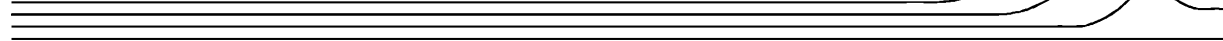

9. Installation

9.1. Packing contents

Please check, that the following contents, necessary for the installation of the FMD 25 are supplied:

- 1 pcs pre-assembled power connection cable
- 2 pcs universal mounting brackets
- 4 pcs self holding spacers
- 4 pcs lock washers M5
- 4 pcs thumb screws M5
- 1 pcs spare fuse 2A slow-blow 5 x 20mm
- 1 pcs fuse, 300mA slow-blow 5 x 20mm
(active antenna)
- 1 pcs mounting hole template
- 1 pcs instruction manual

9.2. Installation of unit

The two universal mounting brackets allow:

- table fitting
- wall fitting

Additionally the FMD25 can be fitted at 4 different angles. Screw the brackets with the 4 screws to the wall or ceiling, using the adhesive template in order to bore the holes in the correct positions.

On each side of the FMD25, there are two M5 threaded holes for fitting at the required angle with the thumb screws. Beforehand, press the self-holding spacers into the selected holes. These keep the brackets at a defined distance from the casing and has been accounted for in the template.

Before boring the holes, we recommend you to attach the brackets, power supply and antenna cables, and select the final mounting position.

Using the template, bore the holes in the exact positions and screw on the brackets. Hold the FMD25 at the selected angle and attach with the thumb screws into the holes with the spacers.

ATTENTION

IMPORTANT INFORMATION

The FMD25 has two M5 threaded holes on either side for the supplied thumb screws, so that it can be fitted to the universal mounting bracket. The length of the thumb screws has been so determined, that, together with the bracket and the lock washers, they can only penetrate approx. 5mm into the thread.

Should you use alternative fitting methods or screws, please make sure that they do not penetrate the thread by more than 5mm.

By using longer screws, the integrated electronic could be damaged !!

Dimensions:

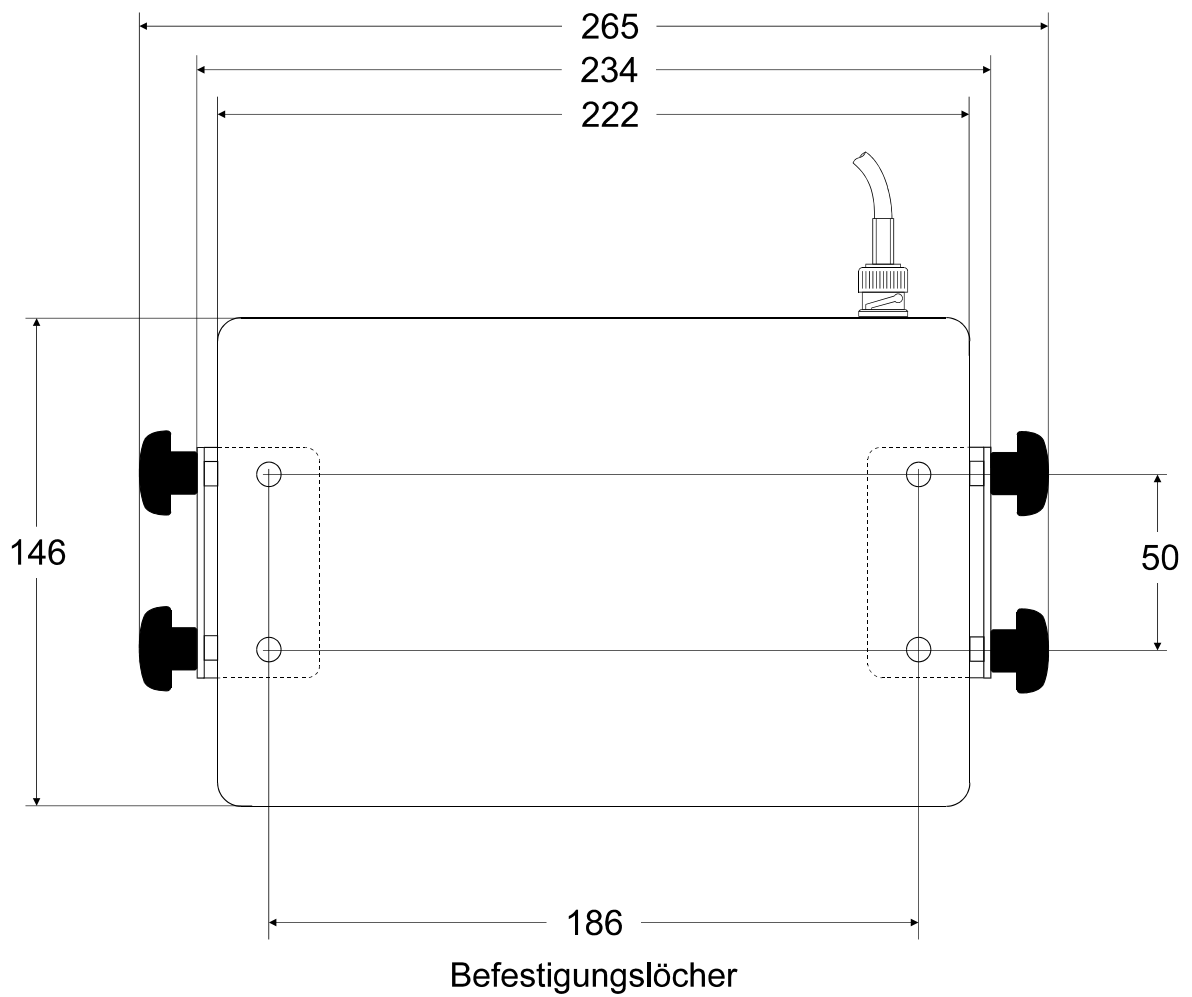
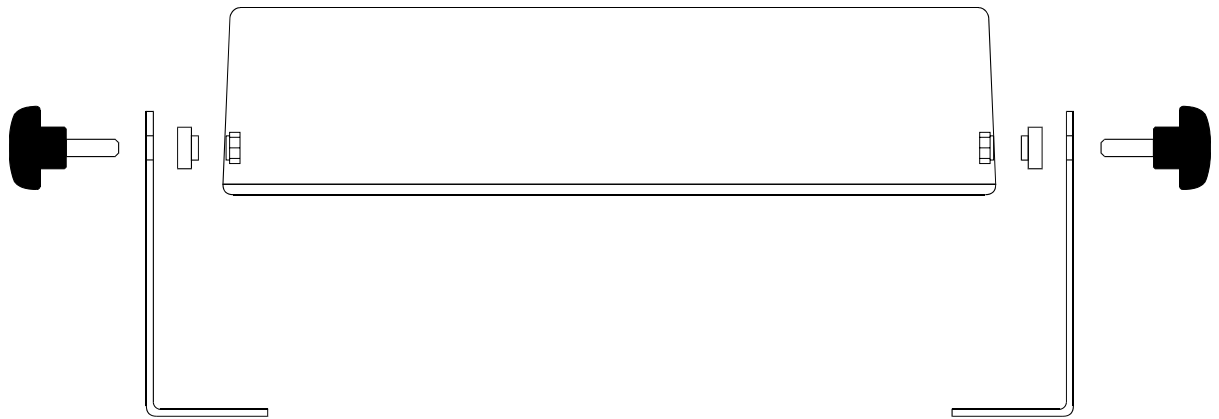

Desktop Installation:

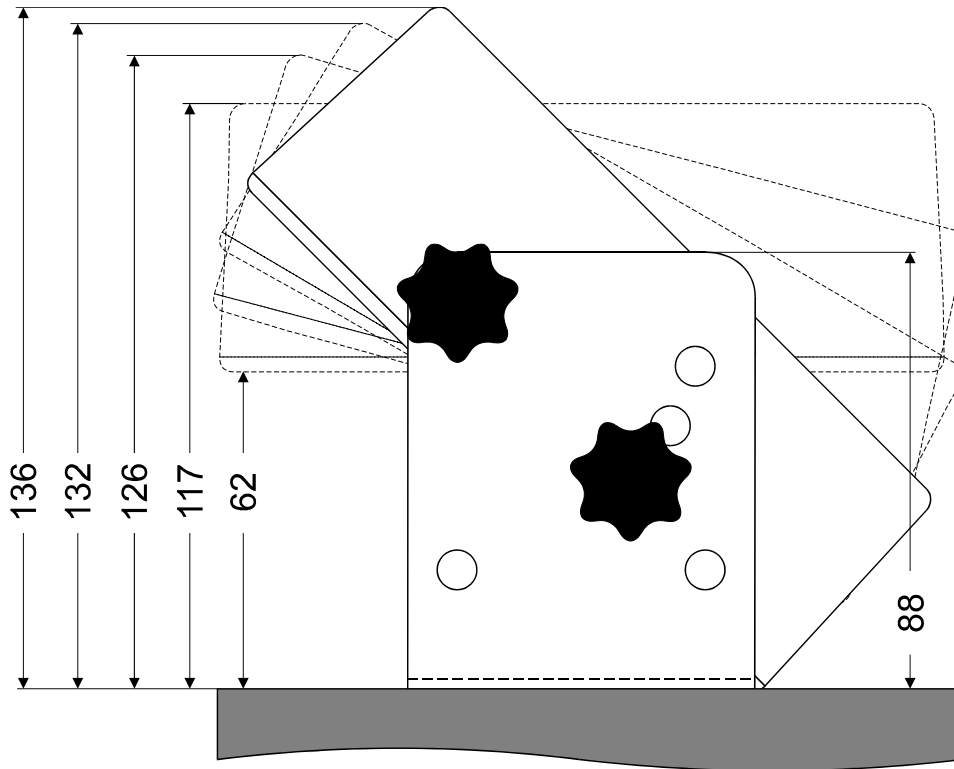

Wall Installation:

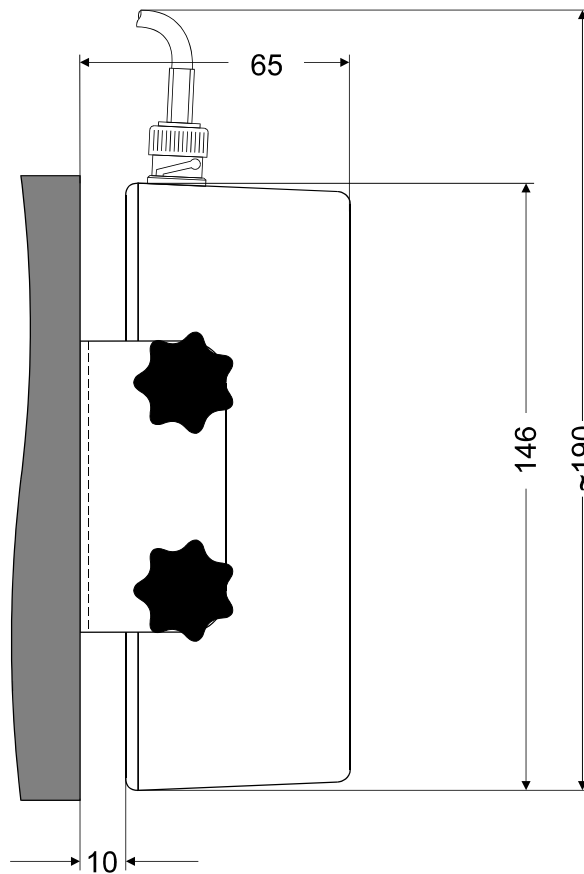

9.3. Power supply connection

Plug the pre-assembled cable supplied into the socket at the rear. The clip on connection is self-locking. To release, the lock clip must be pressed in the direction of the casing with a suitable tool.

The unit was manufactured to operate on a supply voltage of 11V to 15V DC (12V battery). The FMD25 has reverse battery and over voltage protection. Should an incorrect connection take place, check the fuse and if necessary, replace.

The power cable is shielded to suppress disturbances. The open end is ready for connection and is fitted with a terminal strip.

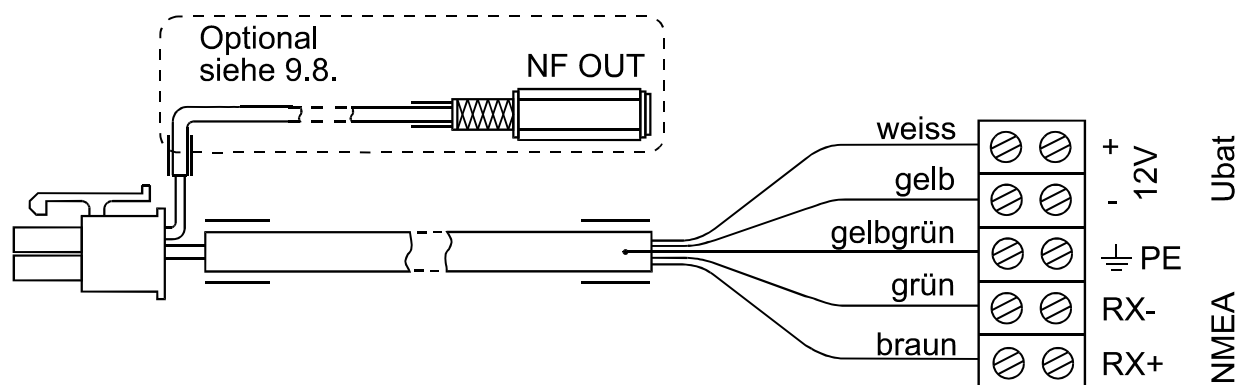

The connection should be as near as possible to the distribution panel or the battery. It is most important, that the current is completely free of interference. Should there be any doubt, we recommend, that you fit a suppression filter.

Before switching on, we recommend you to test the polarity and the voltage at the terminals on the unit.

9.4. NMEA interface connection

Using the FMD25 as navigation log or NMEA printer, the NMEA interface must be connected with an external NMEA device (e.g. GPS) The TX+ / TX- of the external unit must be connected to the RX+ / RX- of the FMD25.

9.5. Antenna and earth connection

The antenna socket is designed to be fitted to a coaxial cable connection with a BNC plug and impedance of 50Ω . No provision has been made for the connection of high impedance, unshielded antennæ.

The reception quality depends, to a high degree, on the quality of the antenna used. A good antenna guarantees good reception.

We recommend the use of a well tuned passive antenna or a high performance active antenna. Cheap active antenna do not provide the desired results due to bad cross-modulation characteristics.

Long wire antenna (e.g. on the back-stay) should be used in connection with an impedance matching balun.

Important for good reception is of course good earthing of the ship's power supply and the FMD25. An adequately dimensioned grounding sponge and properly matched antenna will result in optimum performance.

For installation recommendations, see the following pages:

Installation with Long-Wire-Antenna and Balun

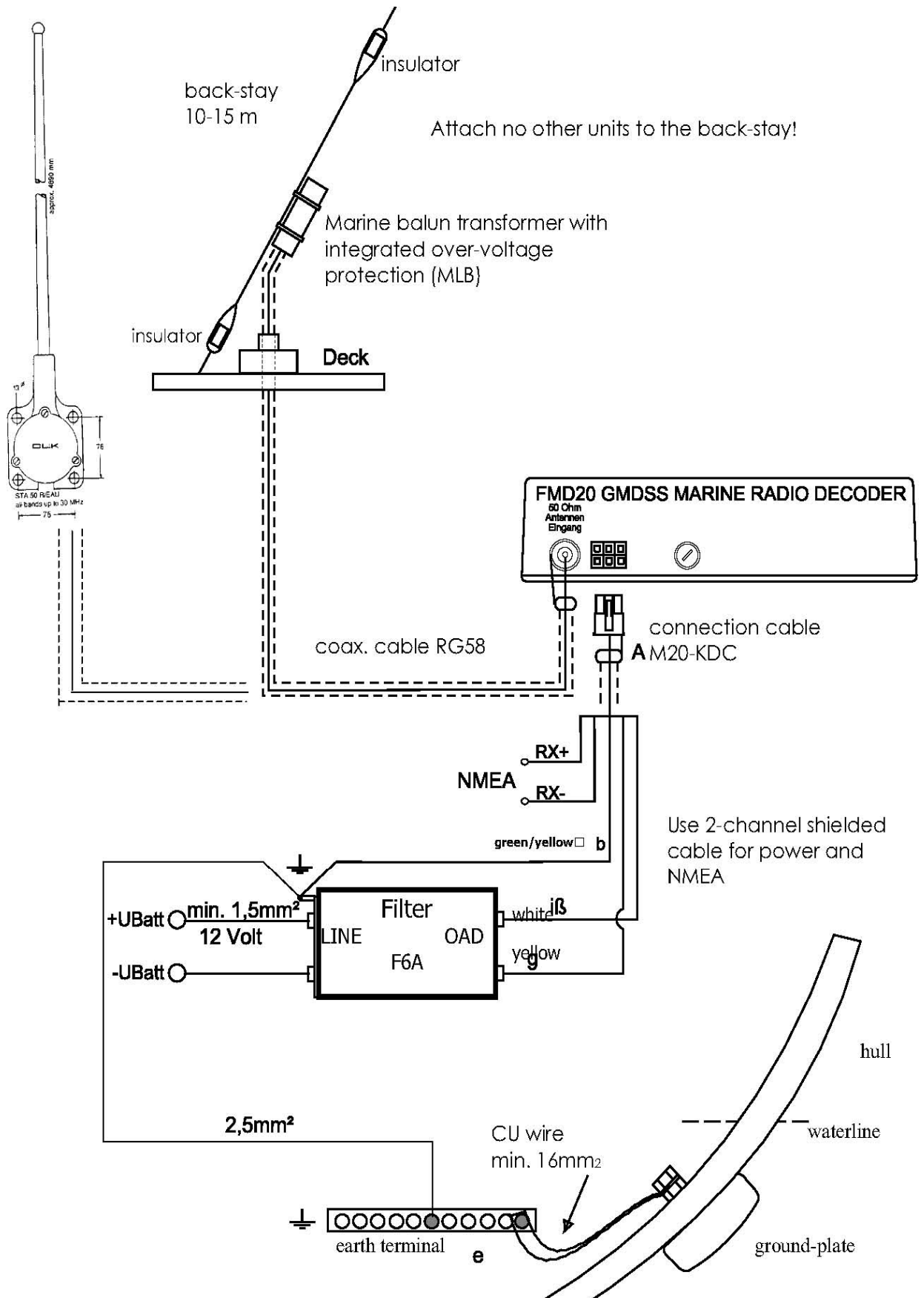

Installation with Active-Antenna

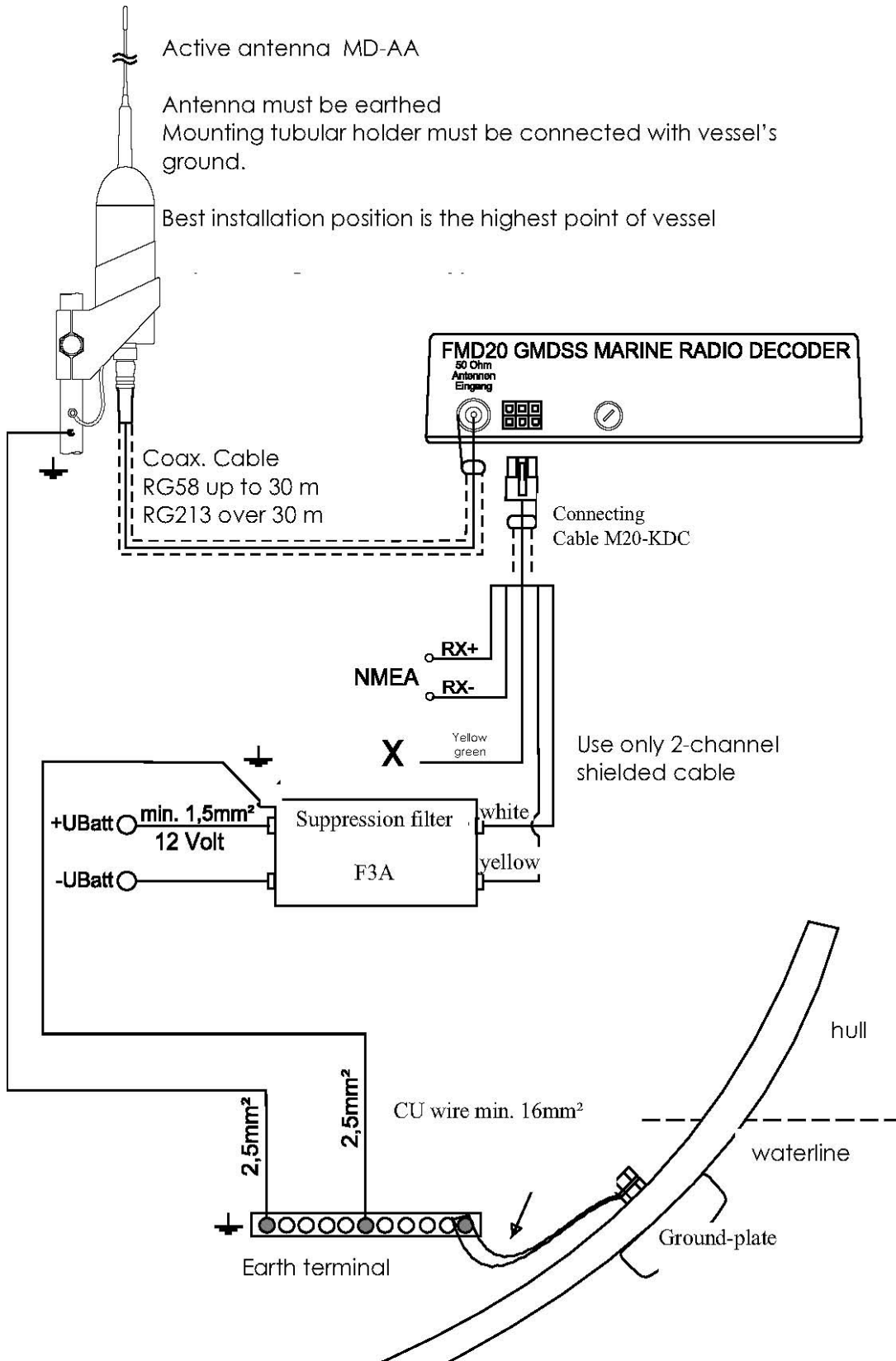

Installation with Active-Antenna R & R

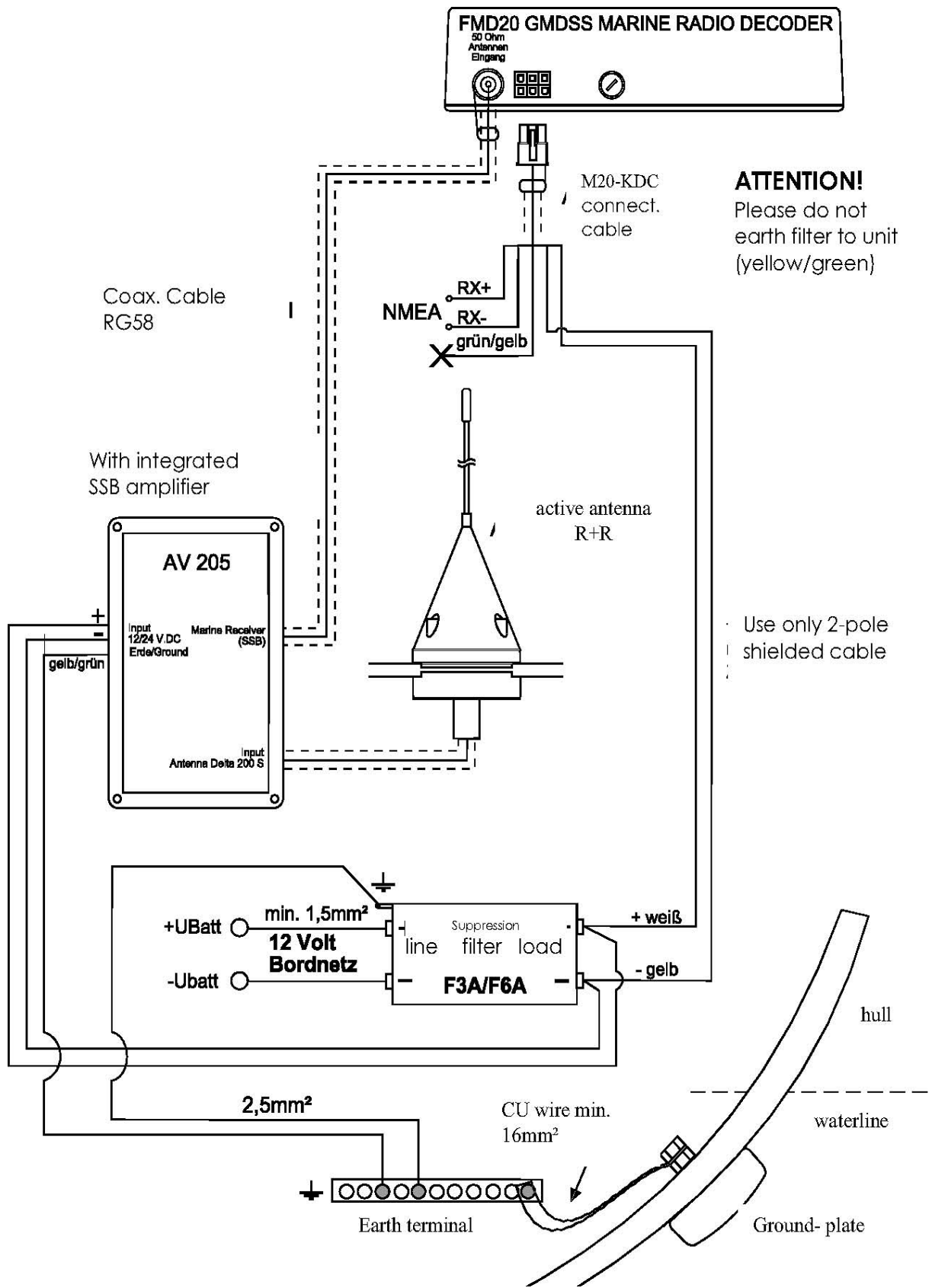



9.6, Printer paper change

The FMD25 has a thermal printer, which uses thermal printer paper with a width of 80mm. The diameter of the paper roll must not exceed 45mm and the diameter of the core, no more than 12mm. The standard supplied roll has an approximate length of 25 metres and prior to reaching the end, a colour indication will appear, reminding you to change the roll.

Changing the roll:

1. remove paper roll lid
2. pull the old roll and core rod upwards to remove, making sure that there are no paper remains are left in the mechanism!
3. Stick the core rod through the new roll and replace in the holder.
- 4 Cut the end of the roll as in sketch

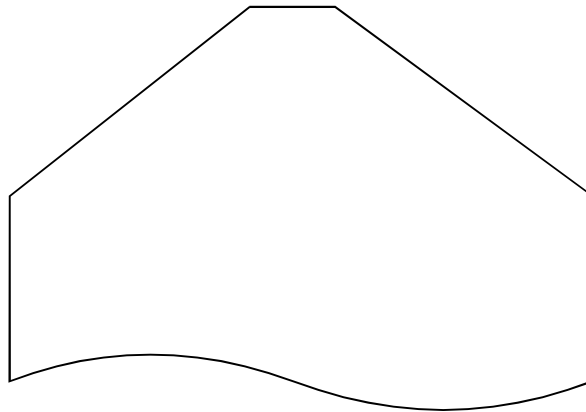

5. Feed the paper through the guide until the paper appears at the tear-off blade.
6. straighten the paper by pulling parallel.
7. replace the lid.
8. print out one of the stored messages to test if the printer is working correctly.

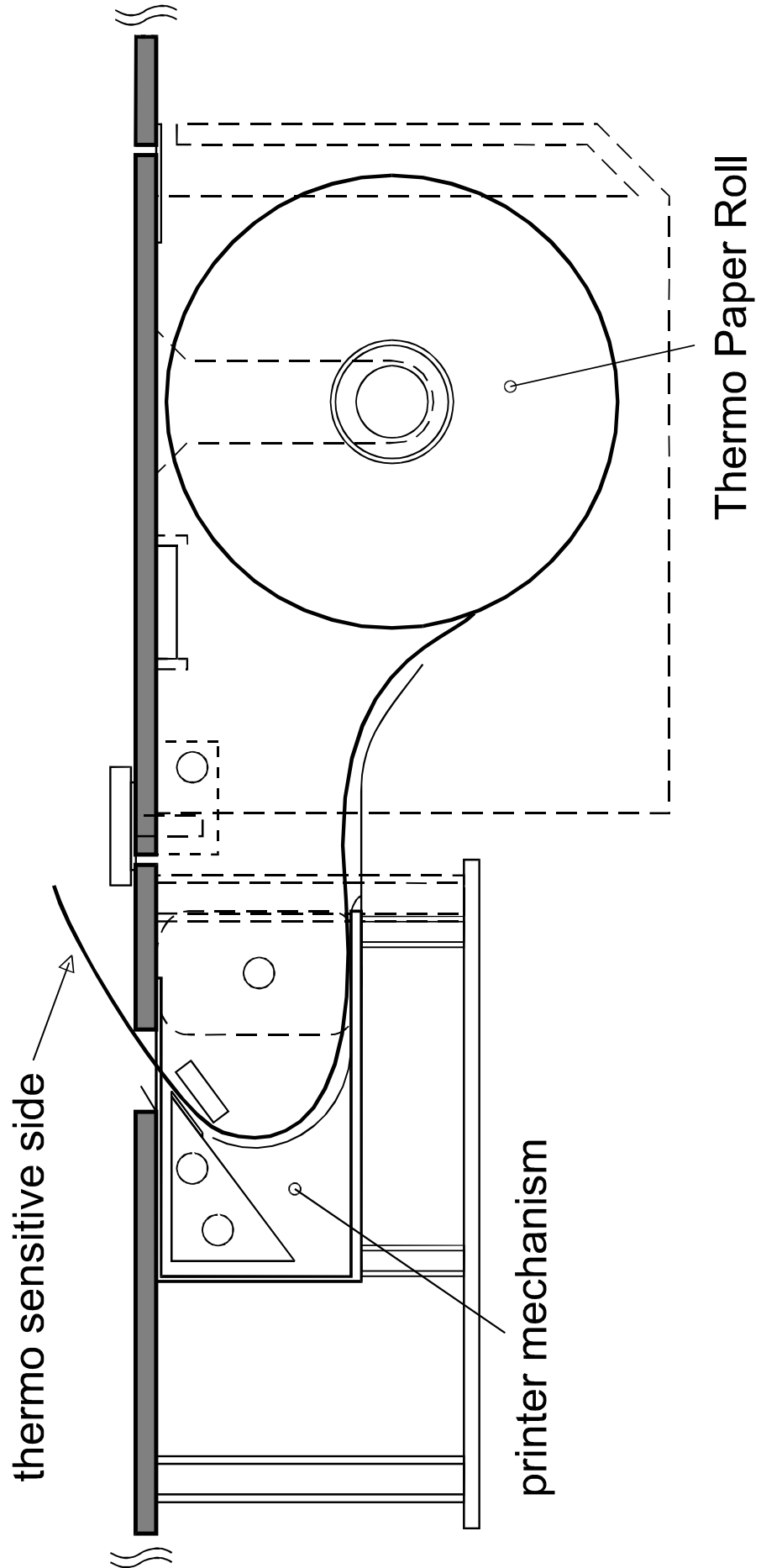



9.7. Active antenna power supply

The FMD25 has an integrated feeder for a power supply of 12V and maximum current consumption of 250mA, for an active antenna, which that any interconnected supply units in the antenna cable are superfluous.

This supply unit is not activated when leaving the factory, because when attaching a balun (impedance matcher), there would be a short circuit burden and other types of antennæ would have a 12V burden on the coupling.

To activate the power supply for the active antenna:

remove the lid of the unit by unscrewing the six screws on the rear of the unit. Put in the 5 x 20mm / 500mA tubular glass fuse which is supplied into the fuse holder next to the main fuse.

ATTENTION: SHOULD IT BE NECESSARY TO CHANGE THIS FUSE AT ANY TIME, NEVER USE STRONGER FUSES, AS THIS COULD LEAD TO DESTRUCTION OF POWERSUPPLY PARTS !!!

9.8. Audio output

The FMD25 does not have a LF amplifier nor integrated speakers. This means one cannot hear or control acoustically. For every day use, this is unnecessary with the FMD25, as the signal strength is displayed. Maximum is twelve arrows but from seven arrows upwards, the signal is strong enough to be decoded. However the strength of the signal can be influenced by strong noise ratio or interfering signals.

Optionally, you can order a shielded cable of about 50cm and a 3.5mm jack, on which there is an LF signal sound of approximately 1 Vpp, which can be made audible over a suitable amplifier and speaker. Fastnet Radio offer a loudspeaker with integrated 12V DC amplifier, which can be connected simply to the 3.5mm jack.

10. FMD25 accessories

10.1. 24V DC/DC converter

The FMD25 can be operated with a DC/DC converter. This offers the following advantages:

- input voltage range 9V to 36V
- constant output voltage 12.5V

This means that the FMD25 can be operated by 12V and 24V batteries. The DC/DC converter has an integrated filter, which suppresses interference from the ship's voltage supply and offers additionally, a galvanic separation between the power supply and the unit. (An advantage for aluminium hulls).

10.2. Converter installation

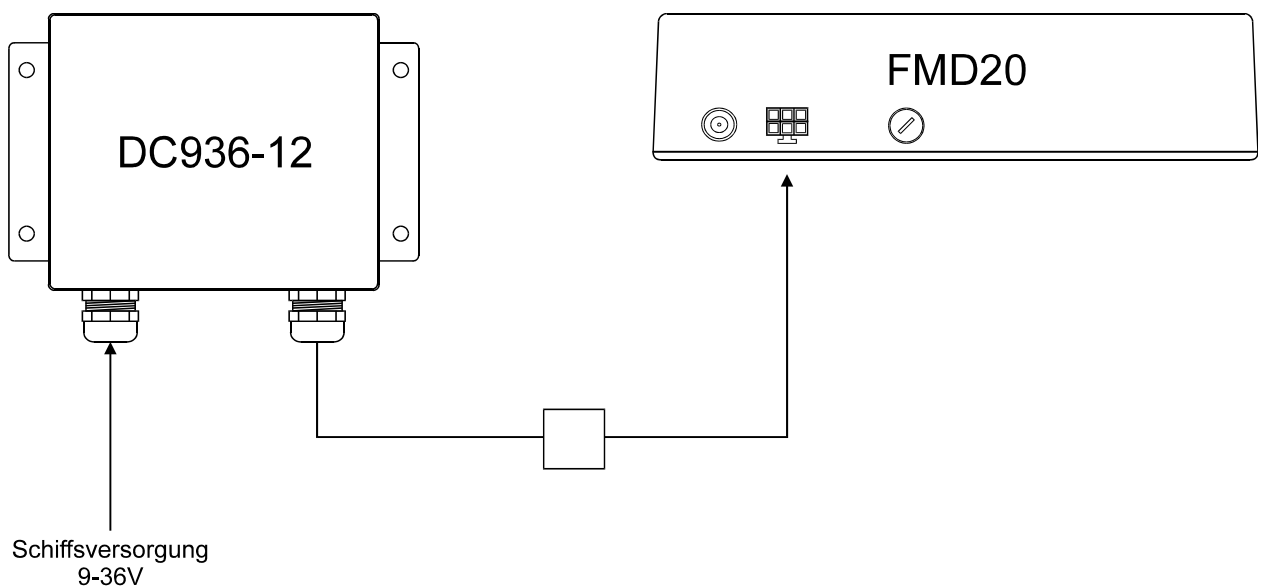

10.3. DC24-12 DC/DC converter from 18V-36V to 12V DC

With the DC/DC converter, DC24-12, it is possible to operate electronic 12V nominal voltage devices with a 24V on board network. The maximum power consumption of the unit connected can be as high as 30 Watt.

By an input voltage from 18V to 36V, the output voltage will be constant. The input and output voltages are galvanically separated. The efficiency is between 85 and 95%, depending on the fluctuation of load. Special filters have been integrated at input and output, to suppress noise voltage and radiation interference and which guarantee interference free operation of connected devices and from the onboard network. We recommend that you use shielded cables for input and output. For this reason, an earth connection has been provided for at both terminals.

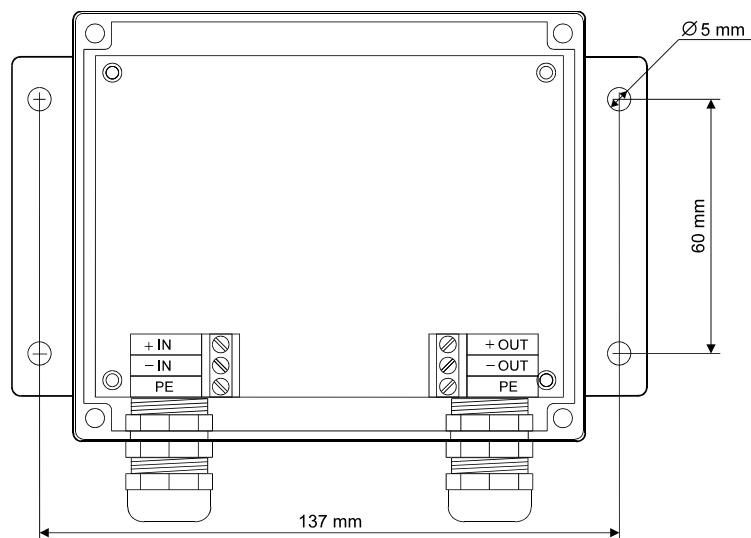

Technical information:

Measurements: 150 x 102 x 36 mm (l x b x h)

Connections: PG11 terminal screws

Input voltage: 18 to 36 Volt DC

Type DC24-12: 12V output voltage

max. output current 2.5A

10.4. MD-AA active antenna for FMD15, 20, 25, 50 and 55

Description :

The MD-AA active antenna has been specially developed and tuned for the Fastnet Radio GMDSS Marine Decoder series FMDxxx, but can also be used for any other receiver in the above reception range. It was mainly designed for the reception of vertically polarised waves in the long, medium and short ranges. Extra value has been placed on a greater spacing interval between the signal and the interference level, rather than reaching a higher output potential. Carefully tuned for this purpose, the antenna electronics adapt themselves to a low noise level, vertical linear impedance transformer, which guarantees the highest possible signal interference immunity. By using the most modern shielded circuits, damage, caused by over-voltage, such as atmospheric or electrostatic lightning, will generally be ruled out. The electronics are installed in a shockproof, UV and oil resistant casing, which optimally protects them against mechanical or atmospheric damage. The robust N-connection in the antenna is weathering resistant. A fitting coaxial cable (RG214/RG58) serves simultaneously to branch off reception signals as well as to supply the distribution voltage. A universally fitting mount for the installation on tubular or plain surfaces is standard supply. The latest versions of FMDs have an integrated antenna -adapted power supply, which can be activated on desire. In this case, only a suitable coaxial cable, connected to the decoder's antenna input, is required, making the additional installation of an antenna power supply unnecessary.

TECHNICAL DATA

Frequency range:	100 kHz to 30 MHz
Impedanz:	50 Ohm
VSWR :	< 2
Connector:	N - Buchse
Power supply:	via HF connector
Voltage:	12 V DC (10 to 16 Volt)
Current consumption:	max. 65 mA at 12 V

Intermodulationsabstand

2. Ordnung $E_1 = E_2 = 0,1V/m$ typ. 75 dB
 3. Ordnung $E_1 = E_2 = 0,1V/m$ typ. 95 dB

Ordering Information :

MD-AA Active Antenna

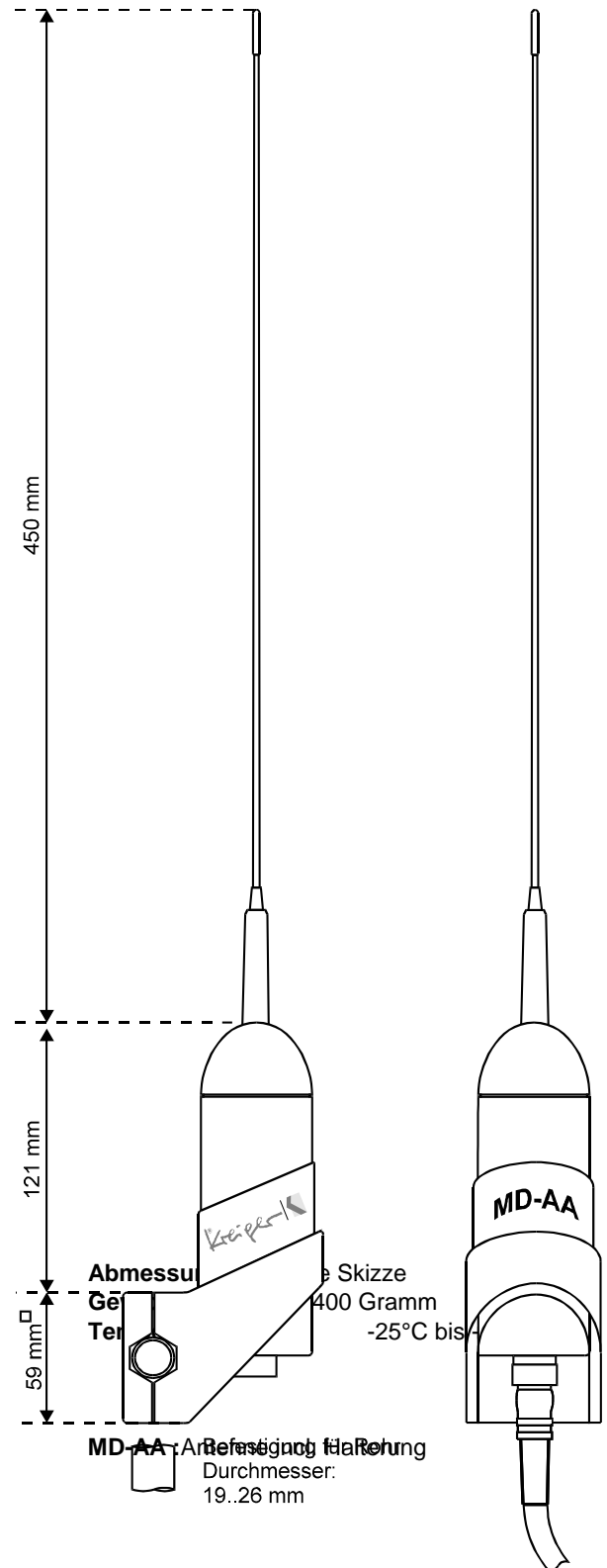

10.5. MLB marine long-wire balun for after stay

The function of the MLB is to match impedance of the high Ohm long-wire stay antenna with the 50Ω antenna input. The balun is connected to the antenna input with a shielded 50Ω coaxial cable. This leads the antenna signal to the receiver input but not the noise voltage interference. This results in a vital improvement in the quality of reception.

With its special matching transformer, it enables you to use an insulated stay, with a length between 6 and 25 metres, as an antenna for a reception range from 100kHz to 30MHz.

An over-voltage protection against electrostatic charging during lightning storms has been built in.

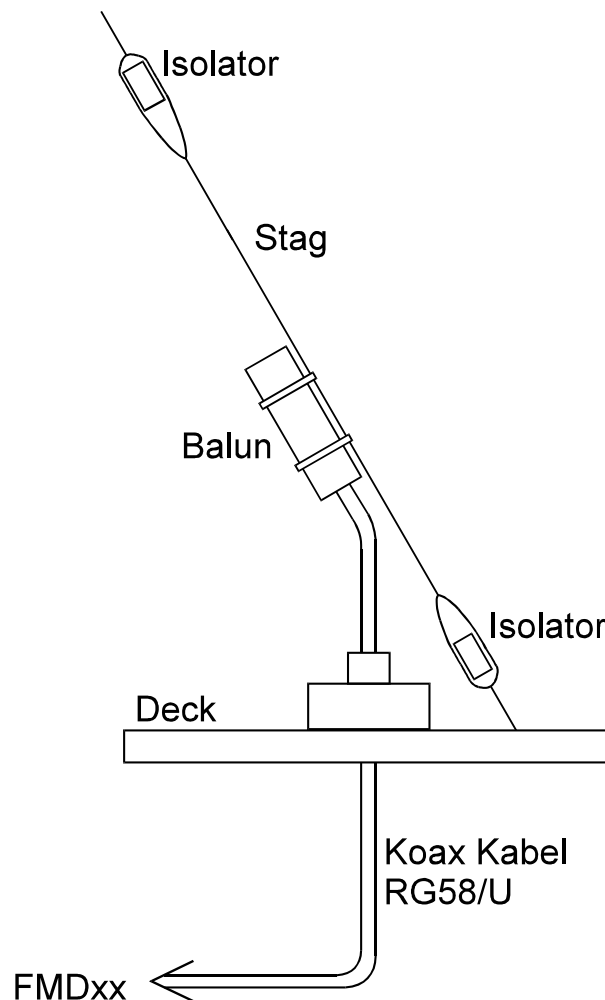

10.6. F3A / F6A suppression filter

Practically every piece of electrical or electronic equipment on board, which is connected to the vessel's power supply, such as the generator, the battery charger, pumps, refrigerator etc., cause disturbances within the power supply. This could interfere with the function of sensitive electronic equipment, such as a receiver.

This filter suppresses a great deal of such disturbance, which may reach the decoder via the power supply. It can be simply fitted between the power supply and the unit.

Should a filter be necessary only for the FMD25, then you require the F3A. When other units.g. GPS, FM, 2-way radio etc.) be attached, it is recommended to use the F6A.

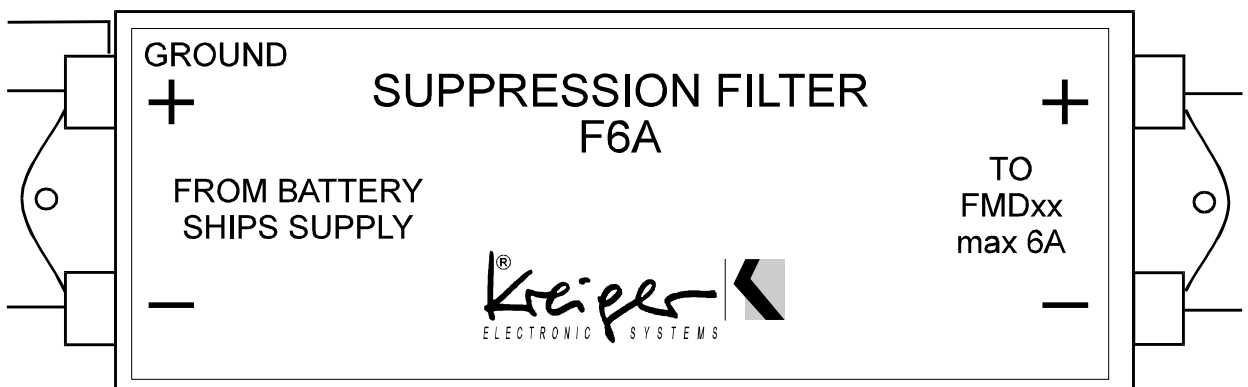
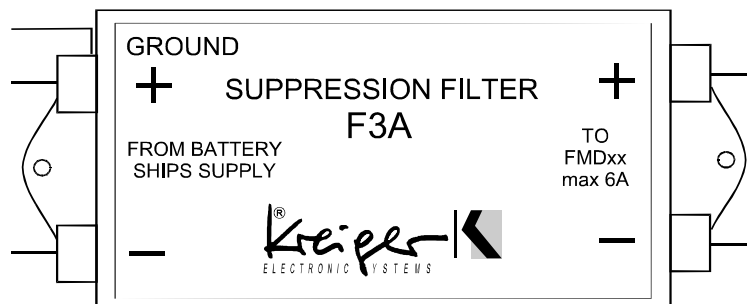



10.7. M20-ALS - active loudspeaker for FMD15 and FMD25

FUNCTION :

The FMD25 has no build in audio amplifier with loudspeaker to make the received signal audible. In the normal use of the FMD25 this function is not necessary.

To check the received signal after installation, to check the function of used antenna, to find out EMV distortions, for service and maintenance use, the audible signal can be very helpful.

The M20-ALS is an active loudspeaker with build in amplifier. Connected to the audio output of the FMD25 he makes the received signal audible.

The M20-ALS must be supplied with 12 V DC (10 to 15 V).

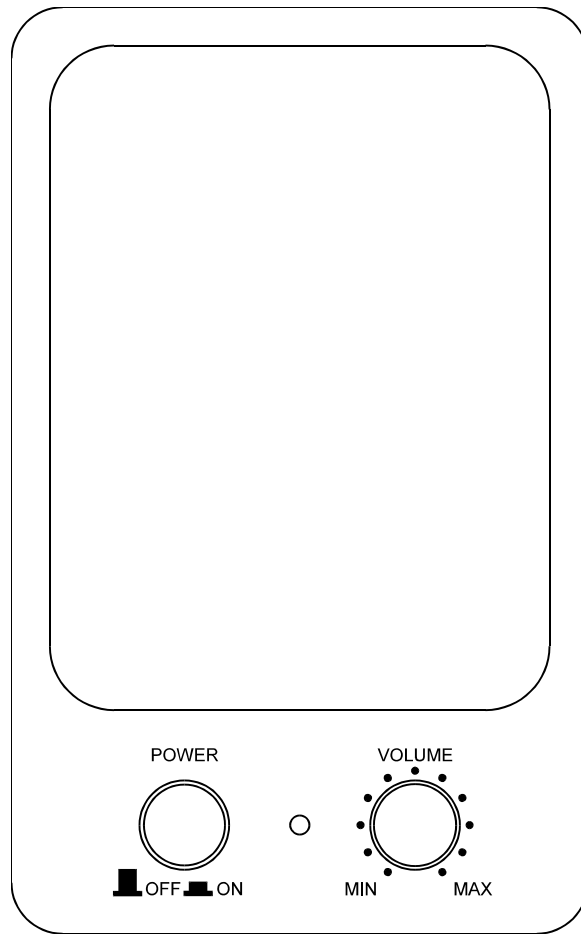

TECHNICAL INFORMATIONS

- Dimensions: 91 x 145 x 100 mm (WxHxD)
- Powersupply: 12 V DC (11...15V)
- Input signal: 3 V_{ss} max.
- Output power: 15 Watt peak max.
- Delivery content: Activ Loudspeaker Box
Power connection cable
Audio connection cable

Order number: M20-ALS

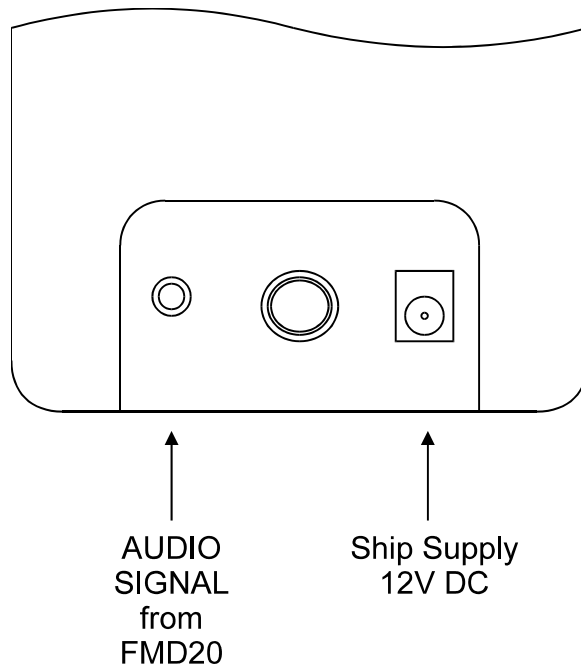

11. Technical Data

11.1. General:

Dimensions	: Receiver 222 (W) x 146 (H) x 55 (D) mm incl. brackets 288 (W) x 170 (H) x 65 (D) mm
Weight	: approx. 1.5 kg
Power Supply	: 12 V nominal (11 to 15 V DC), optional 18 to 36 V
Power Consumption	: 200 mA in Stand-by, 350 mA operating, 1,2 A printing
Fuse	: Spare Fuse, 2 A slow blow, 5x20mm

11.2. Receiver:

Frequency Range	: 490,0 and 518,0 kHz (Navtex) and 8 channels between 100 kHz to 11,8 MHz
Modulation	: AM, SSB (USB and LSB), FSK, CW
Receiver System	: Double Superheterodyne Receiver with PLL Synthesizer tuning
IF 1	: 44.999 to 45.000 MHz
IF 2	: 455 kHz
1. ZF Filter	: 45 MHz / 15 kHz
2. ZF Filter	: 2,2 kHz (6dB)
Audio Filter	: 900 - 1700 Hz
Display	: LCD panel display, showing Frequency, Operating mode - CW, FSK Field strength, Memory location
Antenna Input	: 50 Ohm asym., BNC Connector
Audio Output Power	: 1 Volts pp

11.3. Microcontroller

System Processor	: SAB80C535 Siemens
Program Memory	: 64K x 8 EPROM
Data Memory	: 32K x 8 Static RAM
System Clock	: 15,360 MHz

11.4. Signalconverter - Decodeer

Converter	: NF PLL lock system
Decoding	: Morse 40 tp 100 Bpm RTTY 50 Baud SITOR 100 Baud NAVTEX
Timer	: 9 - user programmable

11.5. LCD Display

Display module	: L2014 Seiko or aquivalent
Display area	: 71 X 21 mm
Resolution	: Text mode 4 lines 20 rows
Backlight	: LCD Backlight

11.6. Printer

Printer mechanism	: MTP 401 Seiko
Printer head	: Thermal head printer
Resolution	: 5 x 7 pixel per character
Printer speed	: 0,6 characters per second
Paper width	: 80 mm, Print width 67 mm
Print head life	: 5×10^7 characters, 30 km

11.7. NMEA Interface

Interface	: NMEA 0183
Baud rate	: 4800 baud
Data String	: \$xxRMC

11.8. Supply for Active Antenna

Supply	: nom. 12 V
Current	: max. 250 mA
Fuse	: Spare Fuse, 500 mA slow blow, 5x20mm

11.9. Approvals

CE Conformity Explanation
Inspected by IEC 945 3rd edition
Basic Standard for GMDSS Equipment

12. Information, Stations, receiving conditions

12.1. Stations, Frequencies and Transmission Times

The most complete and exact listing is to be found in the

Admiralty List of Radio Signals Volume 3 Radio Weather Services and Navigational Warnings

An annually up-dated edition is issued by :

Hydrographer of the Navy Admiralty List of Radio Signals

Taunton Somerset TA1 2DN United Kingdom

Tel: +44 1823 337900

Fax: +44 1823 334752

This book can be purchased in every qualified nautical bookshop.

Fastnet Radio prepare the latest information for the most important sailing regions in Europe and can be down-loaded from the web sites :

www.fastnet-radio.com

or

www.kreiger.eu

12.2. Chart W3 United Kingdom GMDSS Metarea 1

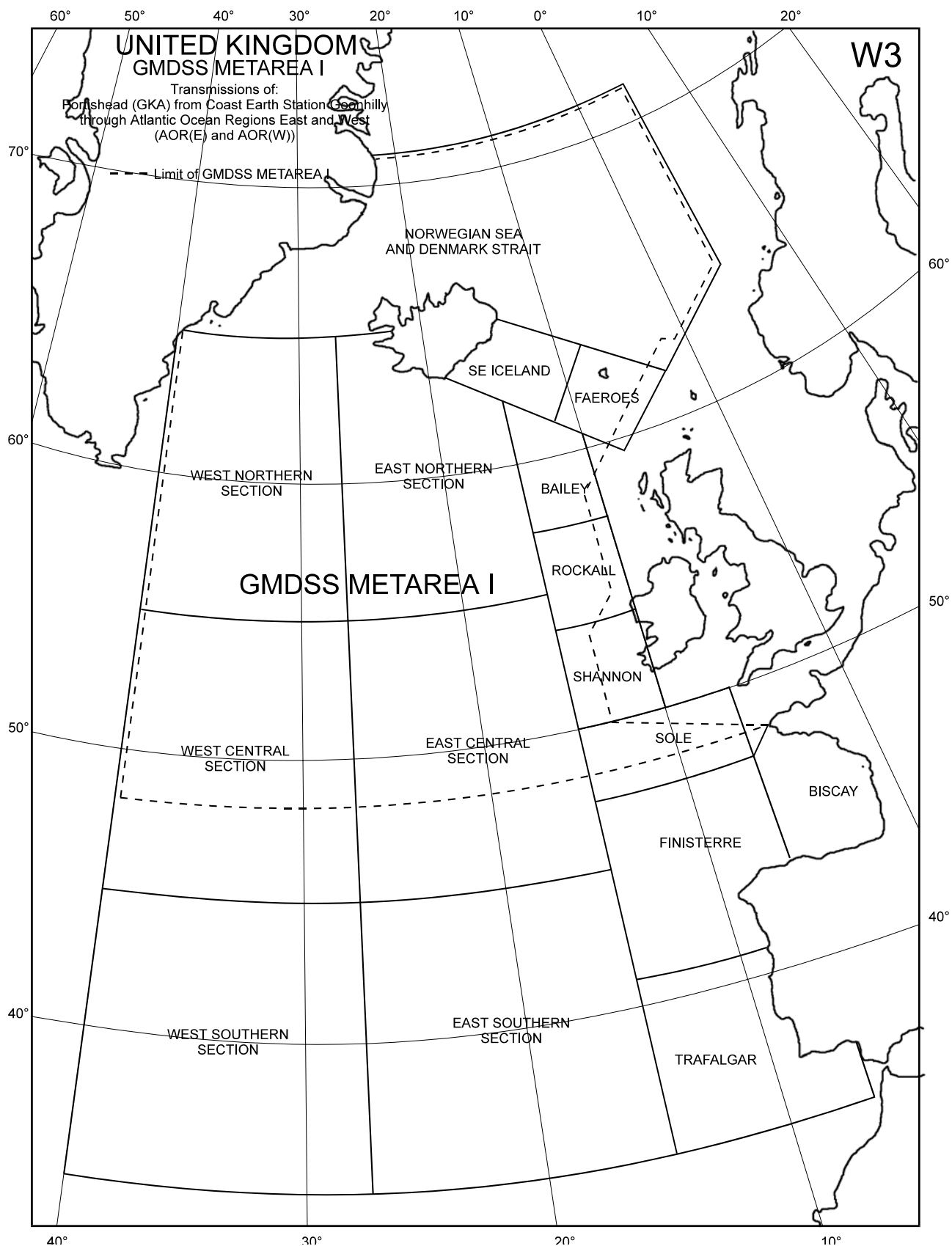

12.3. Chart W4 United Kingdom Forecast Areas

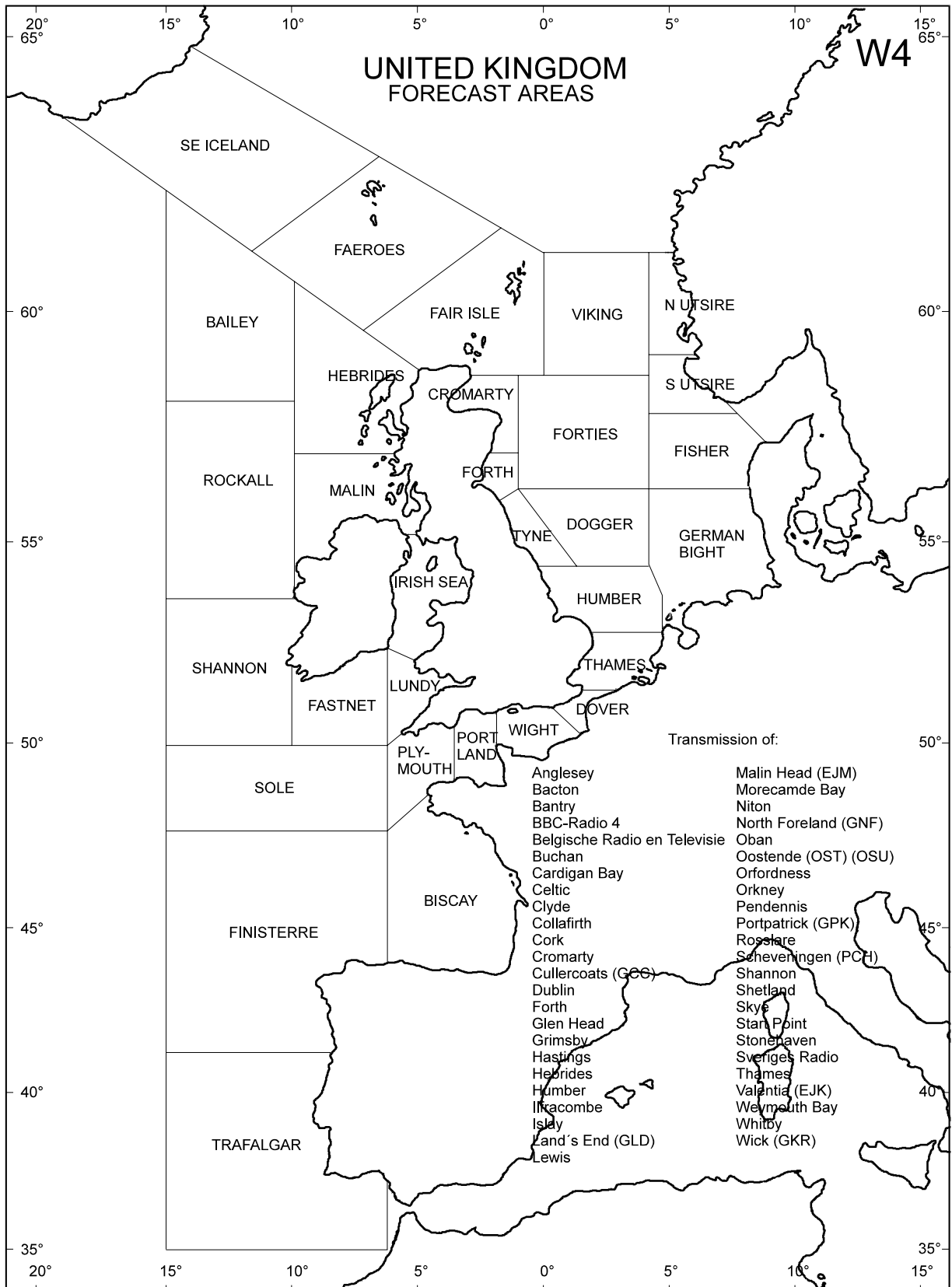



12.4. Chart W5 Baltic Sea

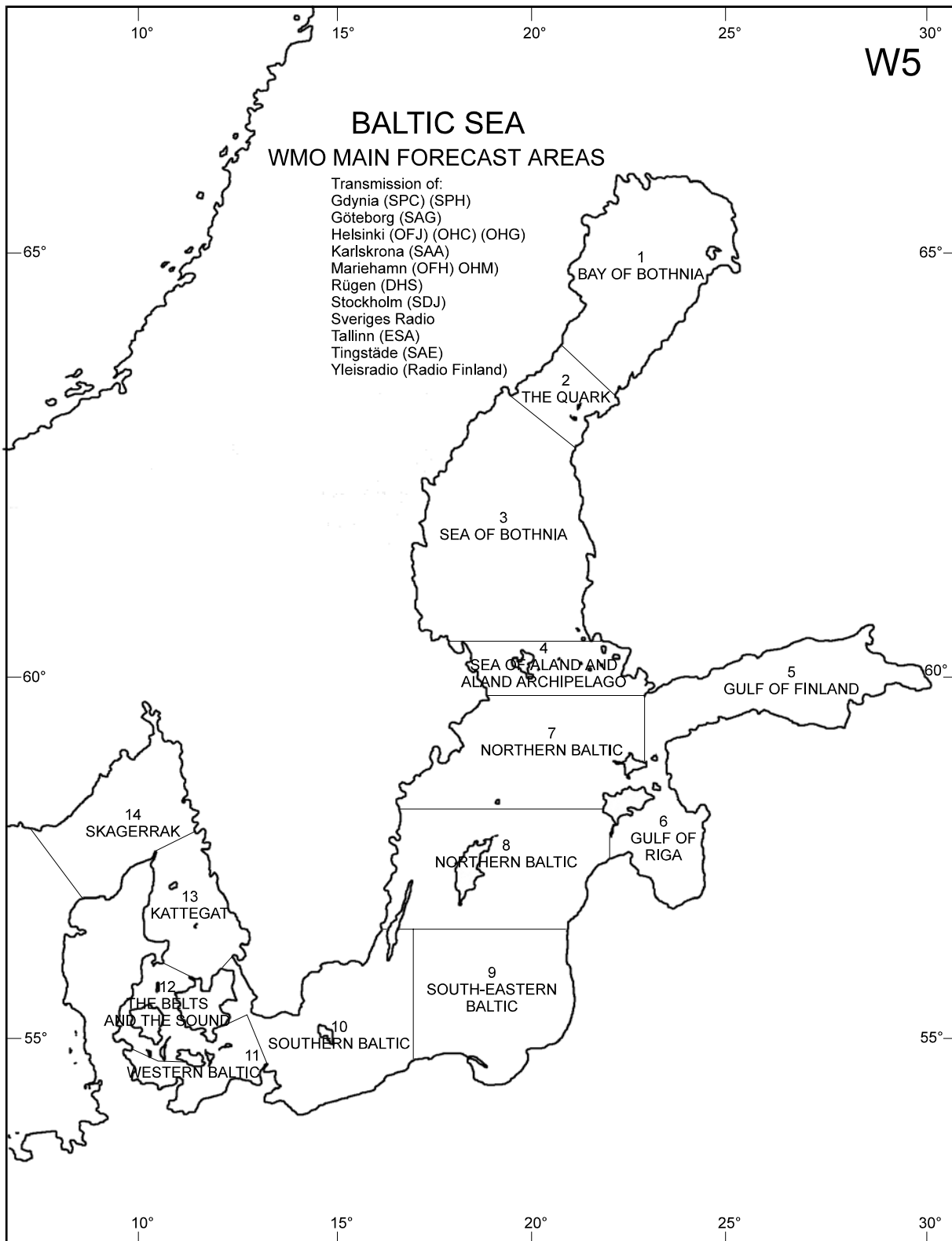

12.5. Chart W6 Germany Forecast Areas

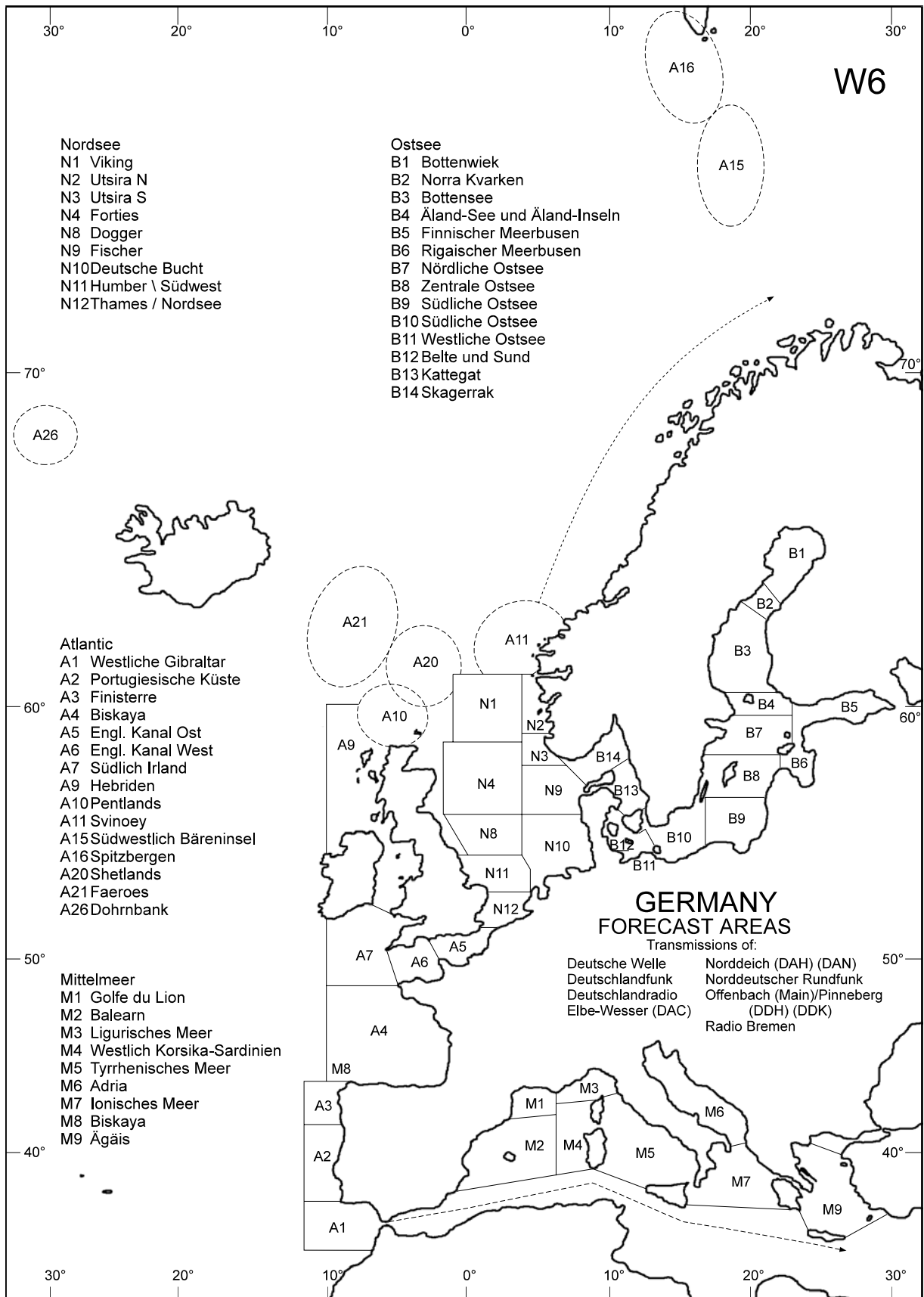

12.6. Chart W8 Denmark Forecast Areas

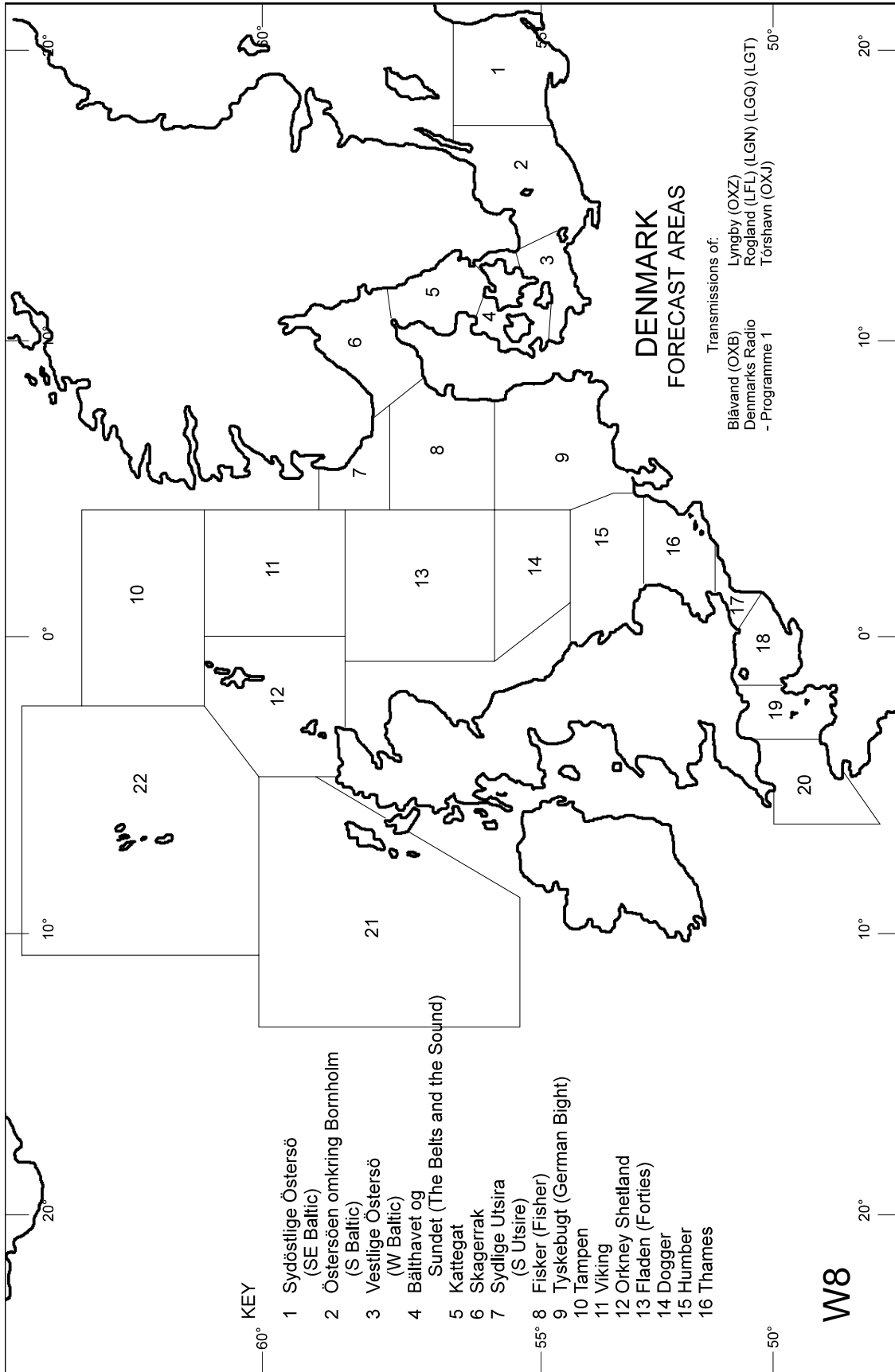

12.7. Chart W12 France Forcast Areas

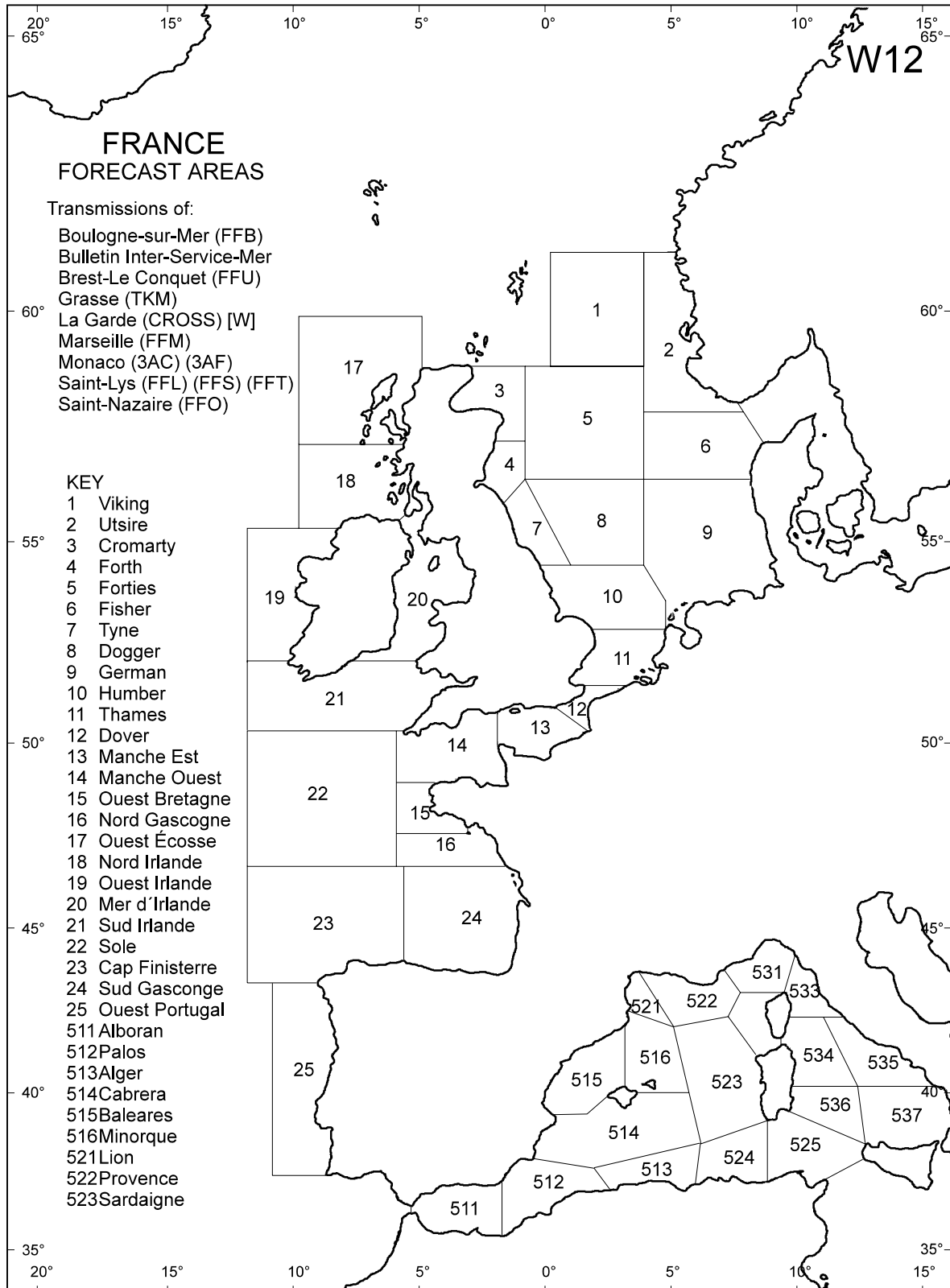

12.8. Chart W18 Greece Forecast Areas

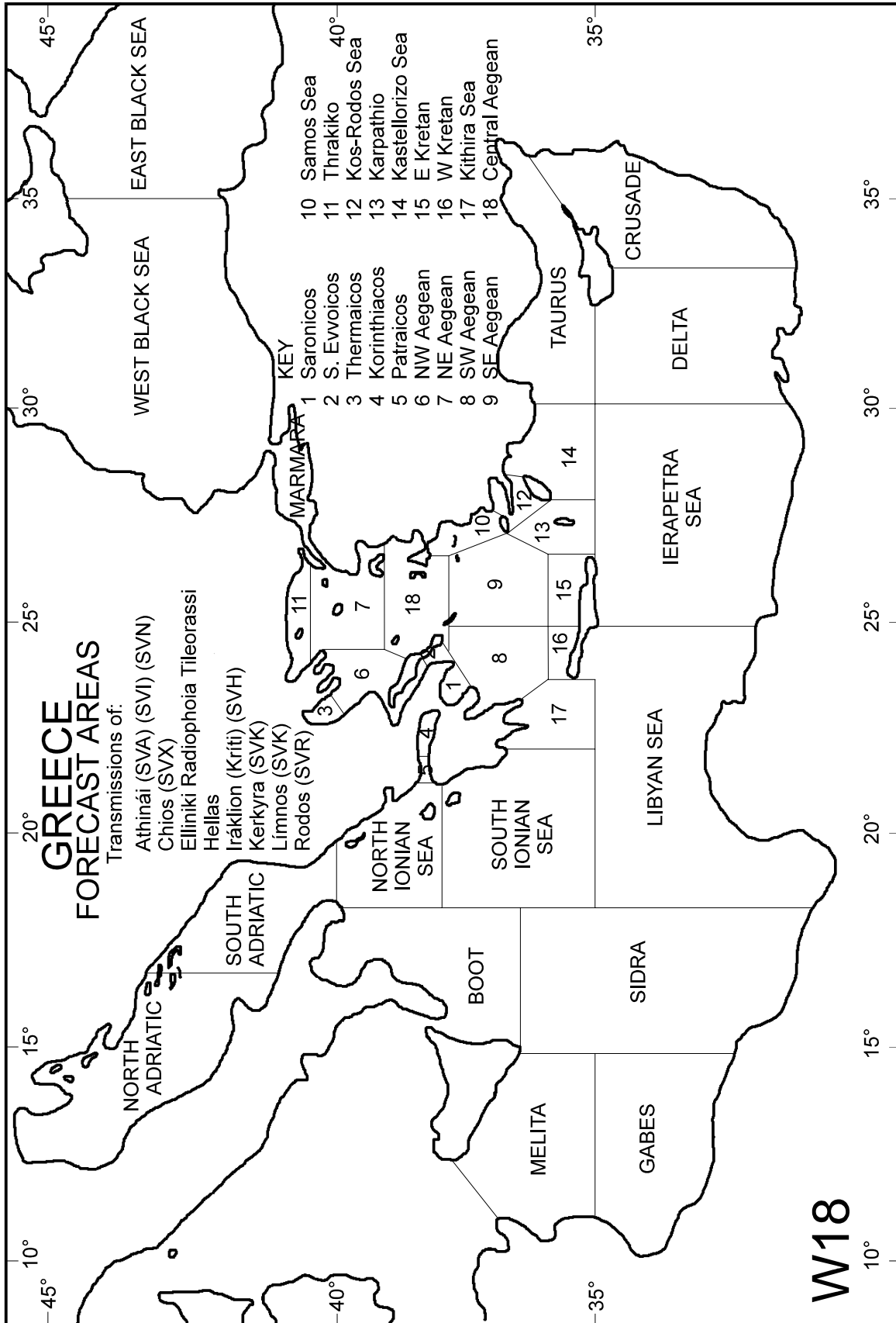

12.9. Chart W19 Mediterranean Fleet Forcast Areas

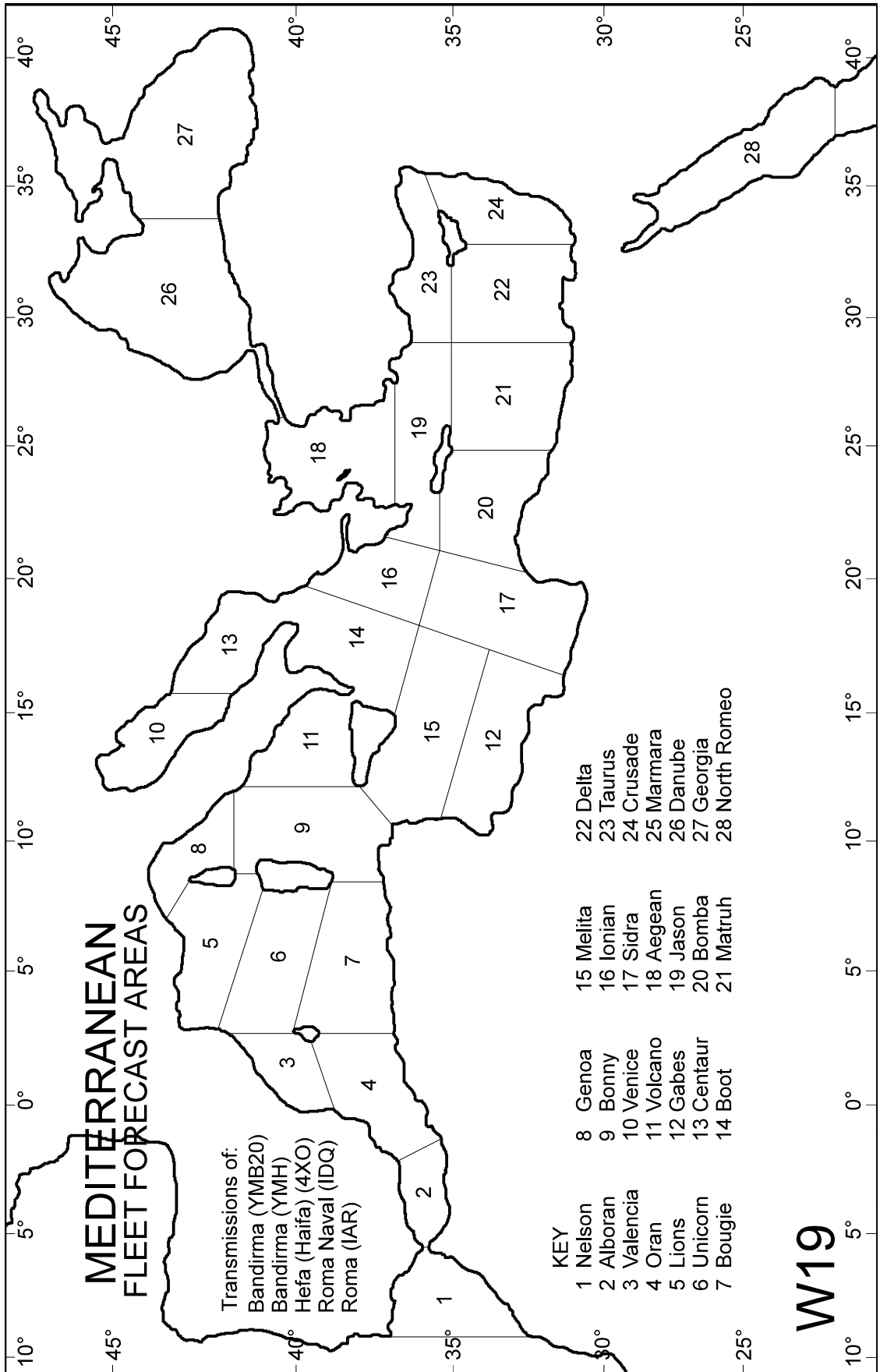



12.10. Beaufort Scale of Wind

Beaufort-Skala	Bezeichnung deutsch	Bezeichnung englisch	Mittlere Windstärke in m/s	Mittlere Windstärke in kn	Bezeichnung in der Wetterkarte
0	Stille	calm	< 0,2	< 1	
1	Leiser Zug	light air	0,3 - 1,5	1 - 3	
2	Leichte Brise	slight breeze	1,6 - 3,3	4 - 6	
3	Schwache Brise	gentle breeze	3,4 - 5,4	7 - 10	
4	Mäßige Brise	moderate breeze	5,5 - 7,9	11 - 15	
5	Frische Brise	fresh breeze	8,0 - 10,7	16 - 21	
6	Starker Wind	strong breeze	10,8 - 13,8	22 - 27	
7	Steifer Wind	moderate gale	13,9 - 17,1	28 - 33	
8	Stürmischer Wind	fresh gale	17,2 - 20,7	34 - 40	
9	Sturm	strong gale	20,8 - 24,4	41 - 47	
10	Schwerer Sturm	whole gale	24,5 - 28,4	48 - 55	
11	Orkanartiger Sturm	storm	28,5 - 32,6	56 - 63	
12	Orkan	hurricane	> 32,6	> 63	



12.11. Beaufort Scale of Waves

See also table on page 417 of the Admiralty List of Signals NP 283(1).

See- Gang- Skala	Bezeichnung des Seegangs	Auswirkung
0	Vollkommen glatte See	Spiegelglatte See
1	Ruhige, gekräuselte See	Kleine schuppenförmig aussehende Kräuselwellen, keine Schaumkämme
2	Schwach bewegte See	Wellen noch kurz, aber ausgeprägter. Kämme sehen glasig aus und brechen sich nicht. Vereinzelt weiße Schaumköpfe
3	Leichte, bewegte See	Wellen noch klein, werden aber länger. Ziemlich verbreitet treten weiße Schaumköpfe auf. Die sich brechende See rauscht
4	Mäßig bewegte See	Wellen länger, ausgeprägter. Überall weiße Schaumköpfe Schaumköpfe. Vereinzelt schon Gischt. Brechen der See hört sich wie Murmeln an.
5	Grobe See	Größere Wellen, Kämme brechen sich und hinterlassen größere weiße Schaumflächen. Dumpfes rollendes Geräusch der sich brechenden See.
6	Sehr grobe See	See türmt sich. Der beim Brechen entstehende weiße Schaum beginnt sich in Streifen in die Windrichtung zu legen. Das Geräusch der sich brechenden See ist in größerer Entfernung hörbar.
7	Hohe See	Mäßig hohe Wellenberge mit Kämmen von beträchtlicher Länge. Von den Kanten der Kämme beginnt Gischt abzuwehen. Der Schaum legt sich in ausgeprägten Streifen in die Windrichtung.
8	Sehr hohe See	Hohe Wellenberge mit langen, überbrechenden Kämmen. See ist weiß durch Schaum. Schweres, stoßartiges Rollen der See. Die Sicht ist durch Gischt stark beeinträchtigt.
9	Außergewöhnlich schwere See	Außergewöhnlich hohe Wellenberge. Die See ist völlig weiß. Die Luft ist mit Schaum und Gischt angefüllt. Jede fernsicht hört auf. Das Rollen der See wird zum Getöse.



12.12. Propagation of SW Signals

One of the questions raised frequently is to determine which transmissions can be received at what distance from the transmitter. There is a number of factors that affect Short Wave reception and distance vary greatly depending on time of day and year, sun activity and amount of traffic in a particular band. Each band has its own characteristics and as a rule of thumb one could say 'the higher the frequency, the higher the distance', at least during day time. At night there is also a considerable increase in the distance for low frequency bands. For instance, a typical transmitter in the 4 MHz band would cover a distance of 250 nm around noon time which would increase to as much as 2,500 nm at night. The following comparison looks at the various bands their respective propagation characteristics.

2 MHz Band: Maximum distance during day time is about 60 nm which increases at night to 200 nm under good conditions. Thunder storms and lightning severely affect reception quality.

4 MHz Band: Reception in this band works best in the early morning hours with a gradual decline towards noon time. Towards the evening propagation may exceed 2000 nm. Reception of transmitters in closer proximity may not be possible.

8 MHz Band: Best propagation during the early morning hours. Distances up to 800 nm should be possible during the entire day. Reception of transmitters in closer proximity may not be possible.

12 MHz Band: Until late afternoon no long distance coverage. Thereafter propagation increases gradually but transmitters located within 600 nm may not be received.

16 MHz Band: This band is similar to the 12 MHz band. Reception of stations within 800 nm is not normally possible. In the late evening hours propagation increases to 6000 nm.

22 MHz Band: This band is not normally usable for stations located within 1000 nm. under good atmospheric conditions distances of up to 8000 nm may be covered. Best connections are obtained in North / South direction. Right after sunset this band is not usable.

12.13 Empfangsantennen auf Schiffen

Radio receivers are today standard equipment on board sea-going vessels.

In most cases it is seldom taken into account, that every receiver, no matter how expensive it is, can only function as good as its antenna.

What should one take into consideration when choosing an antenna?

The frequency range of the antenna must have the same range as the receiver, at least have the same range that is going to be used.

The output impedance of the antenna must match the input impedance of the receiver. In other words, the antenna and the receiver must conform.

The antenna and the cables leading to the receiver should transmit the least possible interference to the receiver. This entails proper grounding of the receiver and the antenna.

Receivers used in the maritime sector are usually 100 kHz to 30 MHz, i.e. are designed for use in the lowest LW ranges to the highest SW range. This corresponds to a wave range of approx. 3000 to 10 metres, an extremely vast range. Since the ratio of the length of an adapted antenna is always in fixed proportion to the wave-length, it is understandable that a long-wire antenna of a certain length can only be correctly adapted to one single frequency. Therefore, when using a long-wire antenna such as an insulated back-stay, it is necessary to fit between the antenna and the receiver cable, a suitable adapter. Such adapters exist (e.g. MLB marine longwire balun), which solve the problem as adapter with a large frequency range between the longwire and the shielded lead cable quite satisfactorily. The antenna itself should be as high as possible and installed as far away as possible from local disturbances. Practically every electric and electronic piece of equipment transmit interference signals which should not reach the unit via the antenna. New equipment with corresponding approvals or CE seals have been designed and constructed, free of disturbance as far as is possible. Measurements must be taken to make older units free of interference. The lead from the antenna to the receiver must be a non-



dissipative well shielded coaxial cable with the same impedance as the receiver input. These are usually laid parallel to other (disturbing) cables and near other electrical devices. A badly shielded cable picks up local interference and transmits them to the receiver. The receiver itself should be connected at the shortest possible distance to a grounding sponge.

Alternatively an active antenna can be used. The input resistor in the amplifier of an active antenna is very high, therefore it requires a very short whip. The output resistor of the amplifier is 50: throughout the whole of the specified frequency range, so that a corresponding coaxial cable also with 50: which transmits the signal from the antenna without further loss of adaptation. The difficulty in the realisation of a good active antenna is that the integrated amplifier and the impedance transformer are as linear as possible and not overmodulated by strong signals from nearby transmitting stations creating self generated interference to the receiver. This is normally only possible with powerful amplifiers with equally high voltage use demands finding a good solution between highest possible linearity and the least amount of draw of current. Because of the small dimensions, it is easier to find a place for mounting an active antenna away from disturbing influences. The lead to the receiver through the shielded coaxial cable is uncritical. The use of a high quality active antenna will give an optimum reception.



12.14. MORSE Code Table

The FMD25 will recognise the following code and translate accordingly:

MORSE Code	Character	Remarks
• —	A	
• — • —	Ä	
• — — • —	Å, Á	displayed as „a“
— • • •	B	
— • — •	C	
— — — —	CH	
— • •	D	
•	E	
• • — •	F	
— — •	G	
• • • •	H	
• •	I	
• — — —	J	
— • —	K	
• — • •	L	
— —	M	
— •	N	
— — • — —	Ñ	displayed as „n“
— — — —	O	
• — — •	P	
— — • —	Q	
• — •	R	
• • •	S	
—	T	
• • —	U	
• • — —	Ü	
• • • —	V	
• — —	W	
— • • —	X	
— • — —	Y	
— — • •	Z	



MORSE Code	Character	Remarks
• - - - -	1	
• • - - -	2	
• • • - -	3	
• • • • -	4	
• • • • •	5	
- • • • •	6	
- - • • •	7	
- - - • •	8	
- - - - •	9	
- - - - -	0	
- • - - • -)	Closing Parenthesis
- • - - •	(Opening Parenthesis
- • • - •	/	Slash
- • - • - •	+	Plus symbol
- - - • • •	:	Colon
• - • - • -	.	Period
- • • • -	=	Equal symbol / new line
• • - - • •	?	Question mark
- - • • - -	,	Comma
• - • • - •	„	Quote symbol
- • • • • -	-	Minus Symbol, Hyphen
• - - - - •	'	Apostrophe, Accent
- • - • -	!_	Exclamation mark
- • - • -	_+_	End of message
• • • - • -	_sk_	End of transmission
• • • • • • • •	_err_	Error
• - • • •	-w-	Please wait
• - • • -	_ - _	Hyphen
• • • - - - • • •	_sos_	Distress Call

Other national special signs or distorted characters are shown as an asterisk (*)



13. Examples

13. 1. Station / Timer Programming

(Example North-Atlantik / North-Baltic Sea)

STATUS-INFORMATION

GPS-LOG : TIME: 99min DISTANCE: 3nm

STORED FREQUENCY CHANNELS:

CH	FREQUENCY	MODE	ME	PR	STATION
01	147kHz	RTTY	Y	Y	Pinneberg
02	438kHz	MORSE	Y	Y	Lyngby
03	6.315kHz	SITOR	Y	Y	Portishead
04	4.583kHz	RTTY	Y	Y	Pinneberg
05	7.646kHz	RTTY	Y	Y	Pinneberg
06	4.211kHz	SITOR	Y	Y	Portishead
07	8.417kHz	SITOR	Y	Y	Portishead
08	10.100kHz	RTTY	Y	Y	Pinneberg

PROGRAMMED TIMER FUNCTIONS:

1. from 5:30 to 5:40 -> CH 1 Report, 12-hours Forecast
2. from 6:02 to 6:06 -> CH 1 Station-Message
3. from 10:35 to 10:50 -> CH 1 2-day Forecast
4. from 11:12 to 11:35 -> CH 1 5-day Forecast

GMDSS MARINE RADIO DECODER FMD25 2.1x

SHIP OWNER

ATTENTION!

The actual transmitting times can be found in the Admiral List of Radio Signals Volume 3 Part 1+2, the "Nautischen Funkdienst" or the "Yachtfunkdienst". Fastnet Radio informs you also about the actual transmission schedules and most important transmitting stations. See also web page

www.fastnet-radio.com and

www.kreiger.eu



13. 2. Station / Timer Programming (Example North-Atlantik / East-West Mediterranean Sea)

STATUS-INFORMATION

GPS-LOG : TIME: 99min DISTANCE: 3nm

STORED FREQUENCY CHANNELS:

CH	FREQUENCY	MODE	ME	PR	STATION
01	4.202kHz	MORSE	Y	Y	Roma Meteo
02	4.343kHz	MORSE	Y	Y	Athen
03	6.315kHz	SITOR	Y	Y	Portishead
04	6.964kHz	MORSE	Y	Y	Bandirma
05	7.646kHz	RTTY	Y	Y	Pinneberg
06	8.530kHz	MORSE	Y	Y	Roma Meteo
07	11.039kHz	RTTY	Y	Y	Pinneberg
08	10.100kHz	RTTY	Y	Y	Pinneberg

PROGRAMMED TIMER FUNCTIONS:

1.	from	0:50	to	1:20	->	CH 1	Report,IAR-ROMA
2.	from	5:37	to	6:02	->	CH 8	5-day Forecast
3.	from	9:40	to	10:05	->	CH 8	2-day Forecast
4.	from	17:18	to	17:33	->	CH 8	Station-Message

GMDSS MARINE RADIO DECODER FMD25 2.1x

SHIP OWNER

ATTENTION!

The actual transmitting times can be found in the Admiral List of Radio Signals Volume 3 Part 1+2, the “Nautischen Funkdienst” or the “Yachtfunkdienst”. Fastnet Radio informs you also about the actual transmission schedules and most important transmitting stations. See also web page

www.fastnet-radio.com and

www.kreiger.eu



13.3. Example NAVTEX Printout

Navtex message, Station Cullercoast, England

WZ 514
DOVER STRAIT. SANDETTIE LIGHTVESSEL 51-0
9N 01-47E FOG SIGNAL
UNRELIABLE.
NNN
NAVTEX 518 kHz GA04 12-03-94 0:53UTC

Navtex message, Splitradio

SLITRADIO NAV WNG 243/92

SINCE DEC 16TH 1992 N OF CLIFF MULO (43
31 06 N-15 55 30 E)
ANCHORED WAVEGRAPHIC STATION MAKED WITH
W-FLASHING LIGHT.
500 MTRS BERTH REQUESTEDE.

NNN
NAVTEX 518 kHz QA08 11-03-94 22:58UTC

Navtex message, Oostende Radio

241100 UTC DEC =
OST INFO 226/93 =
POS DOVER STRAIT AND RRENCH BEACHES
PLASTIC BAGS WITH DANGEROUS AND TOXIC
CHEMICALS IN POWDER ARE FOUND
SOME BAGS ARE DAMAGED AVOID TOUCHING
BAGS OR CHEMICALS
BAGS ARE EXPECTED TO BE OFF BELGIA COAS
T ON THE 26TH OF DECEMBER
NNN
NAVTEX 518 kHz TA23 10-2-94 02:10UTC



13.4. Example of Weather Report

North-Baltic Sea, Station Pinneberg

STURM - WARNUNG NORDSEE NR.: 213, DAT:
14.03.1994, 15.30 UHR UTC
DEUTSCHE BUCHT GEFAHR SUEDEWEST BIS WEST
8.
SUEDEWESTLICHE NORDSEE GEFAHR SUEDEWEST
BIS WEST 8.
DOGGER GEFAHR WEST 7.
FORTIES GEFAHR WEST 8.
FISCHER GEFAHR WEST BIS NORDWEST 10.
UTSIRA GEFAHR NORDWEST BIS WEST 9.
VIKING GEFAHR WEST 8.
SKAGERRAK GEFAHR WEST 10.

STORM - WARNING NO.: 126, DATE 14.03.19
94, 15.30 UTC
RISK OF WESTERLY GALES FORCE 9 FOR WESTE
RN BALTIC,
RISK OF SOUTHWESTERLY TO WESTERRMS FORCE
10, VEERING FOR
SOUTHERN BALTIC.

STORM - WARNING OSTSEE NR.: 188, DATUM
: 14.03.1994, 15.30 UHR UTC
SKAGERRAK UND KATTEGAT GEFAHR WEST 10. EX
ELTE UND SUND SOWIE WESTLICHE OSTSEE
GEFAHR WEST 9.
SUEDLICHE OSTSEE GEFAHR SUEDEWEST BIS
WESTKURECHTDREHEND.
SUEDEOSTLICHE OSTSEE GEFAHR SUEDEWESTXON
ROCHTYREHEND.
ZENTRALE OSTSEE GEFAHR SUEDE BIS SUEDEWEST
7, RECHTDREHEND.

SEEWETTERAMT=

13.5. Example Printout Navigation Log

Navigations Log (Printout)

N A V I G A T I O N S L O G : 131293

TIME	LAT	LONG	SPEED	COU
061503	3338.129 N	01419.234 W	08.5	315
063003	3339.635 N	01420.728 W	08.4	318
064502	3340.173 N	01422.137 W	08.5	317
070005	3341.657 N	01423.638 W	08.3	316
071508	3342.098 N	01425.125 W	08.2	317

13.6. Example NAVTEX Status-Information

NAVTEX - STATUS - INFORMATION:

FREQUENCY: 518kHz
FILTER: OFF
STATIONS: ABCDEFGHIJKLMNOPQRSTUVWXYZ
MESSAGES: ABcDEfghIjKlMnOpqrStUvwXyZ
DIRECT PRINT: YES
REPEAT: YES
ALARM: NO
STORED MESSAGES:
GB59 GA78 GL01 GA72 GA70 GL21 GL19 GA53
GA50 TA61 TA53 TA31 TA03 TA23 SA28 SA27
SL07 SA19 SA17 SA05 SA72 SA68 SA60 SA08
SA95 GA53 SB24 DB86 SB24 SA28 SL07 SA19
SA05 SA72 SA68
GMDSS MARINE RADIO DECODER FMD25 2.1x
FASTNET LADY FASTNET RADIO





14. Addendum

14.1. Service and Maintenance

Your FMD25 has been designed to require only a minimum of Maintenance. When changing paper rolls it is advisable to ascertain that dust that may have collected in the paper compartment is removed. There are no parts inside the case and service should be left to qualified personnel.

14.2. Service Organisations

This product has been designed and manufactured to the highest standards and has undergone rigorous testing in extreme environments. In the unlikely event that service may be required the unit should be returned to the dealer from which it was purchased. If that presents a problem then service is available from any of the following organisations:

KREIGER Gesellschaft m.b. H.

Mr Eduard Kreiger

Feschnigstraße 72

A 9020 Klagenfurt

Tel: +43 463 43390

Tel: +43 664 18 17 985

Fax: +43 463 43390 4

Mail kreiger@aon.at

Web www.kreiger.eu

Whenever a unit is returned for servicing please include a complete fault description, a copy of your warranty card and / or proof of purchase.

14.3. Warranties

Fastnet Radio resp- Kreiger GesmbH guarantees, that each product is delivered faultless, in material and production, in accordance with the specifications.

The guarantee lasts for 12 months from the date of purchase on parts and labour expenditure. In the case of Inmarsat-E emergency systems the guarantee begins as from the first registration of the unit by Inmarsat. Expendable parts such as electric bulbs, fuses, batteries, ball bearings etc., are not covered by this warranty.

Guarantee service will be carried out by Kreiger Ges.m.b.H. Products purchased from Fastnet Radio, which are returned, will be repaired during normal working hours or replaced. Freight costs or customs duties and other incidental charges are at the expense of the purchaser. The maximum guarantee costs must in no way exceed the original price of the unit.

Servicing. The demand for servicing must be exclusively in writing. Fastnet-Radio will then control further developments. It can be arranged that servicing on board be carried out by the nearest service partner. The man hours for the repair as well as the replacement of defect modules or other parts are free of charge as long as they are covered by the warranty. Overtime, waiting time, travel and hotel expenses, insurances, customs duties and other extra incidentals are at the expense of the purchaser. Additional costs involved in connection with testing or replacing of components such as docking, slipping, diving and protective measures and measurements are not covered by the Fastnet Radio warranty.

Validity: These warranty conditions are only valid when the warranty certificate or an invoice containing the serial number or the confirmation of registration of an emergency system device. In addition, the installation and the operation must be carried out in accordance with the operator manual. The obligations of the warranty are not valid for damages to the equipment which have been caused by improper handling, accident, damage, lack of service, water irruption or unauthorised repair work.



Fastnet-Radio does not take responsibility for loss also for reasons such as unforeseen damages emerging from contracts made elsewhere even though caused by faulty or unsatisfactory maintenance or in connection with the sale, the installation, the operation or repair of the product

For your information: Unforeseen damages range within a limited extent e.g. loss of profit,

14.4. Firmware Update

A great number of features of this product are controlled by software which is secured in 2 EPROM firmware chips. Changes in particular requirements as well as general product improvements can therefore be updated by simply exchanging new EPROM chips against those installed. This can normally be done by a skilled technician and your dealer will gladly assist you. This manual contains a coupon for one free update. Further updates are chargeable and should be ordered through your dealer or directly from Kreiger Ges.m.b.H. at the address mentioned above.

Up-date Enquiry :

should you have an enquiry, please fill out the attached form and send it to Kreiger Ges.m.b.H.

14.5. Error Alarm

The FMD25 has an integrated control function . In case of an error, an acoustic alarm will sound. This is a combination of short and long beeb tones.

14.5.1. „PRINTER-ERROR“ Alarm

Should there be a fault in the printer (e.g. paper jam or end of the paper roll), the display will show “PRINTER ERROR”, at the same time an alarm will sound in the form of two short beeps. This will occur every 15 minutes. Should the fault occur during the decoding of a message, the message will be stored automatically and after the fault has been rectified, the message can be printed out. In this case switch off the unit after the decoding is finished, rectify the fault and switch on the unit again. The “PRINTER ERROR” alarm can be turned off by switching the unit OFF/ON for a few seconds.



Attention: The unit must be switched off for at least 5 seconds so that internally, a total reset can take place and the unit can re-activate itself accordingly.

14.5.2 Further Acoustic Error Alarms

Nr.	Sequence	Explanation	Function
01	•	LCD driver	err_wait_01
12	--••	LCD driver	err_wait_2
02	-•	LCD driver	err_wait_3
04	--•	LCD driver	err_wait_016
03	••	Printer Function	err_prn
19	••--•	Time, date	err_RTC
20	--•-•	Time, date	err_RTC_set
21	•-•-•		err_sence

These error alarms can happen sporadically, caused by external or internal influence such as power fluctuation, interference in the power supply, static discharge etc. They can generally be reset by pressing the <**EXIT**> key. If this does not work,

Should this error alarm continue to occur, then most likely there is a fault in the unit and should be brought to one of the authorised service centres to be examined.



ENQUIRY

To
Kreiger Ges.m.b.H.
Feschnigstraße 72
A 9020 Klagenfurt
Austria

Subject : Firmware Update FMD25

Please send me information concerning a software up-date for the FMD25 to the following address:

Name : _____

Street : _____

ZIP / City : _____

Country : _____

Telefon : _____

Fax : _____

FMD25 : Serial Number : _____

Version Number : _____

Date of purchase : _____

A copy of the invoice is attached.

City, Date

Signature





Kreiger Ges.m.b.H.
Feschnigstrasse 72
9020 Klagenfurt
Austria

Tel.: +43 463 43390 0
Tel.: +43 664 18 17 985
Fax +43 463 43390 4
Email kreiger@aon.at
Internet www.kreiger.eu