

## 1 Scope

The present specifications shall apply to Sanken silicon diode, FMKS-2102.

## 2 Outline

Type	Silicon Diode
Structure	Resin Molded      Flammability: UL94V-0 (Equivalent)
Applications	High Frequency Rectification, etc. (FRD and SBD for temperature detection in a single package.)

## 3 Absolute maximum ratings (FRD)

No.	Item	Symbol	Unit	Rating	Conditions
1	Transient Peak Reverse Voltage	$V_{RSM}$	V	200	
2	Peak Reverse Voltage	$V_{RM}$	V	200	
3	Average Forward Current	$I_{F(AV)}$	A	10	$T_c=105.6^\circ\text{C}$ , sinewave
4	Peak Surge Forward Current	$I_{FSM}$	A	140	10ms. Half sine wave, one shot
5	$I^2t$ Limiting Value	$I^2t$	$\text{A}^2\text{s}$	98	$1\text{ ms} \leq t \leq 10\text{ ms}$
6	Junction Temperature	$T_j$	$^\circ\text{C}$	-40 to +150	
7	Storage Temperature	$T_{stg}$	$^\circ\text{C}$	-40 to +150	
8	Transient Peak Reverse Voltage		kV	A.C. 1.0	Junction and case (1min.)

4 Electrical characteristics of FRD for temperature detection ( $T_a=25^\circ\text{C}$ , unless otherwise specified)

No.	Item	Symbol	Unit	Value	Conditions
1	Forward Voltage Drop	$V_F$	V	0.98 max.	$I_F=10\text{A}$
2	Reverse Leakage Current	$I_R$	$\mu\text{A}$	100 max.	$V_R=V_{RM}$
3	Reverse Leakage Current Under High Temperature	$H \cdot I_R$	mA	6 max.	$V_R=V_{RM}$ , $T_j=150^\circ\text{C}$
4	Reverse Recovery Time	trr1	ns	50 max.	$I_F=I_{RP}=100\text{mA}$ 90% Recovery point, $T_j=25^\circ\text{C}$
		trr2	ns	35 max.	$I_F=100\text{mA}$ , $I_{RP}=200\text{mA}$ , 75% Recovery point, $T_j=25^\circ\text{C}$
5	Thermal Resistance	$R_{th(j-c)}$	$^\circ\text{C}/\text{W}$	4.0 max.	Between Junction and case.

5 Absolute maximum ratings of SBD for temperature detection

※SBD cannot be used for rectification.

No.	Item	Symbol	Unit	Rating	Conditions
1	Transient Peak Reverse Voltage	$V_{RSM}$	V	90	
2	Peak Reverse Voltage	$V_{RM}$	V	90	
6	Junction Temperature	$T_j$	°C	-40 to +150	
7	Storage Temperature	$T_{stg}$	°C	-40 to +150	

6 Electrical characteristics of SBD for temperature detection ( $T_a=25^\circ\text{C}$ , unless otherwise specified)

No.	Item	Symbol	Unit	Min.	Typ.	Max.	Conditions
1	Reverse Leakage Current	$I_{R1}$	$\mu\text{A}$	—	—	50	$V_R=15\text{V}$
		$I_{R2}$	mA	—	—	2.0	$V_R=90\text{V}$
2	Reverse Leakage Current Under High Temperature	$H \cdot I_{R1}$	mA	1.20	1.90	2.60	$V_R=15\text{V}, T_j=130^\circ\text{C}$
		$H \cdot I_{R2}$	mA	—	—	55	$V_R=90\text{V}, T_j=150^\circ\text{C}$

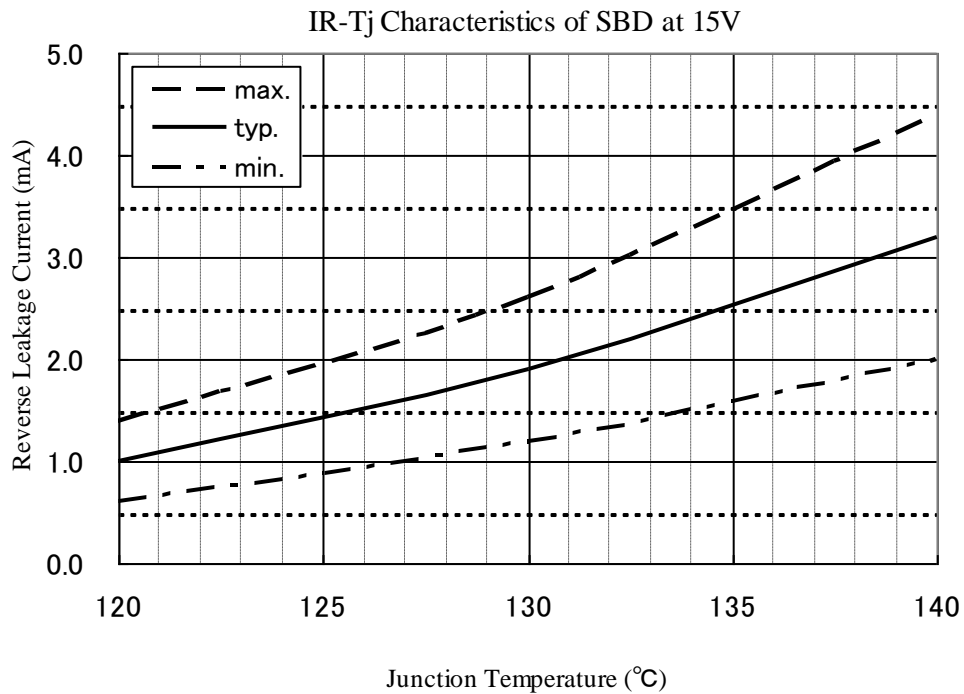

7 Characteristics

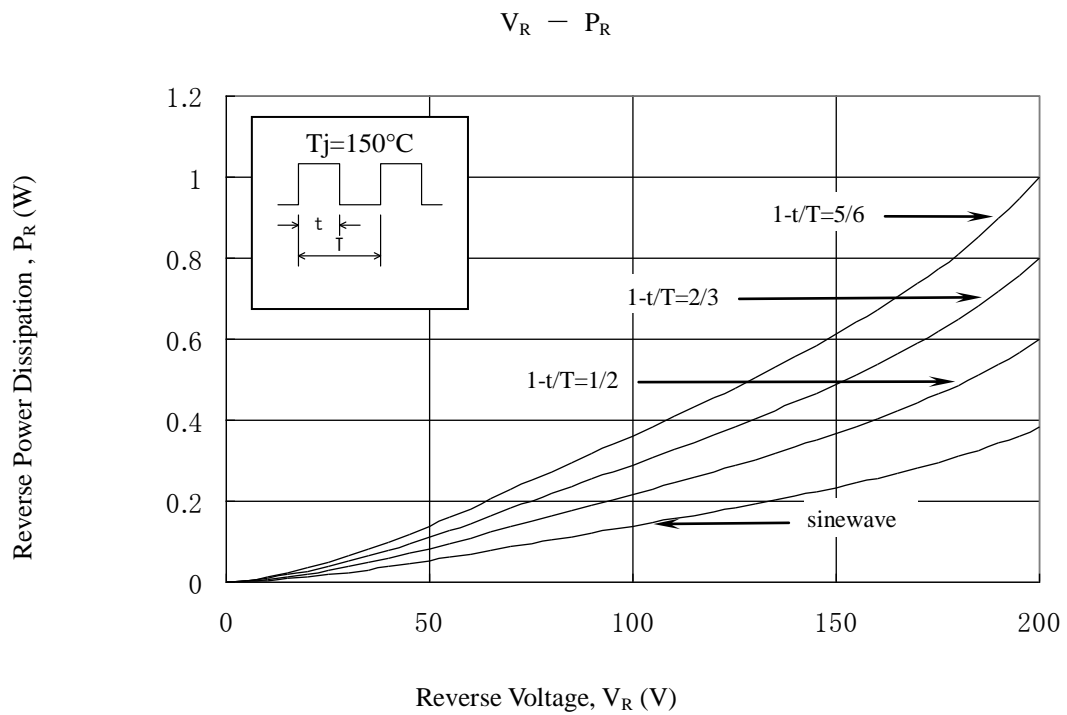
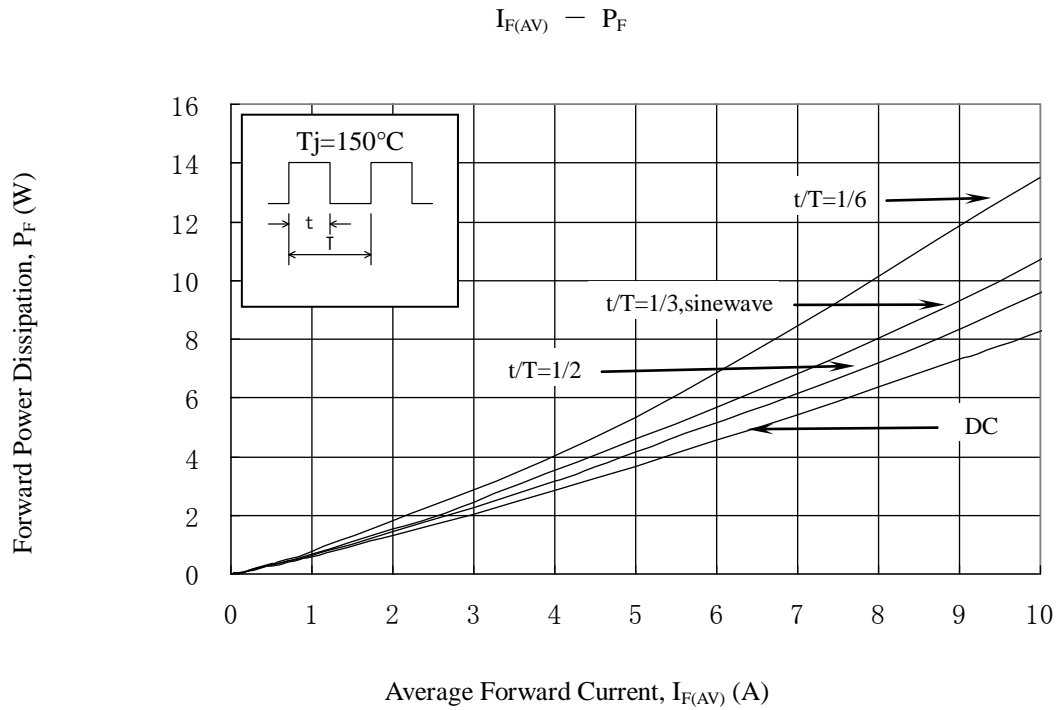

8 Derating

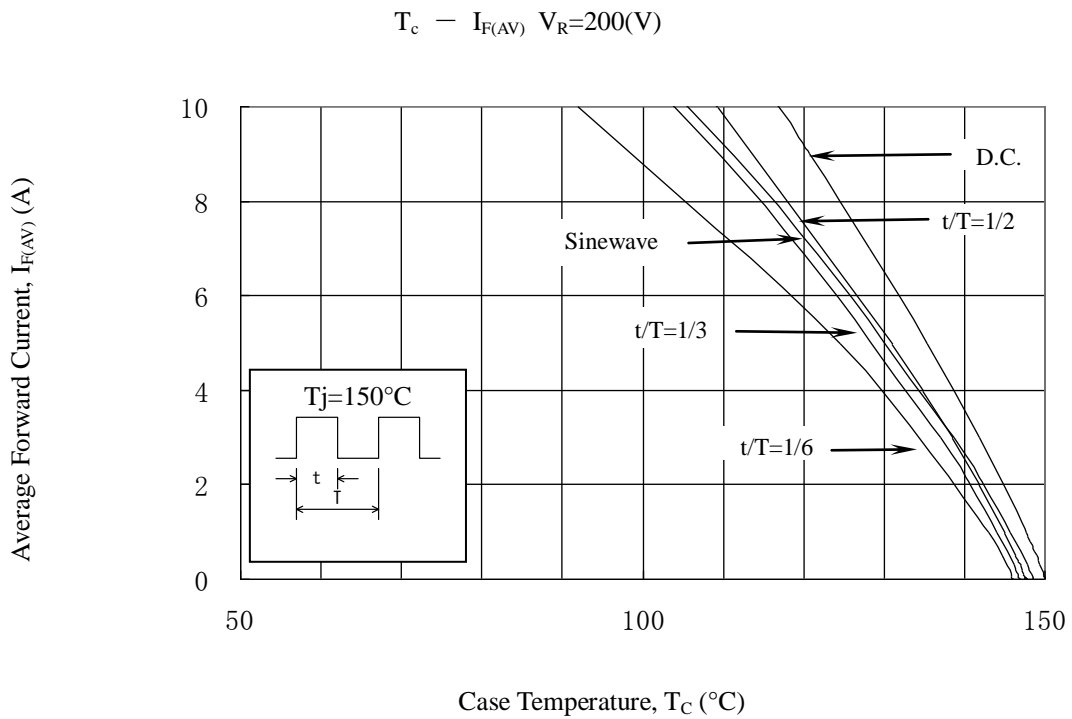
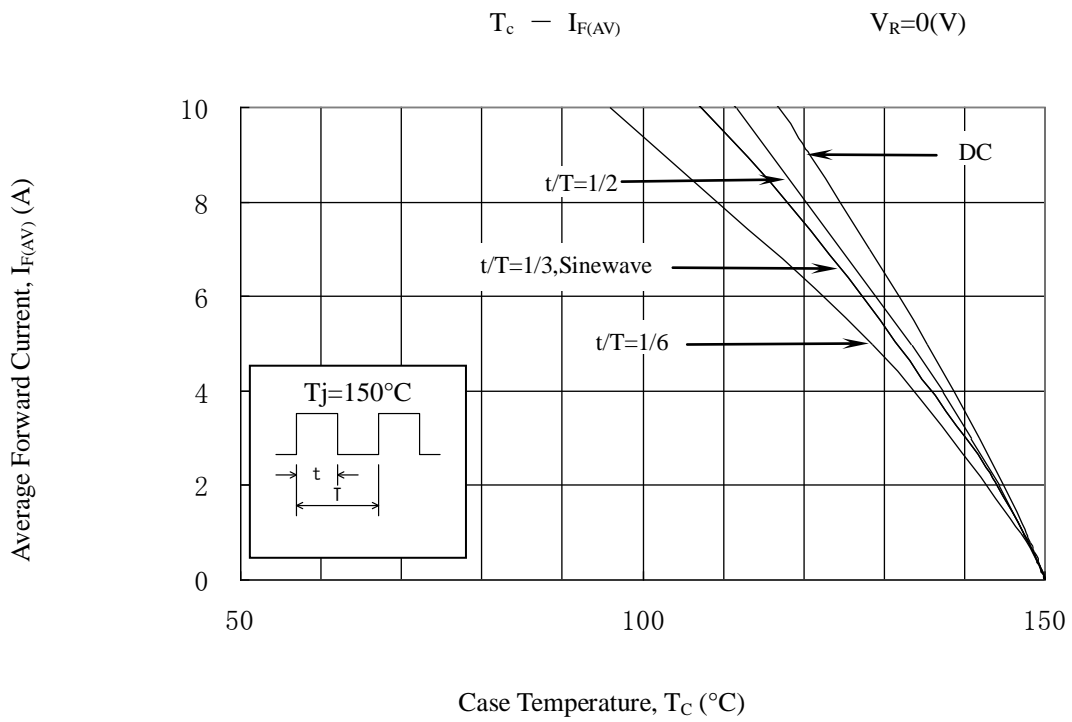

9 Dimensions, Inner Structure and Marking

9-1 Dimensions Refer

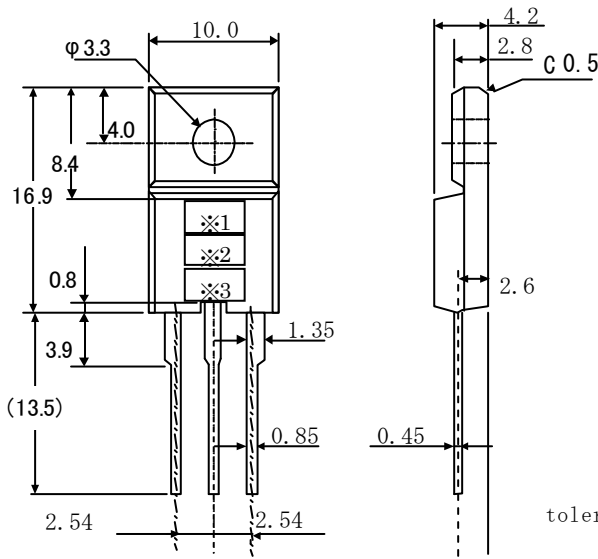

Internal layout

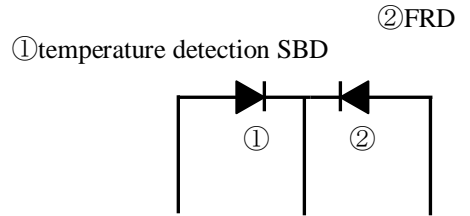

Dimensions in mm

9-2 Appearance

The body shall be clean and shall not bear any stain, rust or flaw.

9-3 Marking

Type Name	Marking		
	*1 is type name	*2 is polarity	*3 is lot number
FMKS-2102	KS2102		1st letter: Last digit of year 2nd letter: Month From 1 to 9 for Jan. to Sep., O for Oct., N for Nov., D for Dec. 3rd & 4th letter: Day ex. 2117 (Jan. 17, 2002)