



## WBFBP-06C Plastic-Encapsulate Transistors

### FMMDT5451 TRANSISTOR

#### DESCRIPTION

PNP and NPN Epitaxial Silicon Transistor

#### FEATURES

- Complementary Pair
- One 5551-Type NPN, One 5401-Type PNP
- Ultra-Small Surface Mount Package

#### APPLICATION

Ideal for Medium Power Amplification and Switching  
For portable equipment:(i.e. Mobile phone,MP3, MD,CD-ROM, DVD-ROM, Note book PC, etc.)

#### MARKING: KNM

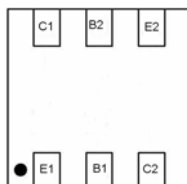
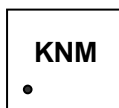

E1,B1,C1=NPN 5551 Section

E2,B2,C2=PNP 5401 Section

#### WBFBP-06C

(2×2×0.5)

unit: mm

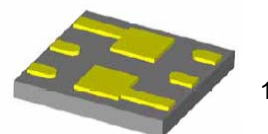

1

#### 5551 MAXIMUM RATINGS\* T<sub>A</sub>=25°C unless otherwise noted

Symbol	Parameter	Value	Units
V <sub>CB0</sub>	Collector-Base Voltage	180	V
V <sub>CEO</sub>	Collector-Emitter Voltage	160	V
V <sub>EBO</sub>	Emitter-Base Voltage	6	V
I <sub>c</sub>	Collector Current -Continuous	0.2	A
P <sub>c</sub>	Collector Dissipation	0.15	W
R <sub>θJA</sub>	Thermal Resistance, Junction to Ambient	625	K/W
T <sub>J</sub>	Junction Temperature	150	°C
T <sub>stg</sub>	Storage Temperature range	-55-150	°C

#### 5401 MAXIMUM RATINGS\* T<sub>A</sub>=25°C unless otherwise noted

Symbol	Parameter	Value	Units
V <sub>CB0</sub>	Collector- Base Voltage	-160	V
V <sub>CEO</sub>	Collector-Emitter Voltage	-150	V
V <sub>EBO</sub>	Emitter-Base Voltage	-5	V
I <sub>c</sub>	Collector Current -Continuous	-0.2	A
P <sub>c</sub>	Collector Dissipation	0.15	W
R <sub>θJA</sub>	Thermal Resistance, Junction to Ambient	625	K/W
T <sub>J</sub>	Junction Temperature	150	°C
T <sub>stg</sub>	Storage Temperature range	-55-150	°C

**5551 ELECTRICAL CHARACTERISTICS (Tamb=25°C unless otherwise specified)**

Parameter	Symbol	Test conditions	MIN	TYP	MAX	UNIT
Collector-base breakdown voltage	$V_{(BR)CBO}$	$I_C=100\mu A, I_E=0$	180			V
Collector-emitter breakdown voltage	$V_{(BR)CEO}$	$I_C=1mA, I_B=0$	160			V
Emitter-base breakdown voltage	$V_{(BR)EBO}$	$I_E=10\mu A, I_C=0$	6			V
Collector cut-off current	$I_{CBO}$	$V_{CB}=120V, I_E=0$			50	nA
Emitter cut-off current	$I_{EBO}$	$V_{EB}=4V, I_C=0$			50	nA
DC current gain	$h_{FE(1)}$	$V_{CE}=5V, I_C=1mA$	80			
	$h_{FE(2)}$	$V_{CE}=5V, I_C=10mA$	80		250	
	$h_{FE(3)}$	$V_{CE}=5V, I_C=50mA$	30			
Collector-emitter saturation voltage	$V_{CEsat}$	$I_C=10mA, I_B=1mA$			0.15	V
		$I_C=50mA, I_B=5mA$			0.2	
Base-emitter saturation voltage	$V_{BEsat}$	$I_C=10mA, I_B=1mA$			1	V
		$I_C=50mA, I_B=5mA$			1	
Transition frequency	$f_T$	$V_{CE}=10V, I_C=10mA, f=100MHz$	100		300	MHz
Collector output capacitance	$C_{ob}$	$V_{CB}=10V, I_E=0, f=1MHz$			6	pF
Noise figure	NF	$V_{CE}=5V, I_C=0.2mA, f=1KHz, R_g=1k\Omega$			8	dB

**5401 ELECTRICAL CHARACTERISTICS (Tamb=25°C unless otherwise specified)**

Parameter	Symbol	Test conditions	MIN	TYP	MAX	UNIT
Collector-base breakdown voltage	$V_{(BR)CBO}$	$I_C=-100\mu A, I_E=0$	-160			V
Collector-emitter breakdown voltage	$V_{(BR)CEO}$	$I_C=-1mA, I_B=0$	-150			V
Emitter-base breakdown voltage	$V_{(BR)EBO}$	$I_E=-10\mu A, I_C=0$	-5			V
Collector cut-off current	$I_{CBO}$	$V_{CB}=-120V, I_E=0$			-0.05	$\mu A$
Emitter cut-off current	$I_{EBO}$	$V_{EB}=-3V, I_C=0$			-0.05	$\mu A$
DC current gain	$h_{FE(1)}$	$V_{CE}=-5V, I_C=-1mA$	50			
	$h_{FE(2)}$	$V_{CE}=-5V, I_C=-10mA$	60		240	
	$h_{FE(3)}$	$V_{CE}=-5V, I_C=-50mA$	50			
Collector-emitter saturation voltage	$V_{CE(sat)1}$	$I_C=-10mA, I_B=-1mA$			-0.2	V
	$V_{CE(sat)2}$	$I_C=-50mA, I_B=-5mA$			-0.5	V
Base-emitter saturation voltage	$V_{BE(sat)1}$	$I_C=-10mA, I_B=-1mA$			-1	V
	$V_{BE(sat)2}$	$I_C=-50mA, I_B=-5mA$			-1	V
Transition frequency	$f_T$	$V_{CE}=-10V, I_C=-10mA, f=100MHz$	100		300	MHz
Output Capacitance	$C_{ob}$	$V_{CB}=-10V, I_E=0, f=1MHz$			6	pF
Noise Figure	NF	$V_{CE}=-5.0V, I_C=-200\mu A, R_S=10\Omega, f=1.0kHz$			8.0	dB

# Typical Characteristics

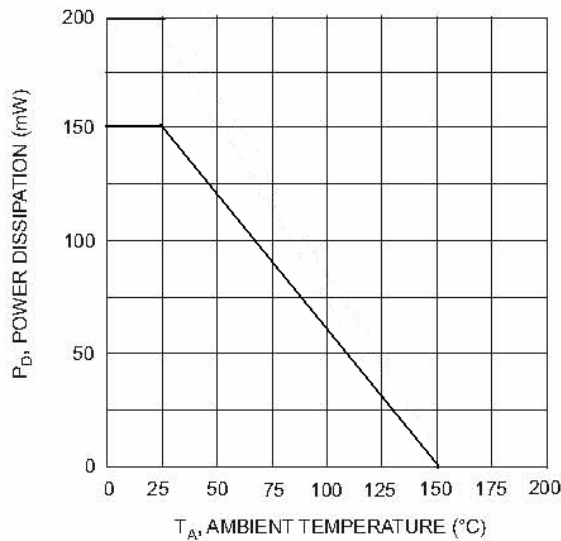

$T_A$ , AMBIENT TEMPERATURE ( $^{\circ}C$ )  
Fig. 1, Max Power Dissipation vs Ambient Temperature (Total Device)

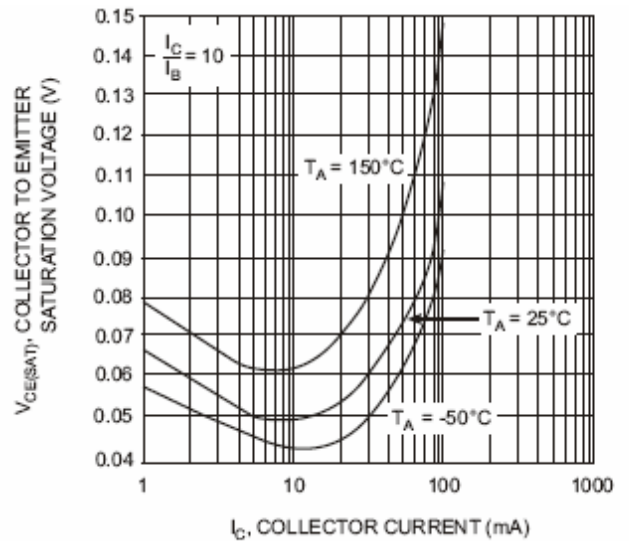

$I_C$ , COLLECTOR CURRENT (mA)  
Fig. 2, Collector Emitter Saturation Voltage vs. Collector Current (NPN5551)

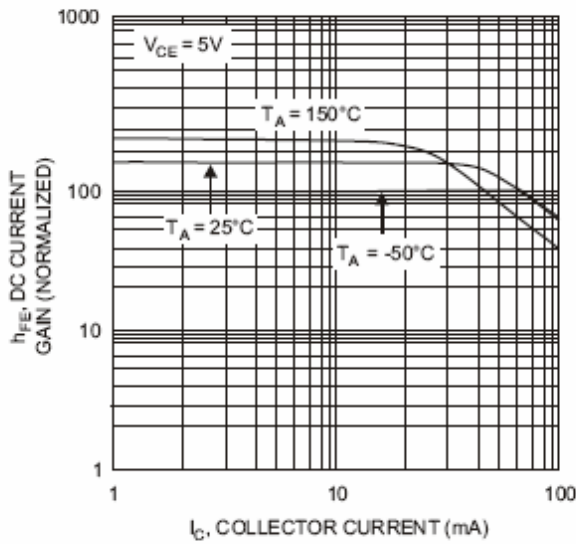

$I_C$ , COLLECTOR CURRENT (mA)  
Fig. 3, DC Current Gain vs Collector Current (NPN5551)

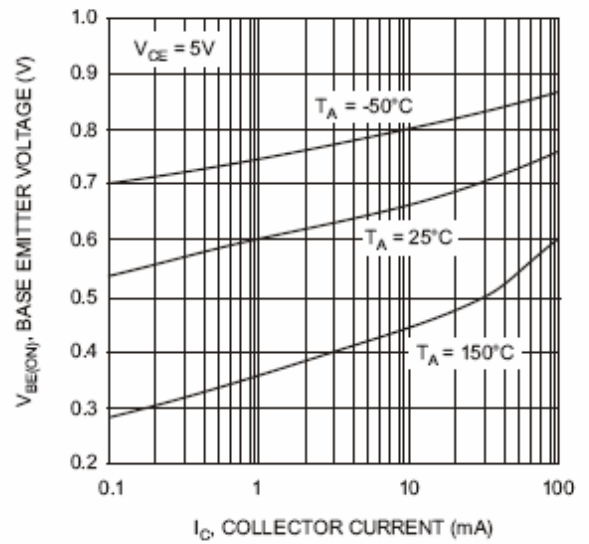

$I_C$ , COLLECTOR CURRENT (mA)  
Fig. 4, Base Emitter Voltage vs. Collector Current (NPN5551)

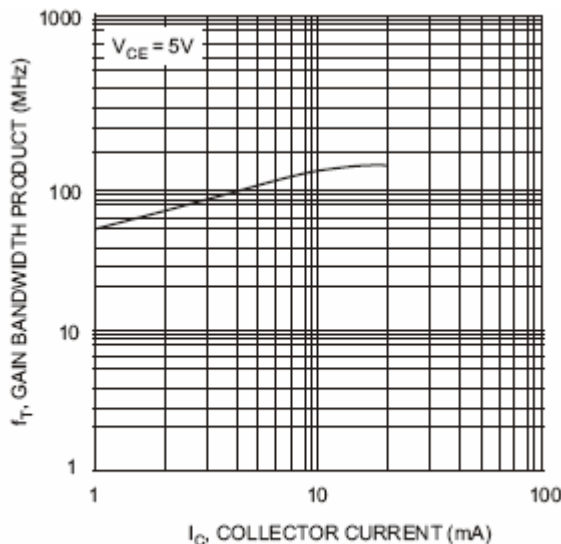

$I_C$ , COLLECTOR CURRENT (mA)  
Fig. 5, Gain Bandwidth Product vs. Collector Current (NPN5551)

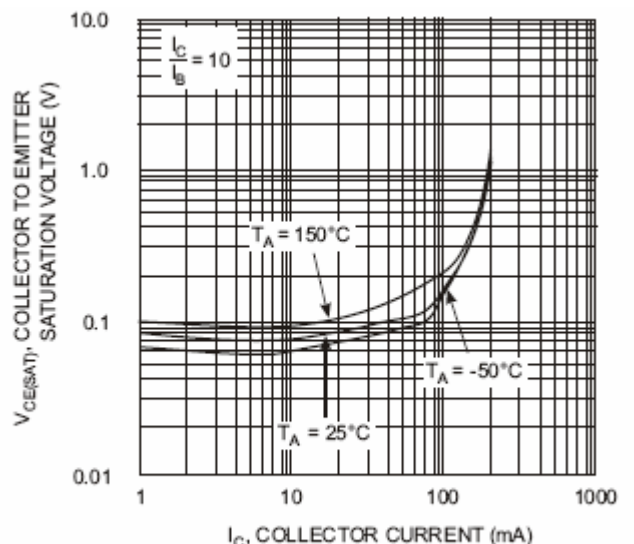

$I_C$ , COLLECTOR CURRENT (mA)  
Fig. 6, Collector Emitter Saturation Voltage vs. Collector Current (PNP5401)

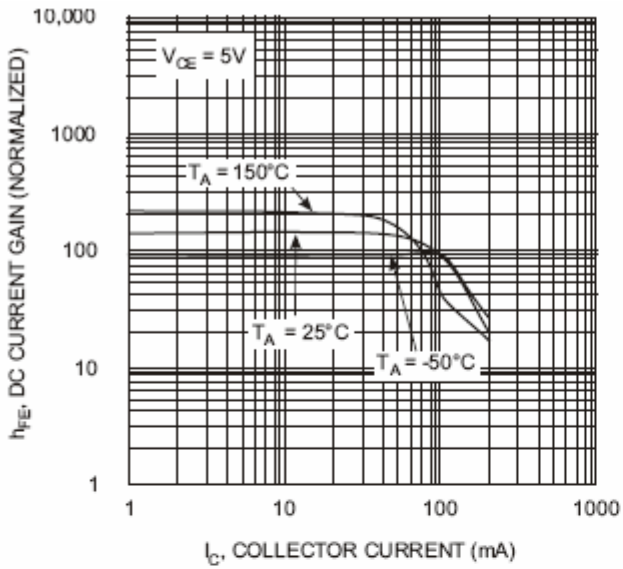

Fig. 7, DC Current Gain vs. Collector Current (PNP5401)

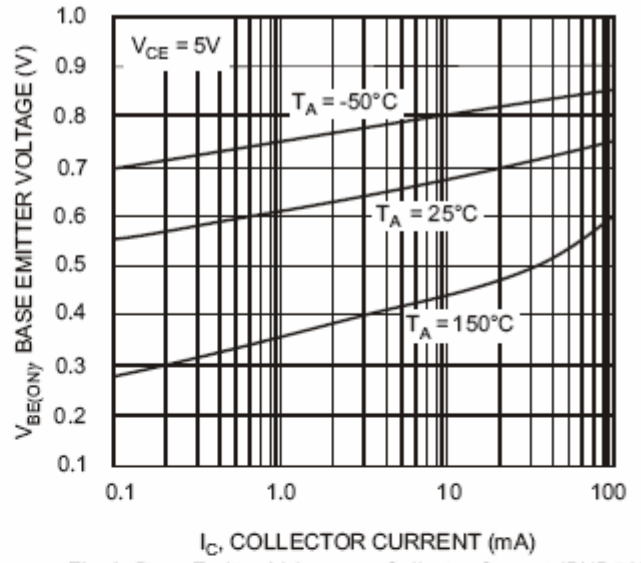

Fig. 8, Base Emitter Voltage vs. Collector Current (PNP5401)

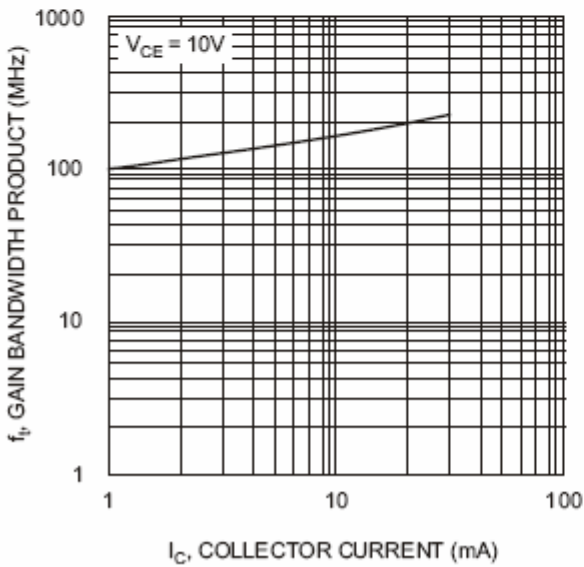
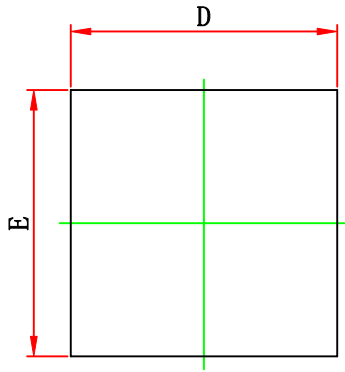

Fig. 9, Gain Bandwidth Product vs. Collector Current (PNP5401)



### WBFBP-06C(2×2×0.5) PACKAGE OUTLINE DIMENSIONS



TOP VIEW

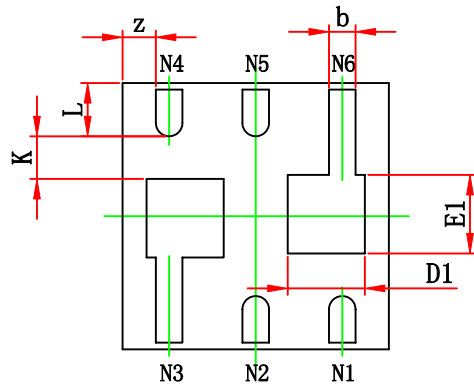

BOTTOM VIEW

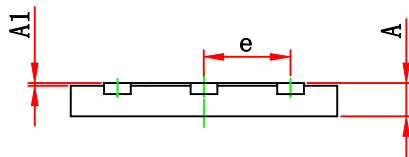

SIDE VIEW

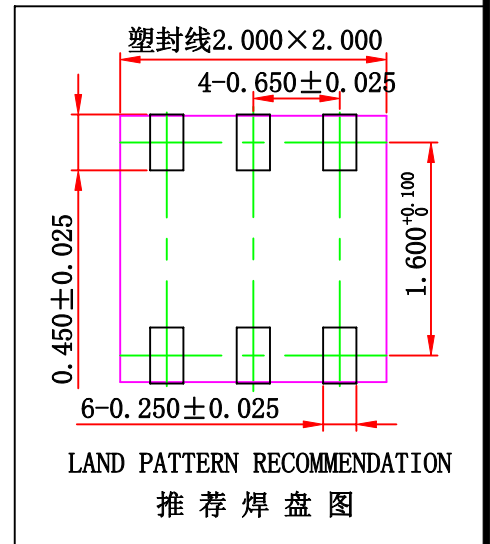

Symbol	Dimensions In Millimeters		Dimensions In Inches	
	Min.	Max.	Min.	Max.
A	0.450	0.550	0.018	0.022
A1	0.000	0.100	0.000	0.004
b	0.150	0.250	0.006	0.010
D	1.900	2.100	0.075	0.083
E	1.900	2.100	0.075	0.083
D1	0.590 REF.		0.023 REF.	
E1	0.590 REF.		0.023 REF.	
e	0.650 TYP.		0.026 TYP.	
L	0.400 REF.		0.016 REF.	
k	0.300 REF.		0.012 REF.	
z	0.500 REF.		0.020 REF.	

# APPLICATION CIRTCUITS

