

Damper Diodes (For Display)

Parameter Type No.	Absolute Maximum Ratings					Electrical Characteristics (Ta=25°C)							Others					
	V _{RM} (V)	I _{F(AV)} (A)	I _{FSM} (A) 50Hz Half-cycle Sinewave Single Shot	T _J (°C)	T _{stg} (°C)	V _F (V)		I _R (μA)	I _R (H) (μA) V _R =V _{RM} Ta=100°C max	t _{rr} (1) (μs)	t _{rr} (2) (μs)	R _{th(j-ℓ)} (°C/W)	Mass (g)	Fig.	Remarks			
						max	I _F (A)									I _F /I _{RP} (mA)	I _F /I _{RP} (mA)	
FMP-G2FS	1500	5.0	50	-40 to +150		2.0	5.0	50	500 (T _J =150°C)	0.7	500/500	0.3	4.0	2.1	Ⓐ			
FMQ-G2FLS						1.8											1.2	
FMQ-G2FS						2.8												
FMQ-G5FMS		10.0				2.4											0.5	
FMQ-G5GS	1700					2.7		100				2.0	6.5	Ⓑ				
FMP-G5HS	1800	8.0				2.0	8.0		25			0.4						
RG 2A2	1300	0.5	5	-40 to +150		3.5	0.5	100	500	0.1	100/100	0.05	12.0	0.6	Ⓒ	For Compensation		
RC 3B2	1600	1.0	20			3.6	1.0										0.07	500/500

FMP-G2FS

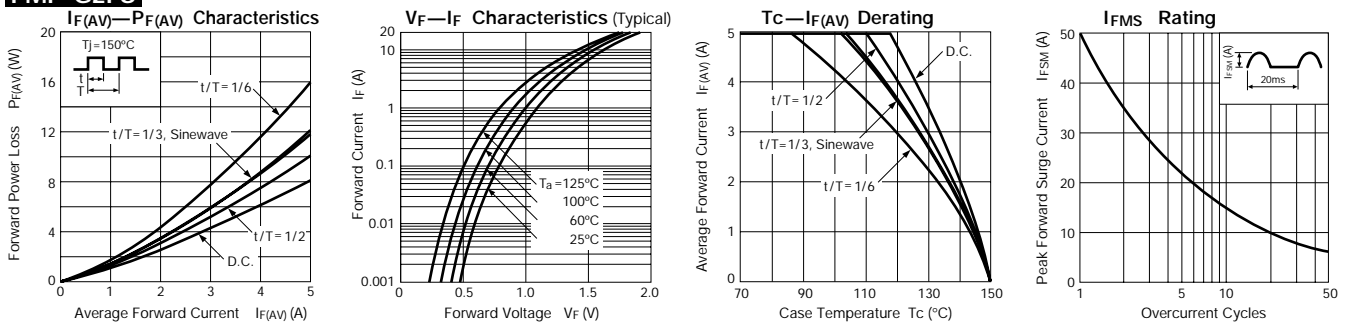

FMQ-G2FLS

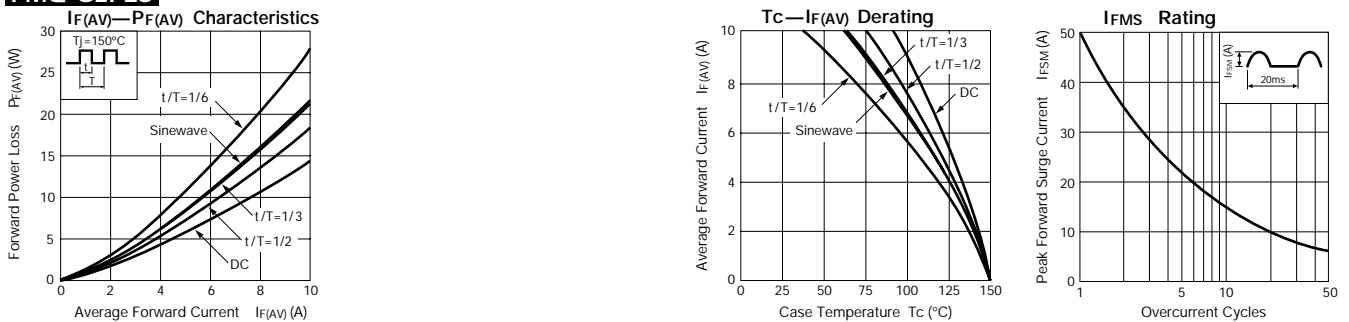

FMQ-G2FS

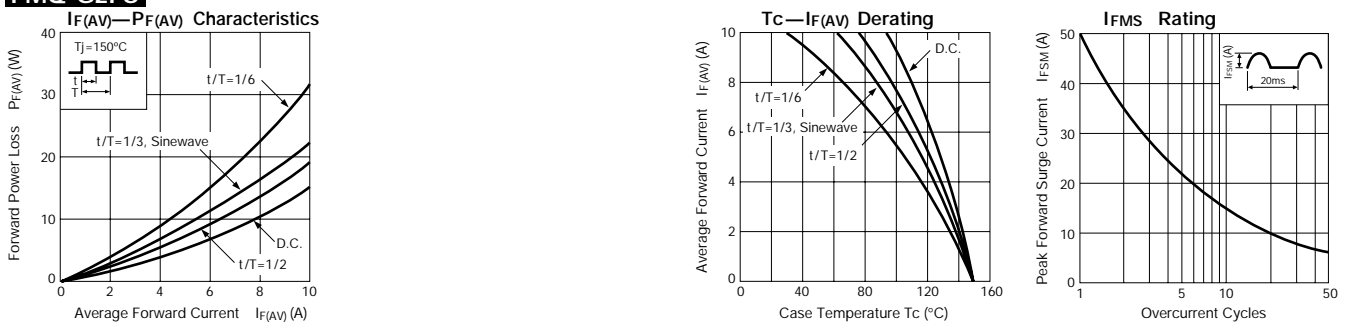

External Dimensions

(Unit: mm) (Full-mold)

Flammability:
UL94V-0 or Equivalent

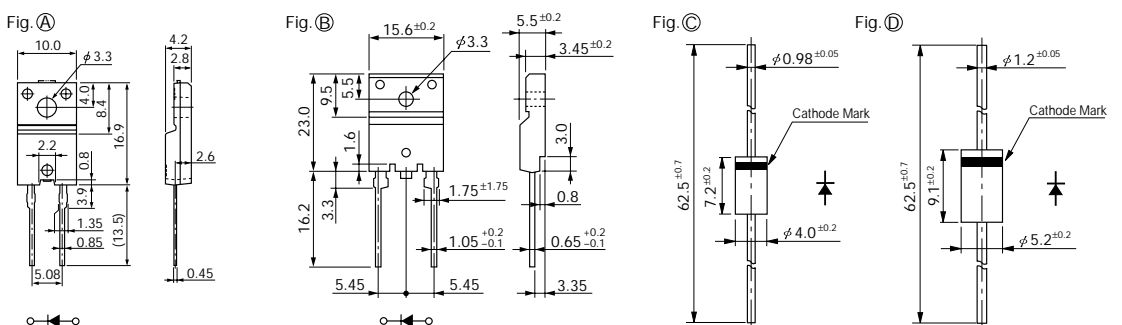

FMQ-G5FMS

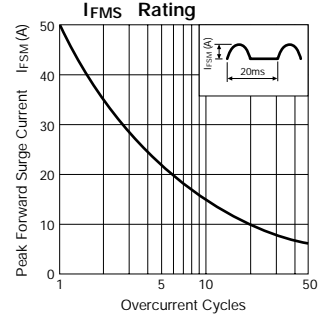
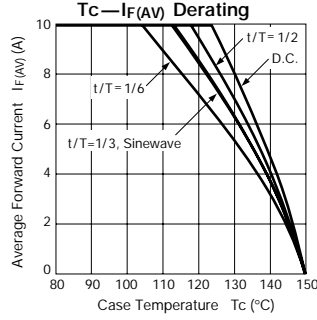
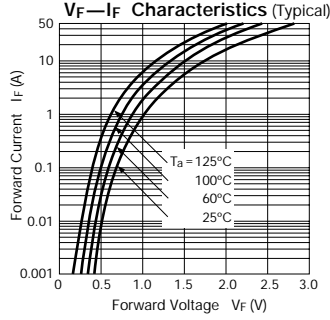
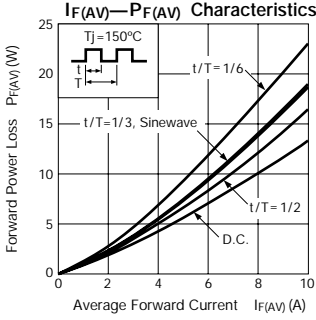

FMQ-G5GS

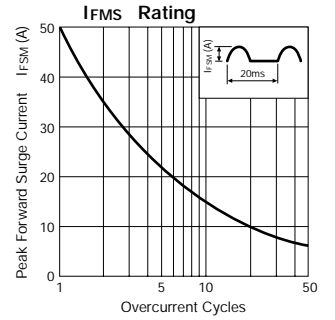
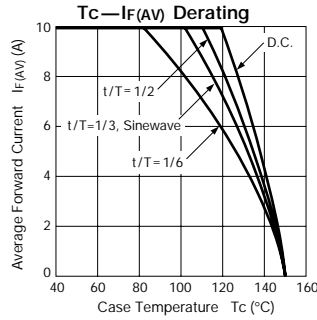
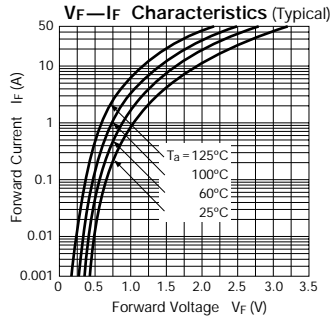
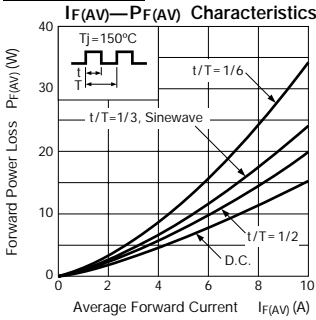

FMP-G5HS

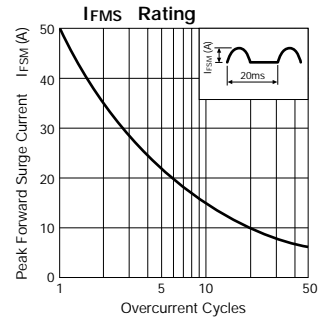
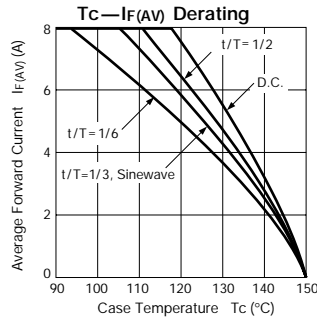
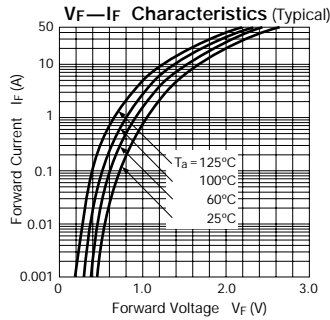
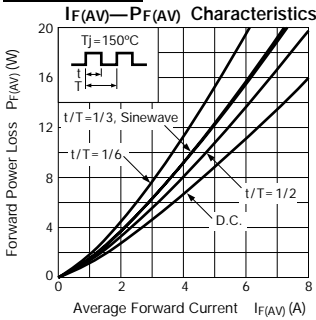

RG 2A2

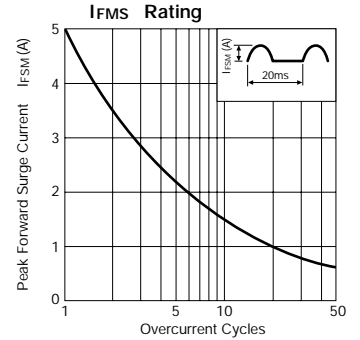
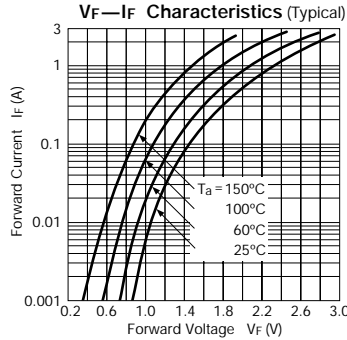
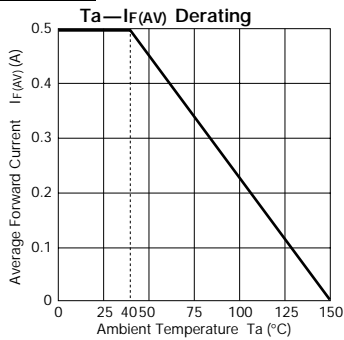

RC 3B2

