

# FMP20N50E

FUJI POWER MOSFET

## Super FAP-E<sup>3</sup> series

## N-CHANNEL SILICON POWER MOSFET

### Features

- Maintains both low power loss and low noise
- Lower  $R_{DS(on)}$  characteristic
- More controllable switching  $dv/dt$  by gate resistance
- Smaller  $V_{GS}$  ringing waveform during switching
- Narrow band of the gate threshold voltage ( $3.0 \pm 0.5V$ )
- High avalanche durability

### Applications

- Switching regulators
- UPS (Uninterruptible Power Supply)
- DC-DC converters

### Outline Drawings [mm]

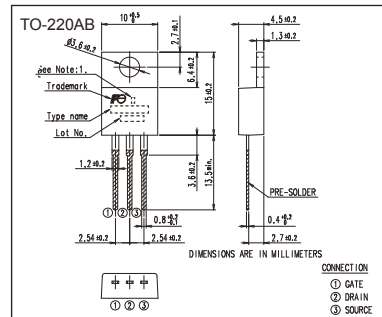

### Equivalent circuit schematic

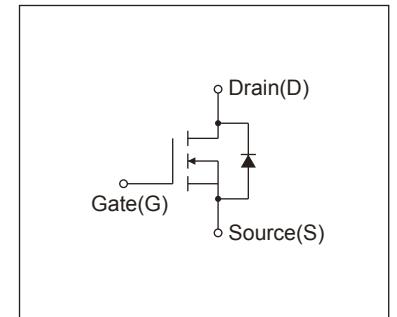

### Maximum Ratings and Characteristics

#### Absolute Maximum Ratings at $T_c=25^\circ C$ (unless otherwise specified)

Description	Symbol	Characteristics	Unit	Remarks
Drain-Source Voltage	$V_{DS}$	500	V	
	$V_{DSX}$	500	V	$V_{GS} = -30V$
Continuous Drain Current	$I_D$	$\pm 20$	A	
Pulsed Drain Current	$I_{DP}$	$\pm 80$	A	
Gate-Source Voltage	$V_{GS}$	$\pm 30$	V	
Repetitive and Non-Repetitive Maximum Avalanche Current	$I_{AR}$	20	A	Note*1
Non-Repetitive Maximum Avalanche Energy	$E_{AS}$	582.5	mJ	Note*2
Repetitive Maximum Avalanche Energy	$E_{AR}$	27	mJ	Note*3
Peak Diode Recovery $dV/dt$	$dV/dt$	7.4	kV/ $\mu s$	Note*4
Peak Diode Recovery $-di/dt$	$-di/dt$	100	A/ $\mu s$	Note*5
Maximum Power Dissipation	$P_D$	2.16	W	$T_a=25^\circ C$
		270		$T_c=25^\circ C$
Operating and Storage Temperature range	$T_{ch}$	150	$^\circ C$	
	$T_{stg}$	-55 to +150	$^\circ C$	

#### Electrical Characteristics at $T_c=25^\circ C$ (unless otherwise specified)

Description	Symbol	Conditions	min.	typ.	max.	Unit
Drain-Source Breakdown Voltage	$BV_{DSS}$	$I_D=250\mu A, V_{GS}=0V$	500	-	-	V
Gate Threshold Voltage	$V_{GS(th)}$	$I_D=250\mu A, V_{DS}=V_{GS}$	2.5	3.0	3.5	V
Zero Gate Voltage Drain Current	$I_{DSS}$	$V_{DS}=500V, V_{GS}=0V$	-	-	25	$\mu A$
		$V_{DS}=400V, V_{GS}=0V$	-	-	250	
Gate-Source Leakage Current	$I_{GSS}$	$V_{GS}=\pm 30V, V_{DS}=0V$	-	10	100	nA
Drain-Source On-State Resistance	$R_{DS(on)}$	$I_D=10A, V_{GS}=10V$	-	0.27	0.31	$\Omega$
Forward Transconductance	$g_{fs}$	$I_D=10A, V_{DS}=25V$	11	22	-	S
Input Capacitance	$C_{iss}$	$V_{DS}=25V$	-	2650	3980	pF
Output Capacitance	$C_{oss}$	$V_{GS}=0V$	-	250	375	
Reverse Transfer Capacitance	$C_{rss}$	$f=1MHz$	-	19	28.5	
Turn-On Time	$t_{d(on)}$	$V_{cc}=300V$	-	22	33	ns
	$t_r$	$V_{GS}=10V$	-	11	16.5	
Turn-Off Time	$t_{d(off)}$	$I_D=10A$	-	120	180	
	$t_f$	$R_{GS}=10\Omega$	-	21	31.5	
Total Gate Charge	$Q_G$	$V_{cc}=250V$	-	77	115.5	nC
Gate-Source Charge	$Q_{GS}$	$I_D=20A$	-	17	25.5	
Gate-Drain Charge	$Q_{GD}$	$V_{GS}=10V$	-	22	33	
Avalanche Capability	$I_{AV}$	$L=1.07mH, T_{ch}=25^\circ C$	20	-	-	A
Diode Forward On-Voltage	$V_{SD}$	$I_F=20A, V_{GS}=0V, T_{ch}=25^\circ C$	-	0.90	1.35	V
Reverse Recovery Time	$t_{rr}$	$I_F=20A, V_{GS}=0V$	-	0.5	-	$\mu s$
Reverse Recovery Charge	$Q_{rr}$	$-di/dt=100A/\mu s, T_{ch}=25^\circ C$	-	7	-	$\mu C$

#### Thermal Characteristics

Description	Symbol	Test Conditions	min.	typ.	max.	Unit
Thermal resistance	$R_{th(ch-c)}$	Channel to Case			0.460	$^\circ C/W$
	$R_{th(ch-a)}$	Channel to Ambient			62.0	$^\circ C/W$

Note \*1 :  $T_{ch} \leq 150^\circ C$

Note \*2 : Stating  $T_{ch}=25^\circ C, I_{AS}=8A, L=16.7mH, V_{cc}=50V, R_G=50\Omega$

$E_{AS}$  limited by maximum channel temperature and avalanche current.  
See to 'Avalanche Energy' graph.

Note \*3 : Repetitive rating : Pulse width limited by maximum channel temperature.

See to the 'Transient Thermal Impedance' graph.

Note \*4 :  $I_F \leq I_D, -di/dt=100A/\mu s, V_{cc} \leq BV_{DSS}, T_{ch} \leq 150^\circ C$ .

Note \*5 :  $I_F \leq I_D, dv/dt=7.4kV/\mu s, V_{cc} \leq BV_{DSS}, T_{ch} \leq 150^\circ C$ .

Allowable Power Dissipation  
 $PD=f(T_c)$

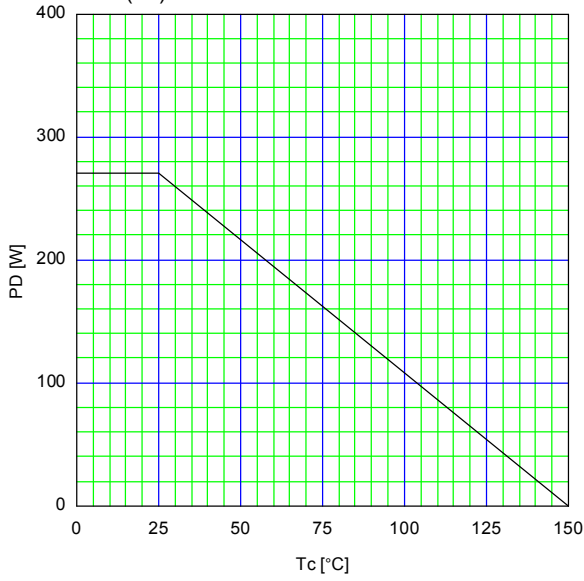

Safe Operating Area  
 $I_D=f(V_{DS}):Duty=0(\text{Single pulse}),T_c=25^\circ\text{C}$

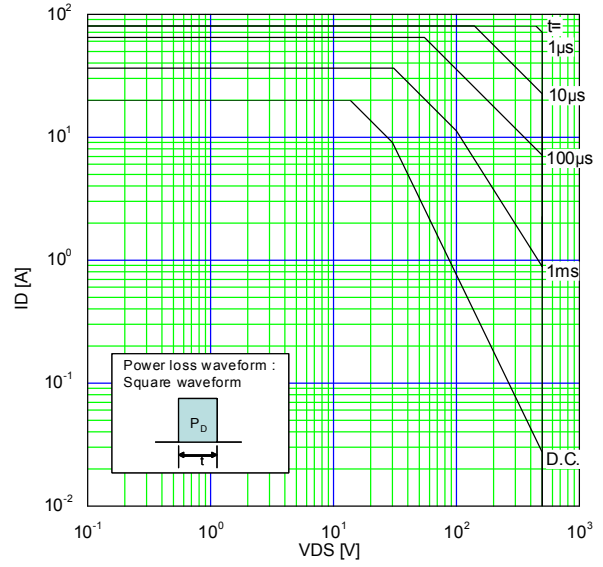

Typical Output Characteristics  
 $I_D=f(V_{DS}):80\ \mu\text{s pulse test},T_{ch}=25^\circ\text{C}$

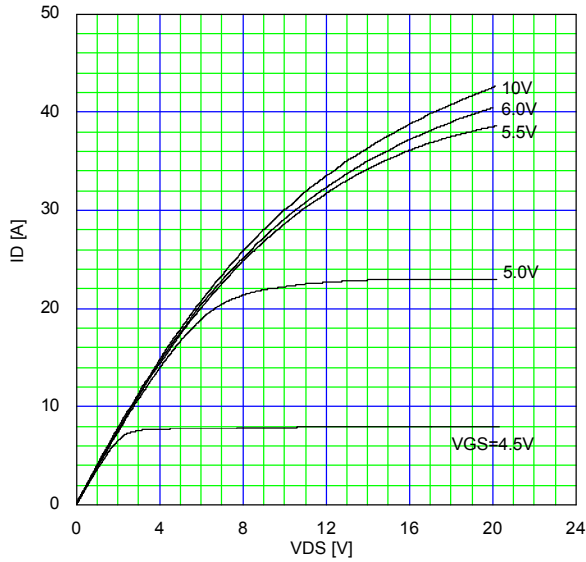

Typical Transfer Characteristic  
 $I_D=f(V_{GS}):80\ \mu\text{s pulse test},V_{DS}=25\text{V},T_{ch}=25^\circ\text{C}$

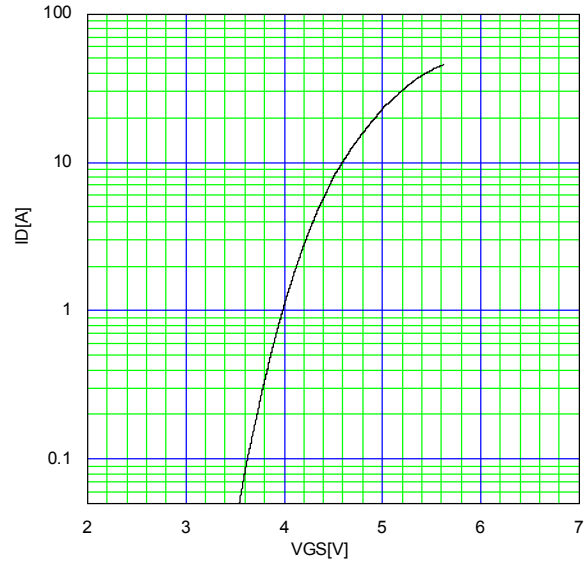

Typical Transconductance  
 $g_{fs}=f(I_D):80\ \mu\text{s pulse test},V_{DS}=25\text{V},T_{ch}=25^\circ\text{C}$

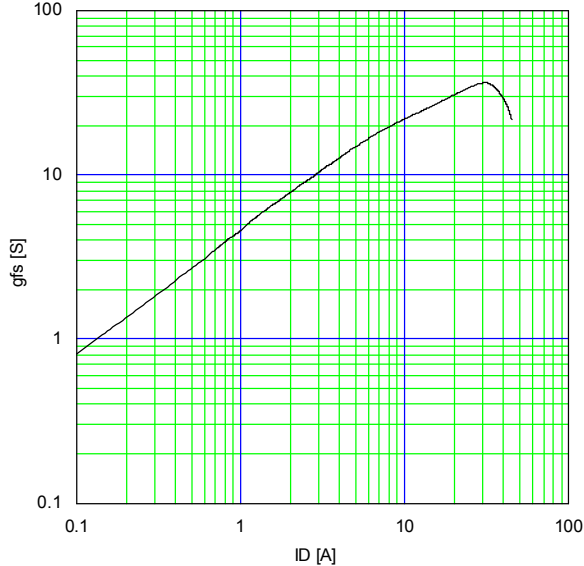

Typical Drain-Source on-state Resistance  
 $R_{DS(on)}=f(I_D):80\ \mu\text{s pulse test},T_{ch}=25^\circ\text{C}$

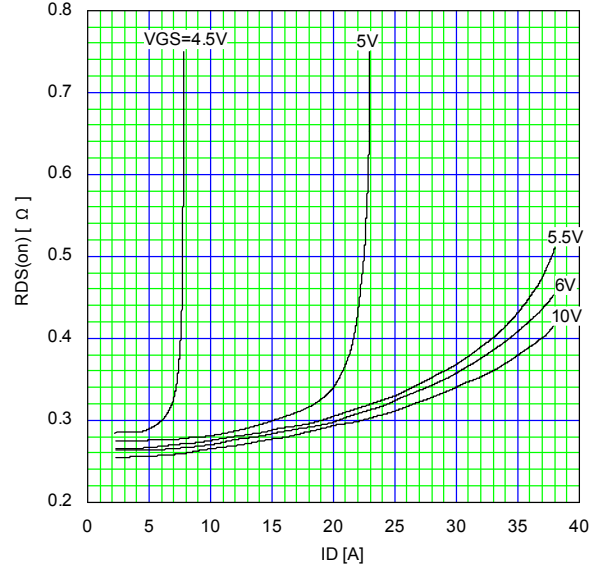

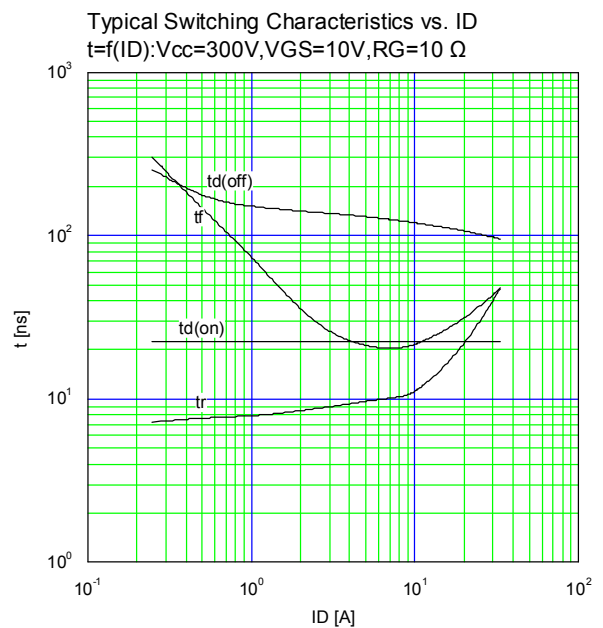
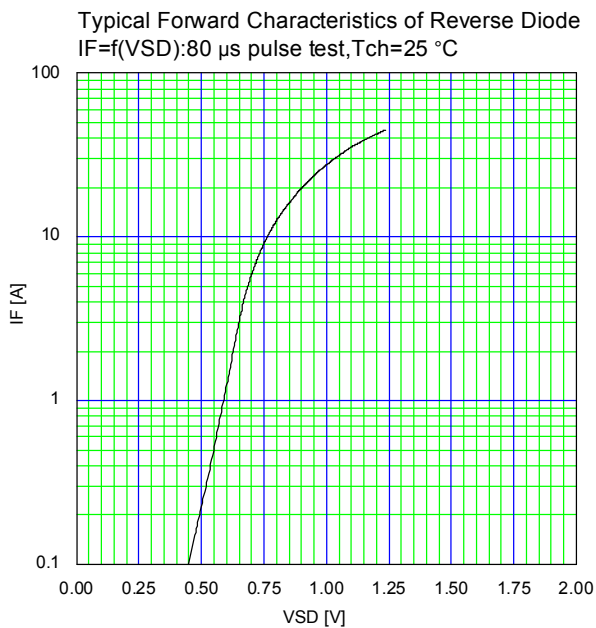
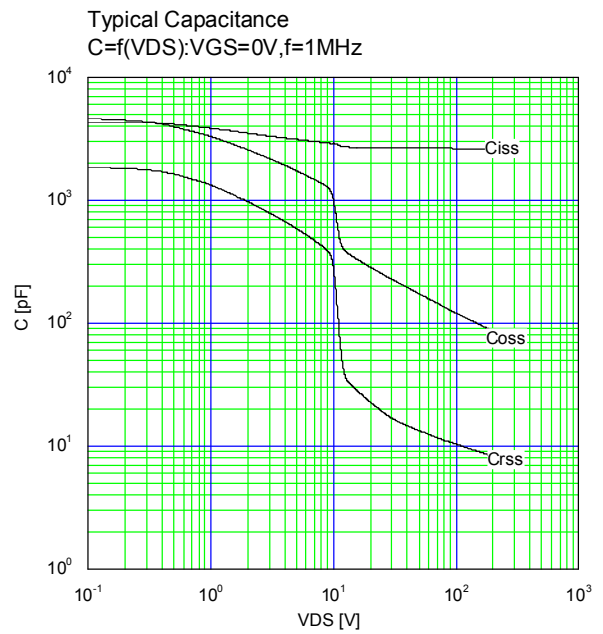
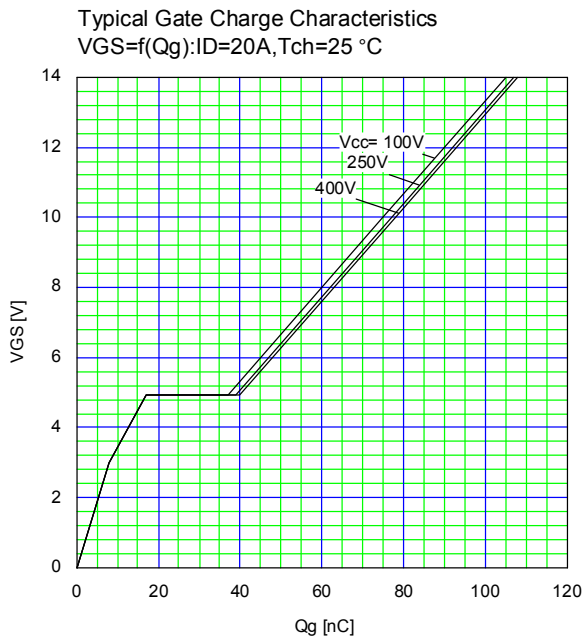
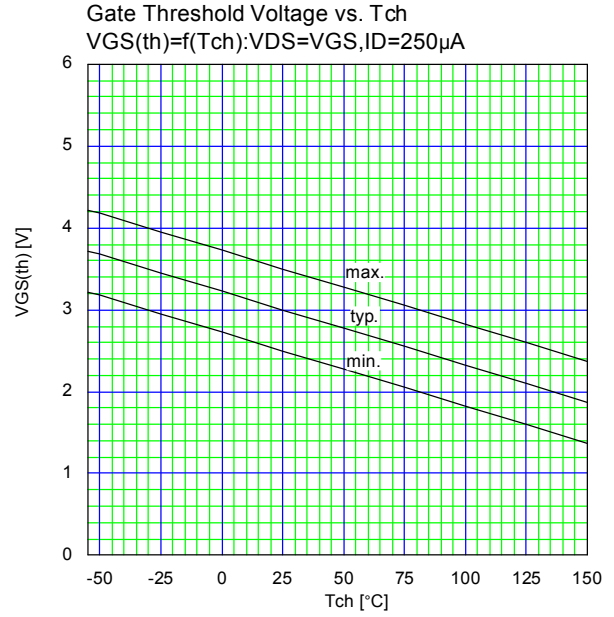
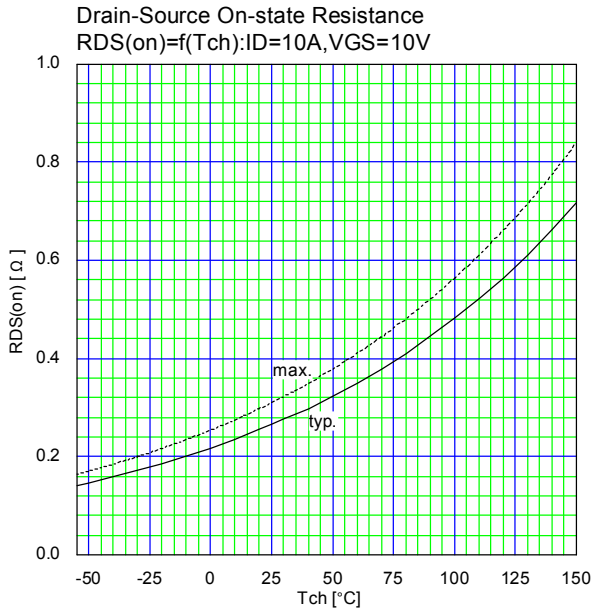

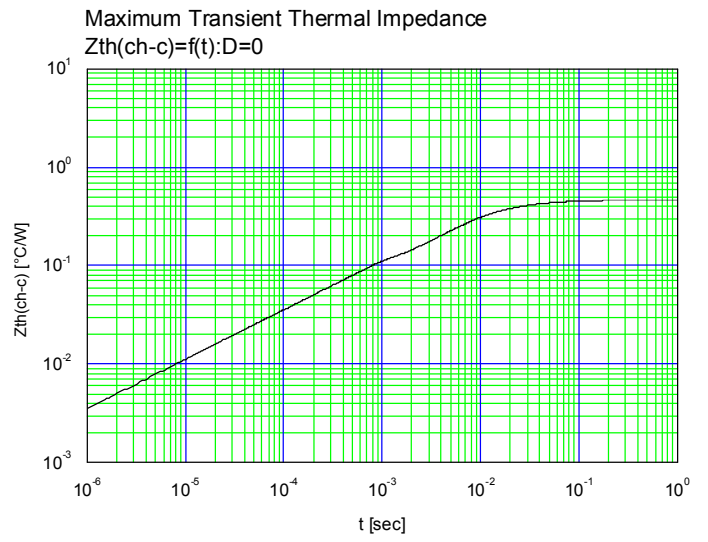
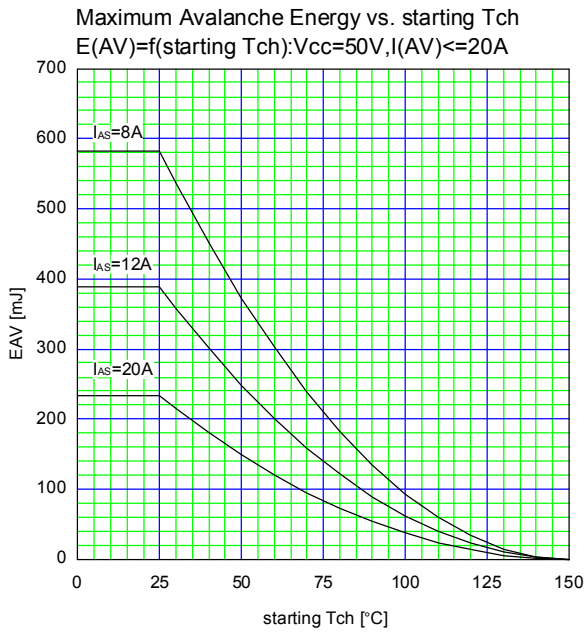

**WARNING**

1. This Catalog contains the product specifications, characteristics, data, materials, and structures as of October 2008. The contents are subject to change without notice for specification changes or other reasons. When using a product listed in this Catalog, be sure to obtain the latest specifications.
2. All applications described in this Catalog exemplify the use of Fuji's products for your reference only. No right or license, either express or implied, under any patent, copyright, trade secret or other intellectual property right owned by Fuji Electric Device Technology Co., Ltd. is (or shall be deemed) granted. Fuji Electric Device Technology Co., Ltd. makes no representation or warranty, whether express or implied, relating to the infringement or alleged infringement of other's intellectual property rights which may arise from the use of the applications described herein.
3. Although Fuji Electric Device Technology Co., Ltd. is enhancing product quality and reliability, a small percentage of semiconductor products may become faulty. When using Fuji Electric semiconductor products in your equipment, you are requested to take adequate safety measures to prevent the equipment from causing a physical injury, fire, or other problem if any of the products become faulty. It is recommended to make your design fail-safe, flame retardant, and free of malfunction.
4. The products introduced in this Catalog are intended for use in the following electronic and electrical equipment which has normal reliability requirements.
  - Computers                      • OA equipment                      • Communications equipment (terminal devices)                      • Measurement equipment
  - Machine tools                      • Audiovisual equipment                      • Electrical home appliances                      • Personal equipment                      • Industrial robots etc.
5. If you need to use a product in this Catalog for equipment requiring higher reliability than normal, such as for the equipment listed below, it is imperative to contact Fuji Electric Device Technology Co., Ltd. to obtain prior approval. When using these products for such equipment, take adequate measures such as a backup system to prevent the equipment from malfunctioning even if a Fuji's product incorporated in the equipment becomes faulty.
  - Transportation equipment (mounted on cars and ships)                      • Trunk communications equipment
  - Traffic-signal control equipment                      • Gas leakage detectors with an auto-shut-off feature
  - Emergency equipment for responding to disasters and anti-burglary devices                      • Safety devices
  - Medical equipment
6. Do not use products in this Catalog for the equipment requiring strict reliability such as the following and equivalents to strategic equipment (without limitation).
  - Space equipment                      • Aeronautic equipment                      • Nuclear control equipment
  - Submarine repeater equipment
7. Copyright ©1996-2008 by Fuji Electric Device Technology Co., Ltd. All rights reserved. No part of this Catalog may be reproduced in any form or by any means without the express permission of Fuji Electric Device Technology Co., Ltd.
8. If you have any question about any portion in this Catalog, ask Fuji Electric Device Technology Co., Ltd. or its sales agents before using the product. Neither Fuji Electric Device Technology Co., Ltd. nor its agents shall be liable for any injury caused by any use of the products not in accordance with instructions set forth herein.