

FMS6363

Low Cost Three Channel 6th Order High Definition Video Filter Driver

Features

- Three sixth-order 30MHz (HD) filters
- Transparent input clamping
- Single video load drive (2V_{pp}, 150Ω, A_v = 6dB)
- AC or DC-coupled inputs
- AC or DC-coupled outputs
- DC-coupled outputs eliminate AC-coupling capacitors
- 5V only
- Robust 8KV ESD protection
- Lead (Pb) Free package- SOIC-8

Applications

- Cable and Satellite set top boxes
- DVD players
- HDTV
- Personal Video Recorders (PVR)
- Video On Demand (VOD)

Description

The FMS6363 Low Cost Video Filter (LCVF) is intended to replace passive LC filters and drivers with a low-cost integrated device. Three 6th order filters provide improved image quality compared to typical lower order passive solutions.

The FMS6363 may be directly driven by a DC-coupled DAC output or an AC-coupled signal. Internal diode clamps and bias circuitry may be used if AC-coupled inputs are required (see applications section for details).

The outputs can drive AC or DC-coupled single (150Ω) loads. DC-coupling the outputs removes the need for output coupling capacitors. The input DC levels will be offset approximately +280mV at the output (see applications section for details).

Block Diagram

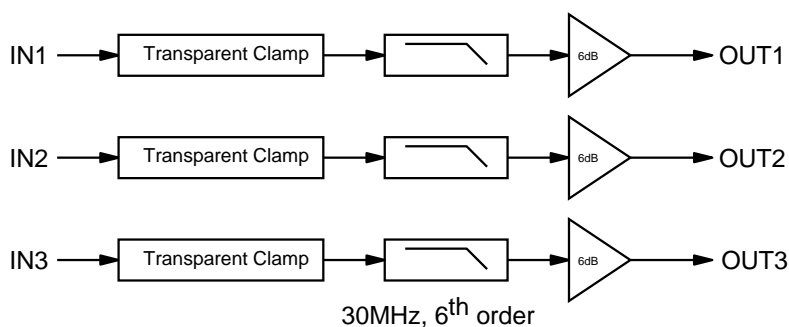

Pin Configuration

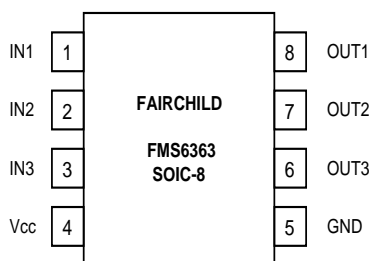

Pin Assignments

Pin#	Pin	Type	Description
1	IN1	Input	Video input, channel 1
2	IN2	Input	Video input, channel 2
3	IN3	Input	Video input, channel 3
4	VCC	Input	+5V supply
5	GND	Input	Ground
6	OUT3	Output	Filtered output, channel 3
7	OUT2	Output	Filtered output, channel 2
8	OUT1	Output	Filtered output, channel 1

Absolute Maximum Ratings

Parameter	Min.	Max.	Unit
DC Supply Voltage	-0.3	6	V
Analog and Digital I/O	-0.3	$V_{CC} + 0.3$	V
Output Current, Any One Channel (Do Not Exceed)		50	mA

Reliability Information

Parameter	Min.	Typ.	Max.	Unit
Junction Temperature			150	°C
Storage Temperature Range	-65		150	°C
Lead Temperature (Soldering, 10s)			300	°C
Thermal Resistance (θ_{JA}), JEDEC Standard, Multi-Layer Test Boards, Still Air		112.7		°C/W

Recommended Operating Conditions

Parameter	Min.	Typ.	Max.	Unit
Operating Temperature Range	0		70	°C
Supply Voltage Range	4.75	5.0	5.25	V
Input Source Resistance (R_{SOURCE})			300	Ω

DC Electrical Characteristics

$T_c = 25^\circ\text{C}$, $V_{cc} = 5\text{V}$, $R_{source} = 37.5\Omega$, inputs AC coupled with $0.1\mu\text{F}$, all outputs AC coupled with $220\mu\text{F}$ into 150Ω loads, referenced to 400kHz ; unless otherwise noted.

Symbol	Parameter	Conditions	Min.	Typ.	Max	Units
I_{CC}	Supply Current ¹	no load		22	30	mA
V_{in}	Video Input Voltage Range	Referenced to GND, if DC-coupled		1.4		Vpp

AC Electrical Characteristics

$T_c = 25^\circ\text{C}$, $V_{in} = 1V_{pp}$, $V_{cc} = 5\text{V}$, $R_{source} = 37.5\Omega$, all inputs AC coupled with $0.1\mu\text{F}$, all outputs AC coupled with $220\mu\text{F}$ into 150Ω loads, referenced to 400kHz ; unless otherwise noted.

Symbol	Parameter	Conditions	Min.	Typ.	Max	Units
AV	Channel Gain ¹	All Channels	5.4	6.0	6.6	dB
f_{1dB}	-1dB Bandwidth ¹	All Channels	23	30		MHz
f_c	-3dB Bandwidth	All Channels		33		MHz
f_{SB1}	Attenuation(stopband reject)	All Channels at $f = 37.125\text{MHz}$		6.5		dB
f_{SB2}		All Channels at $f = 44.25\text{MHz}$		14.5		dB
f_{SB3}		All Channels at $f = 74.25\text{MHz}$ ¹	32	36		dB
THD1	Output Distortion ³ (all channels)	$V_{OUT} = 1.4V_{pp}$, 10MHz		0.2		%
THD2		$V_{OUT} = 1.4V_{pp}$, 15MHz		0.4		%
THD3		$V_{OUT} = 1.4V_{pp}$, 22MHz		1.2		%
X_{TALK}	Crosstalk (ch-to-ch)	at 1MHz		-60		dB
SNR1 SNR2	Signal-to-Noise Ratio ² (all channels)	unweighted; 30MHz lowpass, 100kHz to 30MHz		65		dB
t_{pd}	Propagation Delay	Delay from input to output		20		ns

Notes:

1. 100% tested at 25°C
2. $SNR = 20 * \log(714\text{mV}/\text{rms noise})$
3. $1.4V_{pp}$ active video

Typical Performance Characteristics

$T_C = 25^\circ\text{C}$, $V_{CC} = 5\text{V}$, $R_{SOURCE} = 37.5\Omega$, inputs AC coupled with $0.1\mu\text{F}$, all outputs AC coupled with $220\mu\text{F}$ into 150Ω loads, referenced to 400kHz ; unless otherwise noted.

Figure 1. Frequency Response

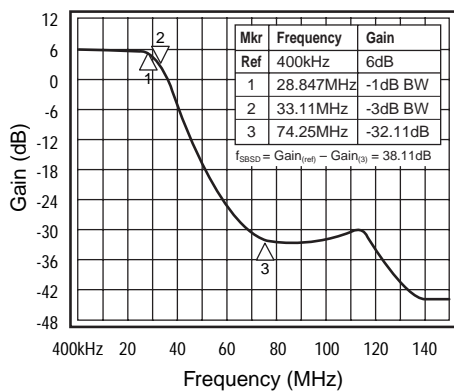

Figure 2. Group Delay vs. Frequency

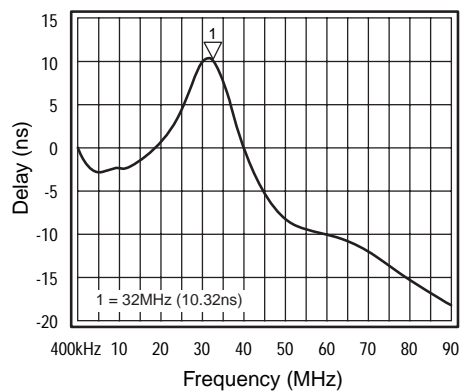

Figure 3. PSRR vs. Freq. (No Bypass Caps)

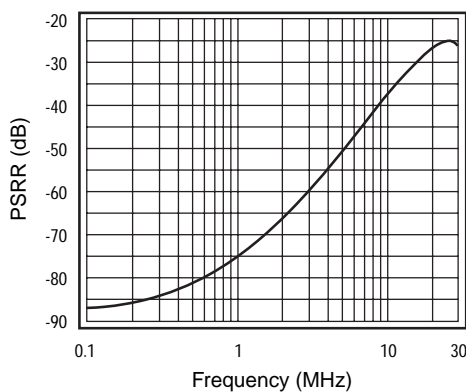

Figure 4. PSRR vs. Freq. (Bypass Caps)

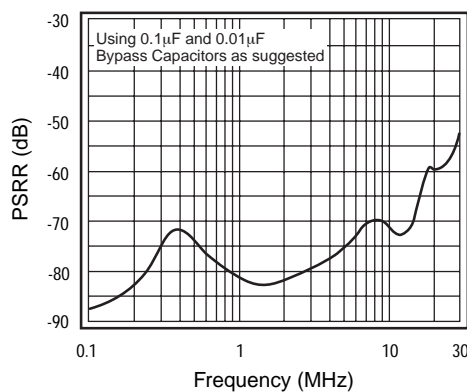
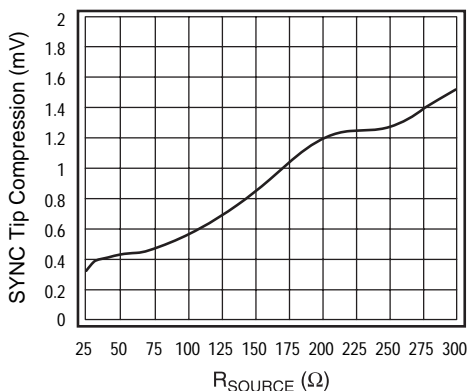

Figure 5. SYNC Tip Compression vs. R_{SOURCE}



Applications Information

Functional Description

The FMS6363 Low Cost Video Filter (LCVF) provides 6dB gain from input to output. In addition, the input will be slightly offset to optimize the output driver performance. The offset is held to the minimum required value to decrease the standing DC current into the load. Typical voltage levels are shown in the diagram below.

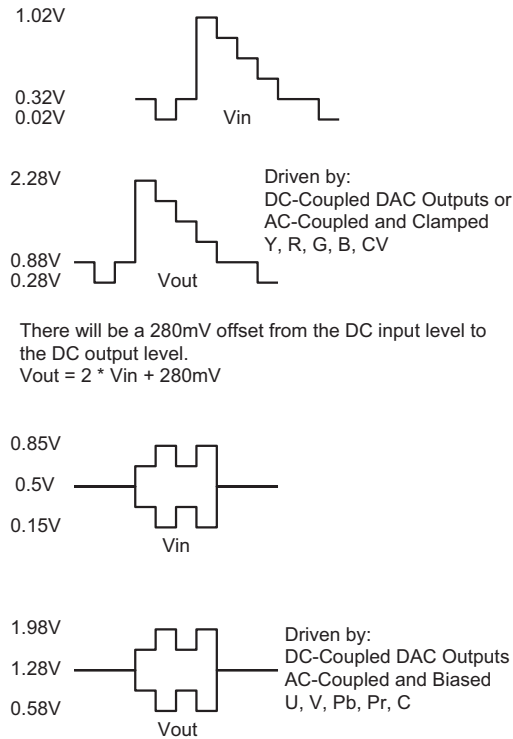

Figure 6. Typical Voltage Levels

The FMS6363 provides an internal diode clamp to support AC-coupled input signals. If the input signal does not go below ground, the input clamp will not operate. This allows DAC outputs to directly drive the FMS6363 without an AC coupling capacitor. The worst-case sync tip compression due to the clamp will not exceed 7mV. The input level set by the clamp combined with the internal DC offset will keep the output within its acceptable range. When the input is AC-coupled, the diode clamp will set the sync tip (or lowest voltage) just below ground.

For symmetric signals like C, U, V, Cb, Cr, Pb and Pr, the average DC bias is fairly constant and the inputs can be AC-coupled with the addition of a pull-up resistor to set the DC input voltage. DAC outputs can also drive these same signals without the AC

coupling capacitor. A conceptual illustration of the input clamp circuit is shown below:

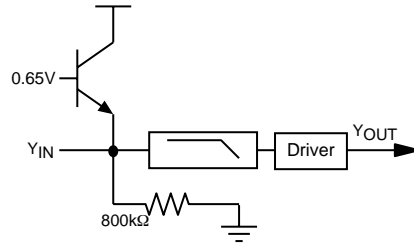

Figure 7. Input Clamp Circuit

I/O Configurations

For DC-coupled DAC drive with DC-coupled outputs, use this configuration:

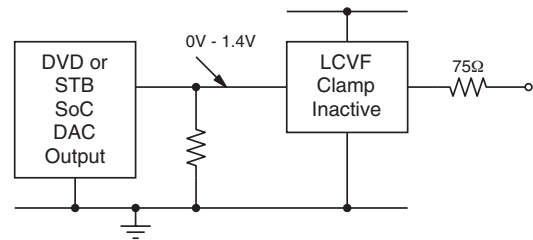

Figure 8. DC-coupled inputs and outputs

Alternatively, if the DAC's average DC output level causes the signal to exceed the range of 0V to 1.4V, it can be AC-coupled as follows:

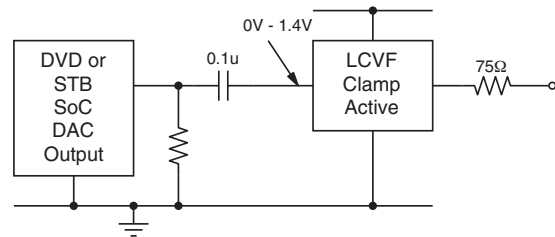

Figure 9. AC-coupled inputs, DC-coupled outputs

When the FMS6363 is driven by an unknown external source or a SCART switch with its own clamping circuitry the inputs should be AC-coupled as follows:

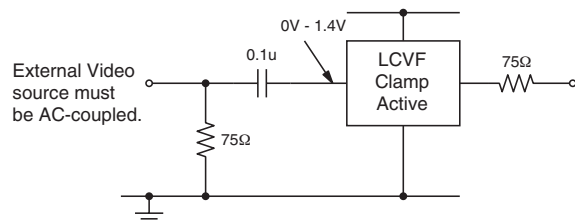

Figure 10. SCART with DC-coupled outputs

The same method can be used for biased signals with the addition of a pull-up resistor to make sure the clamp never operates. The internal pull-down resistance is $800k\Omega \pm 20\%$ so the external resistance should be $7.5M\Omega$ to set the DC level to 500mV. If a pull-up resistance less than $7.5M\Omega$ is desired, an external pull-down can be added such that the DC input level is set to 500mV.

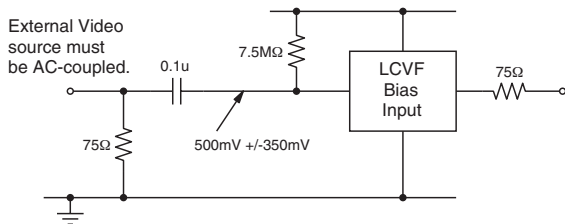

Figure 11. Biased SCART with DC-coupled outputs

The same circuits can be used with AC-coupled outputs if desired.

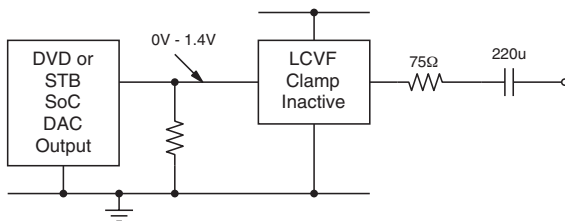

Figure 12. DC-coupled inputs, AC-coupled Outputs

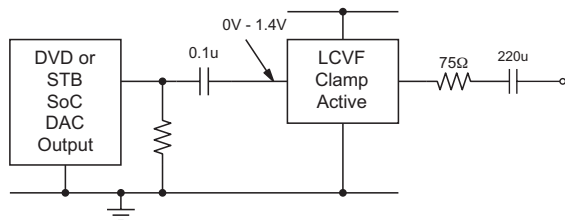

Figure 13. AC-coupled inputs and outputs

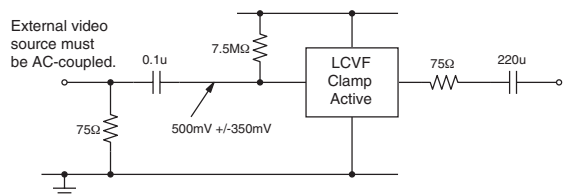

Figure 14. Biased SCART with AC-coupled outputs

NOTE: The video tilt or line time distortion will be dominated by the AC-coupling capacitor. The value may need to be increased beyond 220μF in order to obtain satisfactory operation in some applications.

Power Dissipation

The FMS6363 output drive configuration must be considered when calculating overall power dissipation. Care must be taken not to exceed the maximum die junction temperature. The following example can be used to calculate the FMS6363's power dissipation and internal temperature rise.

$$T_j = T_A + P_d \cdot \Theta_{JA}$$

$$\text{where } P_d = P_{CH1} + P_{CH2} + P_{CH3}$$

$$\text{and } P_{CHx} = V_s \cdot I_{CH} - (V_O^2/R_L)$$

where

$$V_O = 2V_{in} + 0.280V$$

$$I_{CH} = (I_{CC} / 3) + (V_O/R_L)$$

V_{in} = RMS value of input signal

$$I_{CC} = 24mA$$

$$V_s = 5V$$

R_L = channel load resistance

Board layout can also affect thermal characteristics. Refer to the *Layout Considerations* Section for more information.

The FMS6363 is specified to operate with output currents typically less than 50mA, more than sufficient for a single (150Ω) video load. Internal amplifiers are current limited to a maximum of 100mA and should withstand brief duration short circuit conditions, however this capability is not guaranteed.

Layout Considerations

General layout and supply bypassing play major roles in high frequency performance and thermal characteristics. Fairchild offers a demonstration board, FMS6363DEMO, to use as a guide for layout and to aid in device testing and characterization. The FMS6363DEMO is a 4-layer board with a full power and ground plane. For optimum results, follow the steps below as a basis for high frequency layout:

- Include 10μF and 0.1μF ceramic bypass capacitors
- Place the 10μF capacitor within 0.75 inches of the power pin
- Place the 0.1μF capacitor within 0.1 inches of the power pin
- Connect all external ground pins as tightly as possible, preferably with a large ground plane under the package
- Layout channel connections to reduce mutual trace inductance
- Minimize all trace lengths to reduce series inductances. If routing across a board, place device such that longer traces are at the inputs rather than the outputs.

If using multiple, low impedance DC coupled outputs, special layout techniques may be employed to help dissipate heat.

If a multilayer board is used, a large ground plane directly under the device will help reduce package case temperature.

For dual layer boards, an extended plane can be used.

Worse case additional die power due to DC loading can be estimated at $(V_{CC}^2/4R_{load})$ per output channel. This assumes a constant DC output voltage of V_{CC}^2 . For 5V Vcc with a dual DC video load, add $25/(4 \cdot 75) = 83mW$, per channel.

Typical Application Diagram

The following circuit may be used for direct DC-coupled drive by DACs with an output voltage range of 0V to 1.4V. AC-coupled or DC-coupled outputs may be used with AC-coupled outputs offering slightly lower power dissipation.

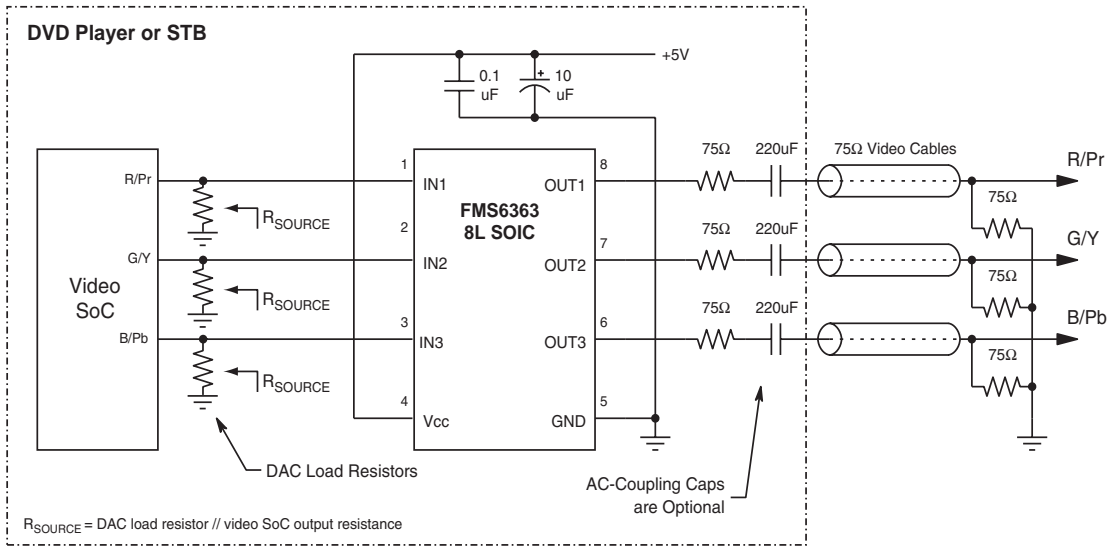
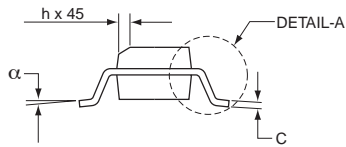
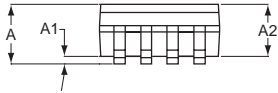
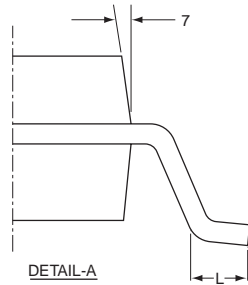
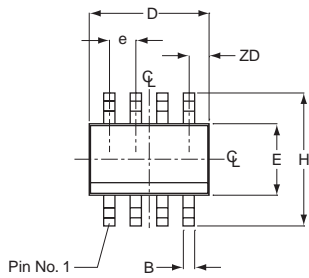

Figure 15. Typical application diagram

Mechanical Dimensions

8-Lead Small Outline Package (SOIC)



SOIC-8		
SYMBOL	MIN	MAX
A1	0.10	0.25
B	0.36	0.46
C	0.19	0.25
D	4.80	4.98
E	3.81	3.99
e	1.27 BSC	
H	5.80	6.20
h	0.25	0.50
L	0.41	1.27
A	1.52	1.72
	0°	8°
ZD	0.53 ref	
A2	1.37	1.57

NOTE:

1. All dimensions are in millimeters.
2. Lead coplanarity should be 0 to 0.10mm (.004") max.
3. Package surface finishing:
 - (2.1) Top: matte (charmilles #18-30).
 - (2.2) All sides: matte (charmilles #18-30).
 - (2.3) Bottom: smooth or matte (charmilles #18-30).
4. All dimensions excluding mold flashes and end flash from the package body shall not exceed 0.152mm (.006) per side (D).

Ordering Information

Model	Part Number	Lead Free	Package	Container	Pack Qty
FMS6363	FMS6363CS	Yes	SOIC-8	Rail	95
FMS6363	FMS6363CSX	Yes	SOIC-8	Reel	2500

Temperature range for all parts: 0°C to 70°C.

TRADEMARKS

The following are registered and unregistered trademarks Fairchild Semiconductor owns or is authorized to use and is not intended to be an exhaustive list of all such trademarks.

ACEx™	FAST®	IntelliMAX™	POP™	SPM™
ActiveArray™	FASTr™	ISOPLANAR™	Power247™	Stealth™
Bottomless™	FPS™	LittleFET™	PowerEdge™	SuperFET™
CoolFET™	FRFET™	MICROCOUPLER™	PowerSaver™	SuperSOT™-3
CROSSVOLT™	GlobalOptoisolator™	MicroFET™	PowerTrench®	SuperSOT™-6
DOME™	GTO™	MicroPak™	QFET®	SuperSOT™-8
EcoSPARK™	HiSeC™	MICROWIRE™	QS™	SyncFET™
E ² CMOS™	I ² C™	MSX™	QT Optoelectronics™	TinyLogic®
EnSigna™	i-Lo™	MSXPro™	Quiet Series™	TINYOPTO™
FACT™	ImpliedDisconnect™	OCX™	RapidConfigure™	TruTranslation™
FACT Quiet Series™		OCXPro™	RapidConnect™	UHC™
Across the board. Around the world.™		OPTOLOGIC®	µSerDes™	UltraFET®
The Power Franchise®		OPTOPLANAR™	SILENT SWITCHER®	UniFET™
Programmable Active Droop™		PACMAN™	SMART START™	VCX™

DISCLAIMER

FAIRCHILD SEMICONDUCTOR RESERVES THE RIGHT TO MAKE CHANGES WITHOUT FURTHER NOTICE TO ANY PRODUCTS HEREIN TO IMPROVE RELIABILITY, FUNCTION OR DESIGN. FAIRCHILD DOES NOT ASSUME ANY LIABILITY ARISING OUT OF THE APPLICATION OR USE OF ANY PRODUCT OR CIRCUIT DESCRIBED HEREIN; NEITHER DOES IT CONVEY ANY LICENSE UNDER ITS PATENT RIGHTS, NOR THE RIGHTS OF OTHERS.

LIFE SUPPORT POLICY

FAIRCHILD'S PRODUCTS ARE NOT AUTHORIZED FOR USE AS CRITICAL COMPONENTS IN LIFE SUPPORT DEVICES OR SYSTEMS WITHOUT THE EXPRESS WRITTEN APPROVAL OF FAIRCHILD SEMICONDUCTOR CORPORATION. As used herein:

- | | |
|---|---|
| <p>1. Life support devices or systems are devices or systems which, (a) are intended for surgical implant into the body, or (b) support or sustain life, or (c) whose failure to perform when properly used in accordance with instructions for use provided in the labeling, can be reasonably expected to result in significant injury to the user.</p> | <p>2. A critical component is any component of a life support device or system whose failure to perform can be reasonably expected to cause the failure of the life support device or system, or to affect its safety or effectiveness.</p> |
|---|---|

PRODUCT STATUS DEFINITIONS

Definition of Terms

Datasheet Identification	Product Status	Definition
Advance Information	Formative or In Design	This datasheet contains the design specifications for product development. Specifications may change in any manner without notice.
Preliminary	First Production	This datasheet contains preliminary data, and supplementary data will be published at a later date. Fairchild Semiconductor reserves the right to make changes at any time without notice in order to improve design.
No Identification Needed	Full Production	This datasheet contains final specifications. Fairchild Semiconductor reserves the right to make changes at any time without notice in order to improve design.
Obsolete	Not In Production	This datasheet contains specifications on a product that has been discontinued by Fairchild semiconductor. The datasheet is printed for reference information only.

Rev. I15