



# FNB50560TD1

## Motion SPM® 55 Series

### Features

- UL Certified No. E209204 (UL1557)
- 600 V - 5 A 3-Phase IGBT Inverter Including Control IC for Gate Drive and Protections
- Low-Loss, Short-Circuit Rated IGBTs
- Built-In Bootstrap Diodes in HVIC
- Separate Open-Emitter Pins from Low-Side IGBTs for Three-Phase Current Sensing
- Active-HIGH interface, works with 3.3 / 5 V Logic, Schmitt-trigger Input
- HVIC for Gate Driving, Under-Voltage and Short-Circuit Current Protection
- Fault Output for Under-Voltage and Short-Circuit Current Protection
- Inter-Lock Function to Prevent Short-Circuit
- Shut-Down Input
- HVIC Temperature-Sensing Built-In for Temperature Monitoring
- Optimized for 15 - 20 kHz Switching Frequency
- Isolation Rating: 1500 V<sub>rms</sub> / min.

### Applications

- Motion Control - Home Appliance / Industrial Motor

### Related Resources

- [AN-9096 - Smart Power Module, Motion SPM® 55 Series User's Guide](#)
- [AN-9097 - SPM® 55 Packing Mounting Guidance](#)

### General Description

FNB50560TD1 is a Motion SPM 55 module providing a fully-featured, high-performance inverter output stage for AC Induction, BLDC, and PMSM motors. These modules integrate optimized gate drive of the built-in IGBTs to minimize EMI and losses, while also providing multiple on-module protection features including under-voltage lockouts, inter-lock function, over-current shutdown, thermal monitoring of drive IC, and fault reporting. The built-in, high-speed HVIC requires only a single supply voltage and translates the incoming logic-level gate inputs to the high-voltage, high-current drive signals required to properly drive the module's robust short-circuit-rated IGBTs. Separate negative IGBT terminals are available for each phase to support the widest variety of control algorithms.



**Figure 1. 3D Package Drawing**  
(Click to Activate 3D Content)

### Package Marking and Ordering Information

Device	Device Marking	Package	Packing Type	Quantity
FNB50560TD1	FNB50560TD1	SPMFA-A20	RAIL	13

### Integrated Power Functions

- 600 V - 5 A IGBT inverter for three phase DC / AC power conversion (Please refer to Figure 3)

### Integrated Drive, Protection and System Control Functions

- For inverter high-side IGBTs: gate drive circuit, high-voltage isolated high-speed level shifting control circuit Under-Voltage Lock-Out (UVLO) protection
- For inverter low-side IGBTs: gate drive circuit, Short-Circuit Protection (SCP) control supply circuit Under-Voltage Lock-Out (UVLO) protection
- Fault signaling: corresponding to UVLO (low-side supply) and SC faults
- Input interface: High-active interface, works with 3.3 / 5 V logic, Schmitt trigger input
- Built in Bootstrap circuitry in HVIC

### Pin Configuration

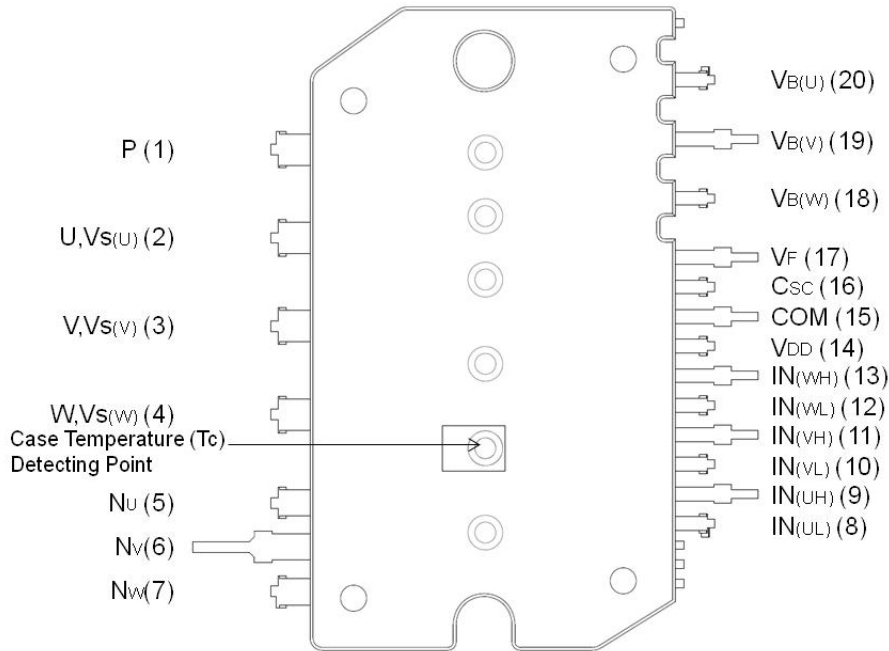
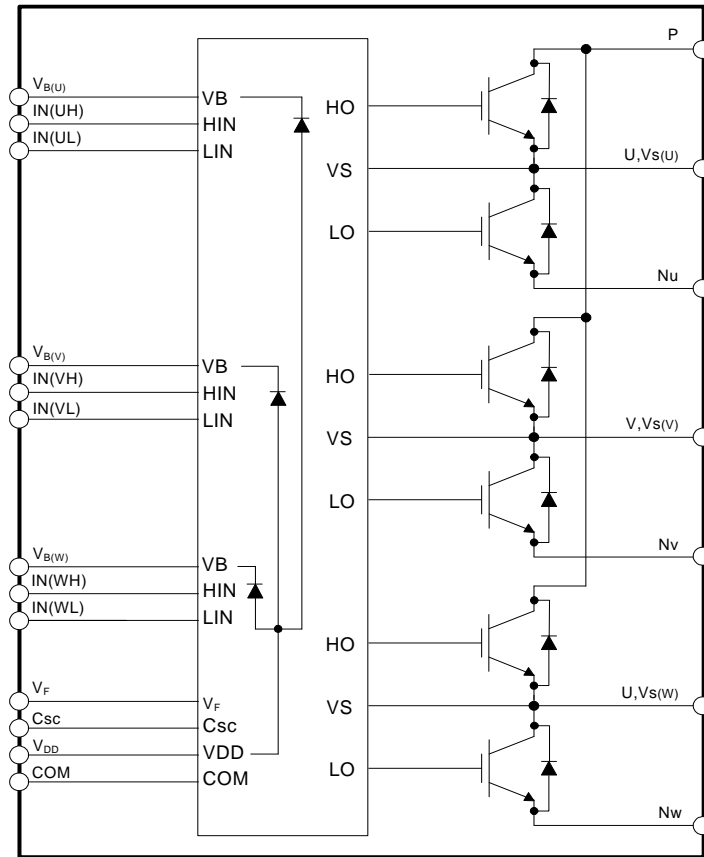

Figure 2. Top View

## Pin Descriptions

Pin Number	Pin Name	Pin Description
1	P	Positive DC-Link Input
2	U, $V_S(U)$	Output for U Phase
3	V, $V_S(V)$	Output for V Phase
4	W, $V_S(W)$	Output for W Phase
5	$N_U$	Negative DC-Link Input for U Phase
6	$N_V$	Negative DC-Link Input for V Phase
7	$N_W$	Negative DC-Link Input for W Phase
8	$IN_{(UL)}$	Signal Input for Low-Side U Phase
9	$IN_{(UH)}$	Signal Input for High-Side U Phase
10	$IN_{(VL)}$	Signal Input for Low-Side V Phase
11	$IN_{(VH)}$	Signal Input for High-Side V Phase
12	$IN_{(WL)}$	Signal Input for Low-Side W Phase
13	$IN_{(WH)}$	Signal Input for High-Side W Phase
14	$V_{DD}$	Common Bias Voltage for IC and IGBTs Driving
15	COM	Common Supply Ground
16	$C_{SC}$	Capacitor (Low-Pass Filter) for Short-circuit Current Detection Input
17	$V_F$	Fault Output, Shut-Down Input, Temperature Output of Drive IC
18	$V_{B(W)}$	High-Side Bias Voltage for W-Phase IGBT Driving
19	$V_{B(V)}$	High-Side Bias Voltage for V-Phase IGBT Driving
20	$V_{B(U)}$	High-Side Bias Voltage for U-Phase IGBT Driving

### Internal Equivalent Circuit and Input/Output Pins



**Figure 3. Internal Block Diagram**

**Note:**

1. Inverter high-side is composed of three IGBTs, freewheeling diodes, and one control IC for each IGBT.
2. Inverter low-side is composed of three IGBTs, freewheeling diodes, and one control IC for each IGBT. It has gate drive and protection functions.
3. Single drive IC has gate driver for six IGBTs and protection functions.
4. Inverter power side is composed of four inverter DC-link input terminals and three inverter output terminals.

## Absolute Maximum Ratings ( $T_J = 25^\circ\text{C}$ , unless otherwise specified.)

### Inverter Part

Symbol	Parameter	Conditions	Rating	Unit
$V_{PN}$	Supply Voltage	Applied between P - $N_U$ , $N_V$ , $N_W$	450	V
$V_{PN(\text{Surge})}$	Supply Voltage (Surge)	Applied between P - $N_U$ , $N_V$ , $N_W$	500	V
$V_{CES}$	Collector - Emitter Voltage		600	V
* $\pm I_C$	Each IGBT Collector Current	$T_C = 25^\circ\text{C}$ , $T_J < 150^\circ\text{C}$	5	A
* $\pm I_{CP}$	Each IGBT Collector Current (Peak)	$T_C = 25^\circ\text{C}$ , $T_J < 150^\circ\text{C}$ , Under 1 ms Pulse Width	10	A
* $P_C$	Collector Dissipation	$T_C = 25^\circ\text{C}$ per Chip	19	W
$T_J$	Operating Junction Temperature	(Note 5)	-40 ~ 150	$^\circ\text{C}$

**Note:**

5. The maximum junction temperature rating of the power chips integrated within the Motion SPM® 55 product is 150°C.

### Control Part

Symbol	Parameter	Conditions	Rating	Unit
$V_{DD}$	Control Supply Voltage	Applied between $V_{DD}$ - COM	20	V
$V_{BS}$	High-Side Control Bias Voltage	Applied between $V_{B(U)}$ - $V_{S(U)}$ , $V_{B(V)}$ - $V_{S(V)}$ , $V_{B(W)}$ - $V_{S(W)}$	20	V
$V_{IN}$	Input Signal Voltage	Applied between $IN_{(UH)}$ , $IN_{(VH)}$ , $IN_{(WH)}$ , $IN_{(UL)}$ , $IN_{(VL)}$ , $IN_{(WL)}$ - COM	-0.3 ~ $V_{DD} + 0.3$	V
$V_F$	Fault Supply Voltage	Applied between $V_F$ - COM	-0.3 ~ $V_{DD} + 0.3$	V
* $I_F$	Fault Current	Sink Current at $V_F$ pin	5	mA
$V_{SC}$	Current Sensing Input Voltage	Applied between $C_{SC}$ - COM	-0.3 ~ $V_{DD} + 0.3$	V

### Total System

Symbol	Parameter	Conditions	Rating	Unit
$V_{PN(\text{PROT})}$	Self Protection Supply Voltage Limit (Short Circuit Protection Capability)	$V_{DD} = V_{BS} = 13.5 \sim 16.5 \text{ V}$ $T_J = 150^\circ\text{C}$ , Non-Repetitive, $< 2 \mu\text{s}$	400	V
$T_{STG}$	Storage Temperature		-40 ~ 125	$^\circ\text{C}$
$V_{ISO}$	Isolation Voltage Connect Pins to Heat Sink Plate	AC 60 Hz, Sinusoidal, 1 Minute	1500	$V_{\text{rms}}$

### Thermal Resistance

Symbol	Parameter	Conditions	Min.	Typ.	Max.	Unit
$R_{th(j-c)Q}$	Junction to Case Thermal Resistance (Note 7)	Inverter IGBT part (per 1 / 6 module)	-	-	6.5	$^\circ\text{C} / \text{W}$
$R_{th(j-c)F}$		Inverter FWD part (per 1 / 6 module)	-	-	8.9	$^\circ\text{C} / \text{W}$

**Note:**

6. For Marking " \* ", These Value had been made an acquisition by the calculation considered to design factor.

7. For the measurement point of case temperature ( $T_C$ ), please refer to Figure 2.

**Electrical Characteristics** ( $T_J = 25^\circ\text{C}$ , unless otherwise specified.)

**Inverter Part**

Symbol	Parameter	Conditions	Min.	Typ.	Max.	Unit	
$V_{CE(SAT)}$	Collector - Emitter Saturation Voltage	$V_{DD} = V_{BS} = 15\text{ V}$ $V_{IN} = 5\text{ V}$ $I_C = 4\text{ A}$	$T_J = 25^\circ\text{C}$	-	1.9	2.25	V
			$T_J = 150^\circ\text{C}$	-	2.4	-	V
$V_F$	FWDi Forward Voltage	$V_{IN} = 0\text{ V}$ $I_F = 4\text{ A}$	$T_J = 25^\circ\text{C}$	-	2.2	2.55	V
			$T_J = 150^\circ\text{C}$	-	2.0	-	V
HS	Switching Times	$V_{PN} = 400\text{ V}$ , $V_{DD} = V_{BS} = 15\text{ V}$ , $I_C = 5\text{ A}$ $T_J = 25^\circ\text{C}$ $V_{IN} = 0\text{ V} \leftrightarrow 5\text{ V}$ , Inductive load (Note 8)	$t_{ON}$	0.30	0.60	0.90	us
			$t_{C(ON)}$	-	0.15	0.35	us
			$t_{OFF}$	-	0.30	0.50	us
			$t_{C(OFF)}$	-	0.08	0.20	us
			$t_{rr}$	-	0.08	-	us
LS	Switching Times	$V_{PN} = 400\text{ V}$ , $V_{DD} = V_{BS} = 15\text{ V}$ , $I_C = 5\text{ A}$ $T_J = 25^\circ\text{C}$ $V_{IN} = 0\text{ V} \leftrightarrow 5\text{ V}$ , Inductive load (Note 8)	$t_{ON}$	0.30	0.60	0.90	us
			$t_{C(ON)}$	-	0.15	0.35	us
			$t_{OFF}$	-	0.30	0.50	us
			$t_{C(OFF)}$	-	0.08	0.20	us
			$t_{rr}$	-	0.08	-	us
$I_{CES}$	Collector - Emitter Leakage Current	$V_{CE} = V_{CES}$	-	-	1	mA	

**Note:**

8.  $t_{ON}$  and  $t_{OFF}$  include the propagation delay of the internal drive IC.  $t_{C(ON)}$  and  $t_{C(OFF)}$  are the switching time of IGBT itself under the given gate driving condition internally. For the detailed information, please see Figure 4.

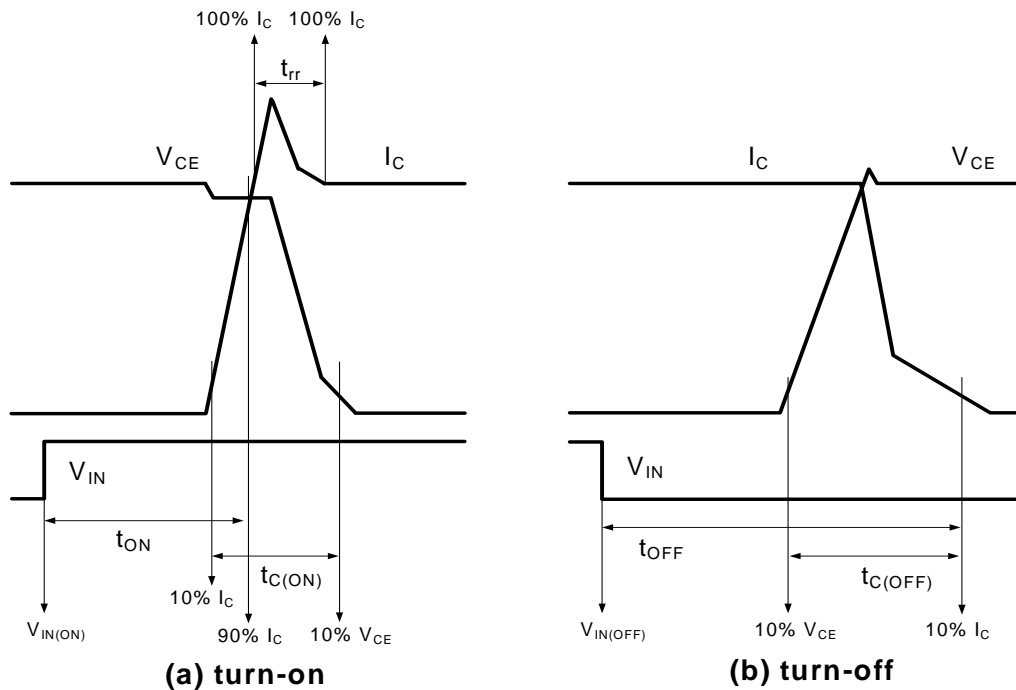

**Figure 4. Switching Time Definition**

**Control Part**

Symbol	Parameter	Conditions	Min.	Typ.	Max.	Unit	
I <sub>QDD</sub>	Quiescent V <sub>DD</sub> Supply Current	V <sub>DD</sub> = 15 V, IN <sub>(UH,VH,WH,UL,VL,WL)</sub> = 0 V	V <sub>DD</sub> - COM	-	1.5	2.0	mA
I <sub>PDD</sub>	Operating V <sub>DD</sub> Supply Current	V <sub>DD</sub> = 15 V, f <sub>PWM</sub> = 20 kHz, duty = 50%, applied to one PWM signal input	V <sub>DD</sub> - COM	-	2.0	2.5	mA
I <sub>QBS</sub>	Quiescent V <sub>BS</sub> Supply Current	V <sub>BS</sub> = 15 V, IN <sub>(UH, VH, WH)</sub> = 0 V	V <sub>B(U)</sub> - V <sub>S(U)</sub> , V <sub>B(V)</sub> - V <sub>S(V)</sub> , V <sub>B(W)</sub> - V <sub>S(W)</sub>	-	30	60	μA
I <sub>PBS</sub>	Operating V <sub>BS</sub> Supply Current	V <sub>DD</sub> = V <sub>BS</sub> = 15 V, f <sub>PWM</sub> = 20 kHz, duty = 50%, applied to one PWM signal input for high - side	V <sub>B(U)</sub> - V <sub>S(U)</sub> , V <sub>B(V)</sub> - V <sub>S(V)</sub> , V <sub>B(W)</sub> - V <sub>S(W)</sub>	-	500	650	μA
V <sub>FH</sub>	Fault Output Voltage	V <sub>SC</sub> = 0 V, V <sub>F</sub> Circuit: 10 kΩ to 5 V Pull-up	4.5	-	-	V	
V <sub>FL</sub>		V <sub>SC</sub> = 1 V, V <sub>F</sub> Circuit: 10 kΩ to 5 V Pull-up	-	-	0.5	V	
V <sub>SC(ref)</sub>	Short-Circuit Trip Level	V <sub>DD</sub> = 15 V (Note 4)	0.45	0.5	0.55	V	
UV <sub>DDD</sub>	Supply Circuit Under-Voltage Protection	Detection level	10.7	11.4	12.1	V	
UV <sub>DDR</sub>		Reset level	11.2	12.3	13.0	V	
UV <sub>BSD</sub>		Detection level	10.1	10.8	11.5	V	
UV <sub>BSR</sub>		Reset level	10.7	11.4	12.1	V	
I <sub>FT</sub>	HVIC Temperature Sensing Current	V <sub>DD</sub> = V <sub>BS</sub> = 15 V, T <sub>HVIC</sub> = 25°C	68	81	95	μA	
V <sub>FT</sub>	HVIC Temperature Sensing Voltage	V <sub>DD</sub> = V <sub>BS</sub> = 15 V, T <sub>HVIC</sub> = 25°C, 10 kΩ to 5 V Pull-up (Figure. 5)	4.05	4.19	4.32	V	
t <sub>FOD</sub>	Fault-Out Pulse Width		40	120	-	μs	
V <sub>FSDR</sub>	Shut-down Reset level	Applied between V <sub>F</sub> - COM	-	-	2.4	V	
V <sub>FSDS</sub>	Shut-down Set level		0.8	-	-	V	
V <sub>IN(ON)</sub>	ON Threshold Voltage	Applied between IN <sub>(UH)</sub> , IN <sub>(VH)</sub> , IN <sub>(WH)</sub> , IN <sub>(UL)</sub> , IN <sub>(VL)</sub> , IN <sub>(WL)</sub> - COM	-	-	2.4	V	
V <sub>IN(OFF)</sub>	OFF Threshold Voltage		0.8	-	-	V	

**Note:**

9. Short-circuit protection is functioning for all six IGBTs.

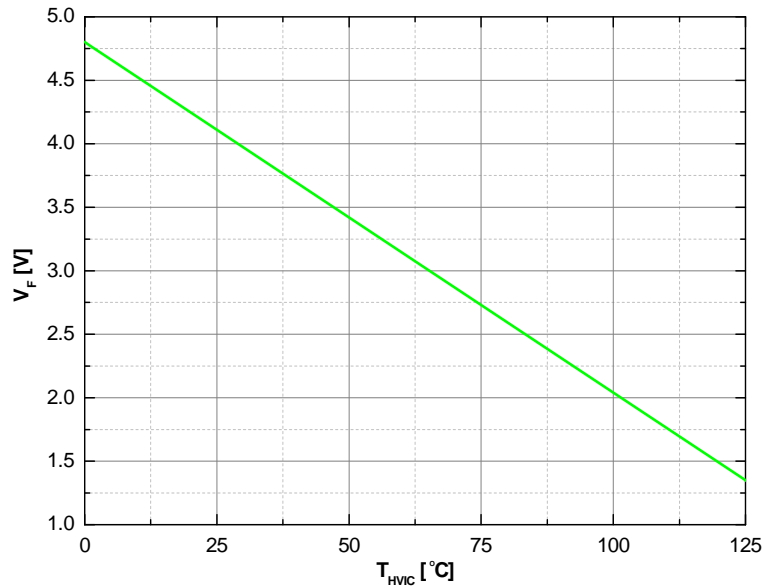

**Figure. 5. V-T Curve of Temperature Output of IC (5V pull-up with 10kohm)**

### Bootstrap Diode Part

Symbol	Parameter	Conditions	Min.	Typ.	Max.	Unit
R <sub>BS</sub>	Bootstrap Diode Resitance	V <sub>DD</sub> = 15V, T <sub>C</sub> = 25°C	-	280	-	Ω

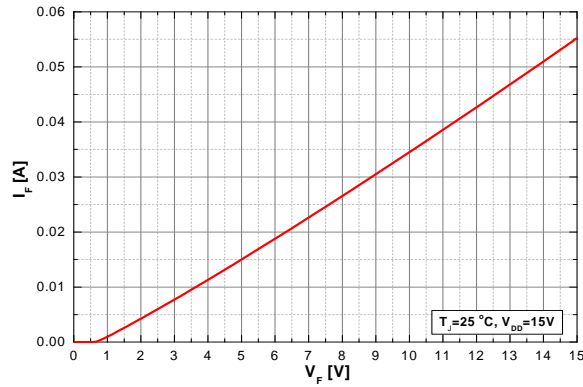

Figure 6. Built-In Bootstrap Diode Charatersts

### Recommended Operating Conditions

Symbol	Parameter	Conditions	Min.	Typ.	Max.	Unit
V <sub>PN</sub>	Supply Voltage	Applied between P - N <sub>U</sub> , N <sub>V</sub> , N <sub>W</sub>	-	300	400	V
V <sub>DD</sub>	Control Supply Voltage	Applied between V <sub>DD</sub> - COM	14.0	15	16.5	V
V <sub>BS</sub>	High - Side Bias Voltage	Applied between V <sub>B(U)</sub> - V <sub>S(U)</sub> , V <sub>B(V)</sub> - V <sub>S(V)</sub> , V <sub>B(W)</sub> - V <sub>S(W)</sub>	13.0	15	18.5	V
dV <sub>DD</sub> / dt, dV <sub>BS</sub> / dt	Control Supply Variation		-1	-	1	V / μs
t <sub>dead</sub>	Blanking Time for Preventing Arm - Short	For each input signal	0.5	-	-	μs
f <sub>PWM</sub>	PWM Input Signal	- 40°C < T <sub>J</sub> < 150°C	-	-	20	kHz
V <sub>SEN</sub>	Voltage for Current Sensing	Applied between N <sub>U</sub> , N <sub>V</sub> , N <sub>W</sub> - COM (Including surge voltage)	-4		4	V
P <sub>WIN(ON)</sub>	Minimum Input Pulse Width	(Note 10)	0.7	-	-	μs
P <sub>WIN(OFF)</sub>			0.7	-	-	

**Note:**

10. This product might not make response if input pulse width is less than the recommended value.

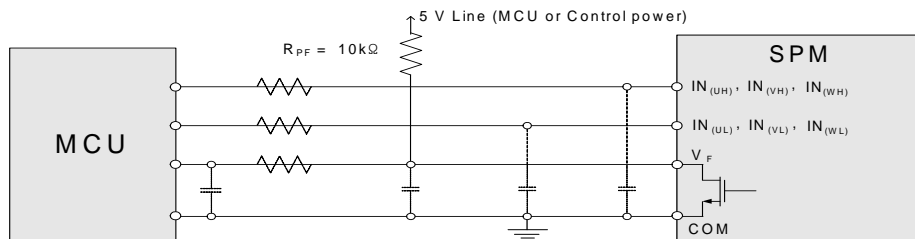

**Note:**

11. RC coupling at each input (parts shown dotted) might change depending on the PWM control scheme used in the application and the wiring impedance of the application's printed circuit board. The input signal section of the SPM 55 product integrates 10 kΩ (typ.) pull-down resistor. Therefore, when using an external filtering resistor, please pay attention to the signal voltage drop at input terminal.

Figure 7. Recommended MCU I/O Interface Circuit



## Mechanical Characteristics and Ratings

Parameter	Conditions	Min.	Typ.	Max.	Unit	
Device Flatness	See Figure 8	-50	-	100	μm	
Mounting Torque	Mounting Screw: - M3	Recommended 0.7 N • m	0.6	0.7	0.8	N • m
	Note Figure 9	Recommended 7.1 kg • cm	5.9	6.9	7.9	kg • cm
Weight		-	6.0	-	g	

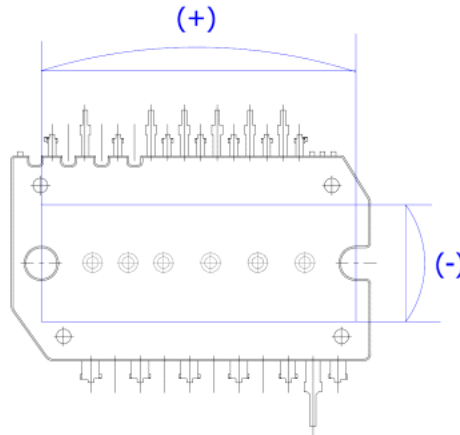

**Figure 8. Flatness Measurement Position**

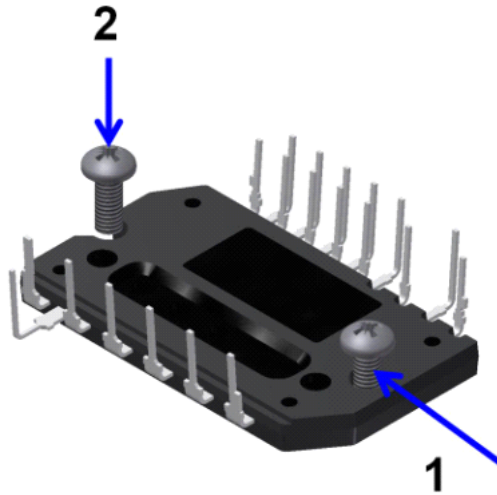
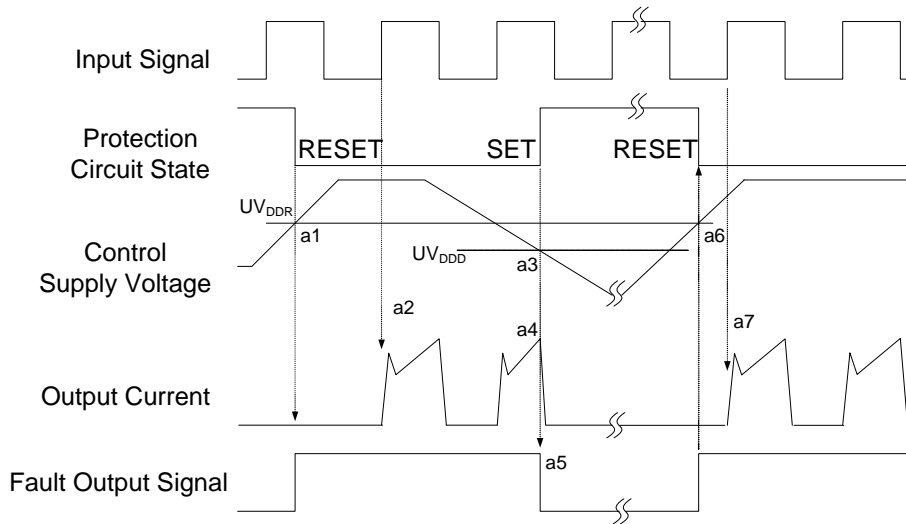

**Figure 9. Mounting Screws Torque Order**

**Note:**

- 12. Do not make over torque when mounting screws. Much mounting torque may cause package cracks, as well as bolts and Al heat-sink destruction.
- 13. Avoid one side tightening stress. Figure 10 shows the recommended torque order for mounting screws. Uneven mounting can cause the ceramic substrate of the Motion SPM 55 product to be damaged. The Pre-screwing torque is set to 20 ~ 30 % of maximum torque rating.

### Time Charts of Protective Function



- a1 : Control supply voltage rises: After the voltage rises  $UV_{DDR}$ , the circuits start to operate when next input is applied.
- a2 : Normal operation: IGBT ON and carrying current.
- a3 : Under voltage detection ( $UV_{DDD}$ ).
- a4 : IGBT OFF in spite of control input condition.
- a5 : Fault output operation starts.
- a6 : Under voltage reset ( $UV_{DDR}$ ).
- a7 : Normal operation: IGBT ON and carrying current.

**Figure 10. Under-Voltage Protection (Low-Side)**

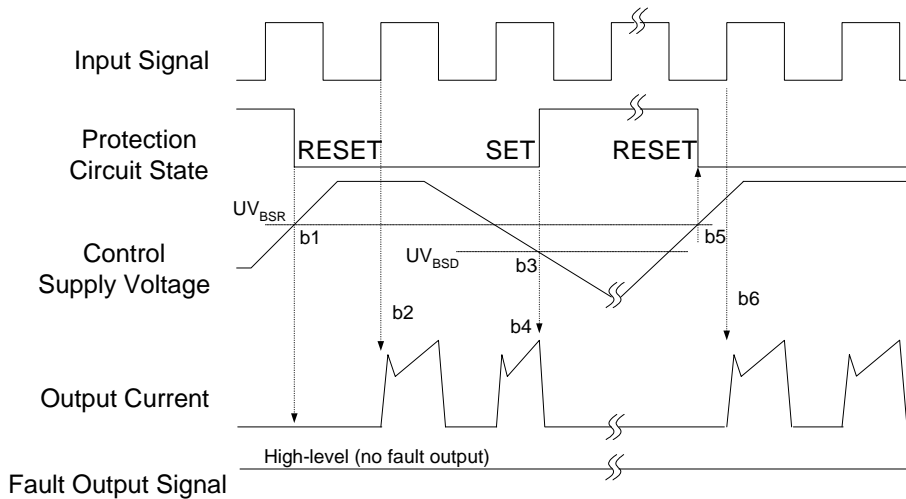

- b1 : Control supply voltage rises: After the voltage reaches  $UV_{BSR}$ , the circuits start to operate when next input is applied.
- b2 : Normal operation: IGBT ON and carrying current.
- b3 : Under voltage detection ( $UV_{BSD}$ ).
- b4 : IGBT OFF in spite of control input condition, but there is no fault output signal.
- b5 : Under voltage reset ( $UV_{BSR}$ )
- b6 : Normal operation: IGBT ON and carrying current

**Figure 11. Under-Voltage Protection (High-Side)**

(with the external shunt resistance and CR connection)

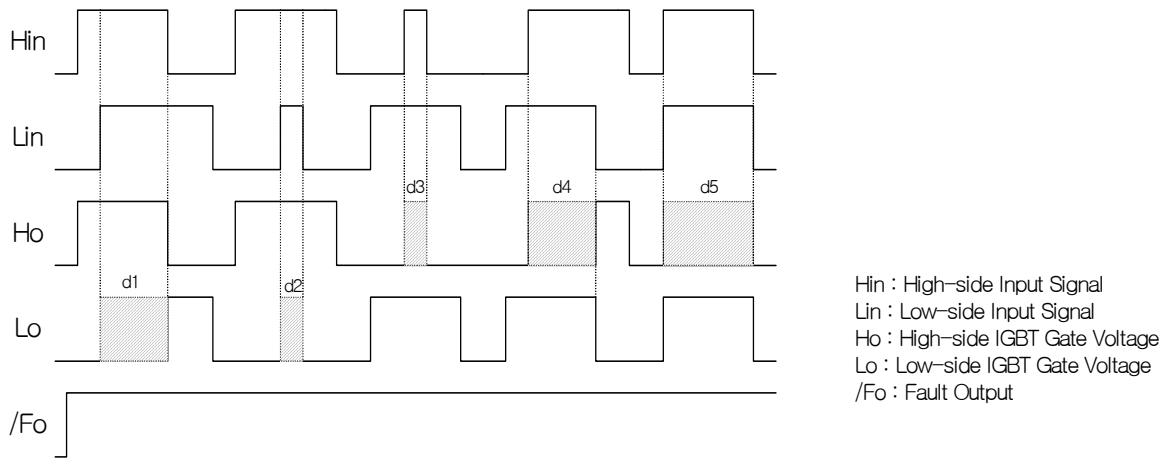

- d1 : High Side First - Input - First - Output Mode
- d2 : Low Side Noise Mode : No Lo
- d3 : High Side Noise Mode : No Ho
- d4 : Low Side First - Input - First - Output Mode
- d5 : In - Phase Mode : No Ho

**Figure 12. Inter-Lock Function**

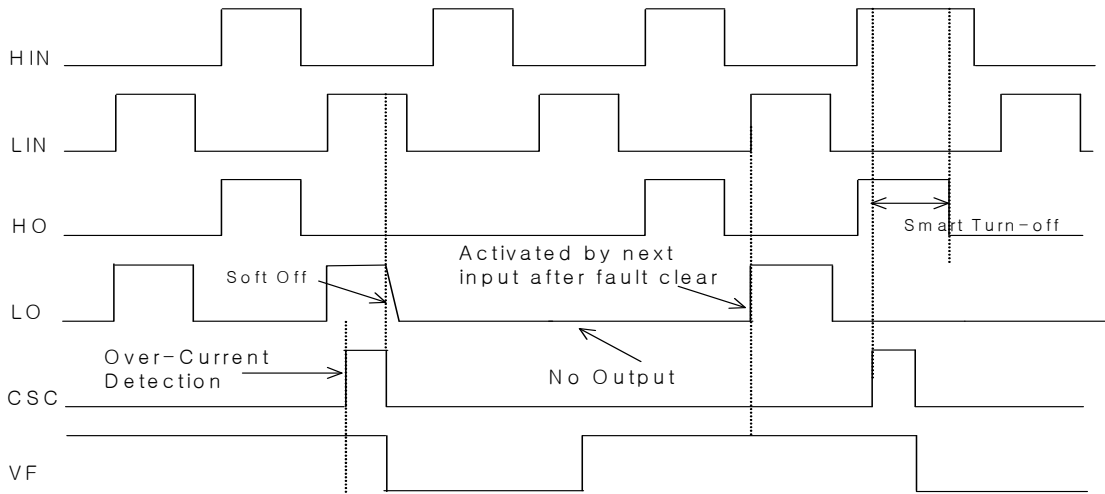

**Figure 13. Fault-Out Function By Over Current Protection**

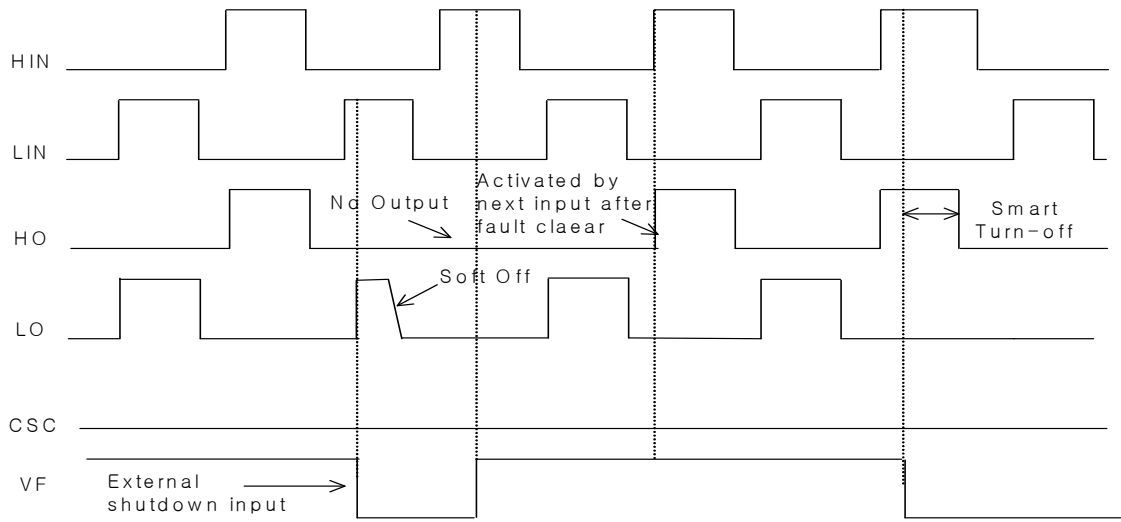

HIN : High-side Input Signal  
 LIN : Low-side Input Signal  
 HO : High-Side Output Signal  
 LO : Low-Side Output Signal  
 CSC : Over Current Detection Input  
 VF : Shutdown Input Function

**Figure 14. Shutdown Input Function By External Command**



Detailed Package Outline Drawings (FNB50560TD1, Short Lead)

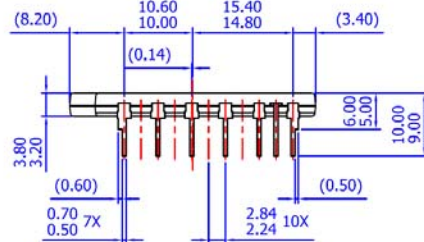
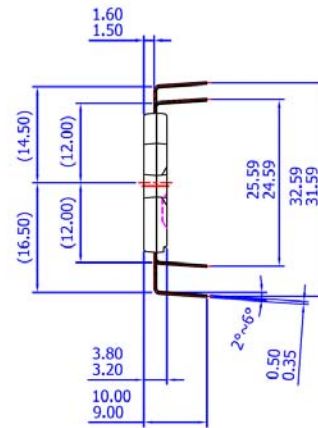
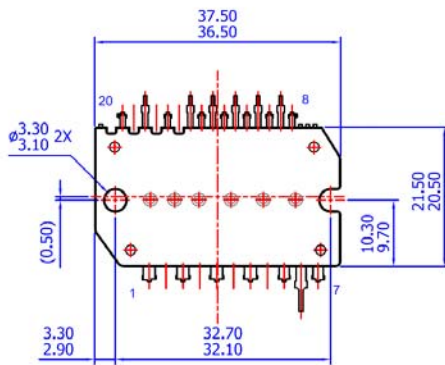
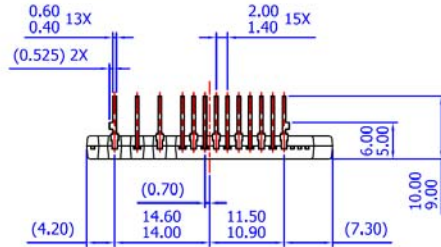





- NOTES: UNLESS OTHERWISE SPECIFIED  
 A) THIS PACKAGE DOES NOT COMPLY TO ANY CURRENT PACKAGING STANDARD  
 B) ALL DIMENSIONS ARE IN MILLIMETERS  
 C) DIMENSIONS ARE EXCLUSIVE OF BURRS, MOLD FLASH, AND TIE BAR EXTRUSIONS  
 D) ( ) IS REFERENCE  
 E) [ ] IS ASS'Y QUALITY  
 F) DRAWING FILENAME: MOD20DBREV2

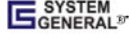

## TRADEMARKS

The following includes registered and unregistered trademarks and service marks, owned by Fairchild Semiconductor and/or its global subsidiaries, and is not intended to be an exhaustive list of all such trademarks.

AccuPower™	F-PFS™	OPTOPLANAR®	 SYSTEM GENERAL®
AttitudeEngine™	FRFET®	 ®	TinyBoost®
Awinda®	Global Power Resource™	Power Supply WebDesigner™	TinyBuck®
AX-CAP®*	GreenBridge™	PowerTrench®	TinyCalc™
BitSiC™	Green FPS™	PowerXS™	TinyLogic®
Build it Now™	Green FPS™ e-Series™	Programmable Active Droop™	TINYOPTO™
CorePLUS™	Gmax™	QFET®	TinyPower™
CorePOWER™	GTO™	QS™	TinyPWM™
CROSSVOLT™	IntelliMAX™	Quiet Series™	TinyWire™
CTL™	ISOPLANAR™	RapidConfigure™	TranSiC™
Current Transfer Logic™	Making Small Speakers Sound Louder and Better™	 ™	TriFault Detect™
DEUXPEED®	MegaBuck™	Saving our world, 1mW/W/kW at a time™	TRUECURRENT®*
Dual Cool™	MICROCOUPLER™	SignalWise™	µSerDes™
EcoSPARK®	MicroFET™	SmartMax™	 SerDes™
EfficientMax™	MicroPak™	SMART START™	UHC®
ESBC™	MicroPak2™	Solutions for Your Success™	Ultra FRFET™
 Fairchild®	MillerDrive™	SPM®	UniFET™
Fairchild Semiconductor®	MotionMax™	STEALTH™	VCX™
FACT Quiet Series™	MotionGrid®	SuperFET®	VisualMax™
FACT®	MTI®	SuperSOT™-3	VoltagePlus™
FastvCore™	MTX®	SuperSOT™-6	XS™
FETBench™	MVN®	SuperSOT™-8	Xsens™
FPS™	mWSaver®	SupreMOS®	仙童™
	OptoHit™	SyncFET™	
	OPTOLOGIC®	Sync-Lock™	

\* Trademarks of System General Corporation, used under license by Fairchild Semiconductor.

## DISCLAIMER

FAIRCHILD SEMICONDUCTOR RESERVES THE RIGHT TO MAKE CHANGES WITHOUT FURTHER NOTICE TO ANY PRODUCTS HEREIN TO IMPROVE RELIABILITY, FUNCTION, OR DESIGN. TO OBTAIN THE LATEST, MOST UP-TO-DATE DATASHEET AND PRODUCT INFORMATION, VISIT OUR WEBSITE AT [HTTP://WWW.FAIRCHILDSEMI.COM](http://www.fairchildsemi.com). FAIRCHILD DOES NOT ASSUME ANY LIABILITY ARISING OUT OF THE APPLICATION OR USE OF ANY PRODUCT OR CIRCUIT DESCRIBED HEREIN; NEITHER DOES IT CONVEY ANY LICENSE UNDER ITS PATENT RIGHTS, NOR THE RIGHTS OF OTHERS. THESE SPECIFICATIONS DO NOT EXPAND THE TERMS OF FAIRCHILD'S WORLDWIDE TERMS AND CONDITIONS, SPECIFICALLY THE WARRANTY THEREIN, WHICH COVERS THESE PRODUCTS.

## AUTHORIZED USE

Unless otherwise specified in this data sheet, this product is a standard commercial product and is not intended for use in applications that require extraordinary levels of quality and reliability. This product may not be used in the following applications, unless specifically approved in writing by a Fairchild officer: (1) automotive or other transportation, (2) military/aerospace, (3) any safety critical application – including life critical medical equipment – where the failure of the Fairchild product reasonably would be expected to result in personal injury, death or property damage. Customer's use of this product is subject to agreement of this Authorized Use policy. In the event of an unauthorized use of Fairchild's product, Fairchild accepts no liability in the event of product failure. In other respects, this product shall be subject to Fairchild's Worldwide Terms and Conditions of Sale, unless a separate agreement has been signed by both Parties.

## ANTI-COUNTERFEITING POLICY

Fairchild Semiconductor Corporation's Anti-Counterfeiting Policy. Fairchild's Anti-Counterfeiting Policy is also stated on our external website, [www.fairchildsemi.com](http://www.fairchildsemi.com), under Terms of Use

Counterfeiting of semiconductor parts is a growing problem in the industry. All manufacturers of semiconductor products are experiencing counterfeiting of their parts. Customers who inadvertently purchase counterfeit parts experience many problems such as loss of brand reputation, substandard performance, failed applications, and increased cost of production and manufacturing delays. Fairchild is taking strong measures to protect ourselves and our customers from the proliferation of counterfeit parts. Fairchild strongly encourages customers to purchase Fairchild parts either directly from Fairchild or from Authorized Fairchild Distributors who are listed by country on our web page cited above. Products customers buy either from Fairchild directly or from Authorized Fairchild Distributors are genuine parts, have full traceability, meet Fairchild's quality standards for handling and storage and provide access to Fairchild's full range of up-to-date technical and product information. Fairchild and our Authorized Distributors will stand behind all warranties and will appropriately address any warranty issues that may arise. Fairchild will not provide any warranty coverage or other assistance for parts bought from Unauthorized Sources. Fairchild is committed to combat this global problem and encourage our customers to do their part in stopping this practice by buying direct or from authorized distributors.

## PRODUCT STATUS DEFINITIONS

### Definition of Terms

Datasheet Identification	Product Status	Definition
Advance Information	Formative / In Design	Datasheet contains the design specifications for product development. Specifications may change in any manner without notice.
Preliminary	First Production	Datasheet contains preliminary data; supplementary data will be published at a later date. Fairchild Semiconductor reserves the right to make changes at any time without notice to improve design.
No Identification Needed	Full Production	Datasheet contains final specifications. Fairchild Semiconductor reserves the right to make changes at any time without notice to improve the design.
Obsolete	Not In Production	Datasheet contains specifications on a product that is discontinued by Fairchild Semiconductor. The datasheet is for reference information only.

Rev. I76