

## FNK N-Channel Enhancement Mode Power MOSFET

### Description

The FNK01N15 uses advanced trench technology and design to provide excellent  $R_{DS(ON)}$  with low gate charge. It can be used in a wide variety of applications.

### General Features

- $V_{DS} = 100V, I_D = 150A$   
 $R_{DS(ON)} < 5.7m\Omega @ V_{GS} = 10V$  (Typ: 5.0m $\Omega$ )
- High density cell design for ultra low  $R_{dson}$
- Fully characterized avalanche voltage and current
- Good stability and uniformity with high  $E_{AS}$
- Excellent package for good heat dissipation

### Application

- Power switching application
- Load switching
- Uninterruptible power supply

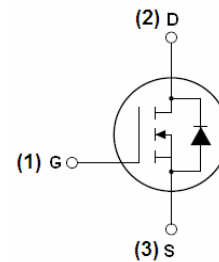

Schematic diagram

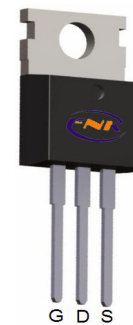

To-220 Top View

### Package Marking and Ordering Information

Device Marking	Device	Device Package	Reel Size	Tape width	Quantity
FNK01N15	FNK01N15	TO-220	-	-	-

### Absolute Maximum Ratings ( $T_C = 25^\circ C$ unless otherwise noted)

Parameter	Symbol	Limit	Unit
Drain-Source Voltage	$V_{DS}$	100	V
Gate-Source Voltage	$V_{GS}$	$\pm 20$	V
Drain Current-Continuous	$I_D$	150	A
Drain Current-Continuous( $T_C = 100^\circ C$ )	$I_D(100^\circ C)$	113	A
Pulsed Drain Current	$I_{DM}$	580	A
Maximum Power Dissipation	$P_D$	370	W
Derating factor		2.5	W/ $^\circ C$
Single pulse avalanche energy <sup>(Note 5)</sup>	$E_{AS}$	433	mJ

Parameter	Symbol	Limit	Unit
Operating Junction and Storage Temperature Range	$T_J, T_{STG}$	-55 To 175	°C

### Thermal Characteristic

Thermal Resistance, Junction-to-Case <sup>(Note 2)</sup>	$R_{\theta JC}$	0.4	°C/W
----------------------------------------------------------	-----------------	-----	------

### Electrical Characteristics ( $T_C=25^\circ\text{C}$ unless otherwise noted)

Parameter	Symbol	Condition	Min	Typ	Max	Unit
<b>Off Characteristics</b>						
Drain-Source Breakdown Voltage	$BV_{DSS}$	$V_{GS}=0V, I_D=250\mu A$	100	110	-	V
Zero Gate Voltage Drain Current	$I_{DSS}$	$V_{DS}=100V, V_{GS}=0V$	-	-	1	$\mu A$
Gate-Body Leakage Current	$I_{GSS}$	$V_{GS}=\pm 20V, V_{DS}=0V$	-	-	$\pm 100$	nA
<b>On Characteristics</b> <sup>(Note 3)</sup>						
Gate Threshold Voltage	$V_{GS(th)}$	$V_{DS}=V_{GS}, I_D=250\mu A$	2	2.8	4	V
Drain-Source On-State Resistance	$R_{DS(on)}$	$V_{GS}=10V, I_D=20A$	-	5.0	5.7	m $\Omega$
Forward Transconductance	$g_{FS}$	$V_{DS}=5V, I_D=20A$	70	-	-	S
<b>Dynamic Characteristics</b> <sup>(Note 4)</sup>						
Input Capacitance	$C_{iss}$	$V_{DS}=25V, V_{GS}=0V,$ $F=1.0\text{MHz}$	-	6470	-	PF
Output Capacitance	$C_{oss}$		-	690	-	PF
Reverse Transfer Capacitance	$C_{rss}$		-	430	-	PF
<b>Switching Characteristics</b> <sup>(Note 4)</sup>						
Turn-on Delay Time	$t_{d(on)}$	$V_{DD}=50V, R_L=2.5\Omega$ $V_{GS}=10V, R_{GEN}=3\Omega$	-	28	-	nS
Turn-on Rise Time	$t_r$		-	22	-	nS
Turn-Off Delay Time	$t_{d(off)}$		-	43.5	-	nS
Turn-Off Fall Time	$t_f$		-	14.5	-	nS
Total Gate Charge	$Q_g$	$V_{DS}=50V, I_D=20A,$ $V_{GS}=10V$	-	139	-	nC
Gate-Source Charge	$Q_{gs}$		-	34	-	nC
Gate-Drain Charge	$Q_{gd}$		-	56	-	nC
<b>Drain-Source Diode Characteristics</b>						
Diode Forward Voltage <sup>(Note 3)</sup>	$V_{SD}$	$V_{GS}=0V, I_S=20A$	-	0.85	1.2	V
Diode Forward Current <sup>(Note 2)</sup>	$I_S$		-	-	160	A
Reverse Recovery Time	$t_{rr}$	$T_J = 25^\circ\text{C}, I_F = 20A$ $di/dt = 100A/\mu s$ <sup>(Note 3)</sup>	-	60	90	nS
Reverse Recovery Charge	$Q_{rr}$		-	177	200	nC

### Notes:

1. Repetitive Rating: Pulse width limited by maximum junction temperature.
2. Surface Mounted on FR4 Board,  $t \leq 10$  sec.
3. Pulse Test: Pulse Width  $\leq 300\mu s$ , Duty Cycle  $\leq 2\%$ .
4. Guaranteed by design, not subject to production
5. EAS condition:  $T_J=25^\circ\text{C}, V_{DD}=50V, V_G=10V, L=0.5\text{mH}, R_g=25\Omega$

## Test Circuit

### 1) E<sub>AS</sub> test Circuit

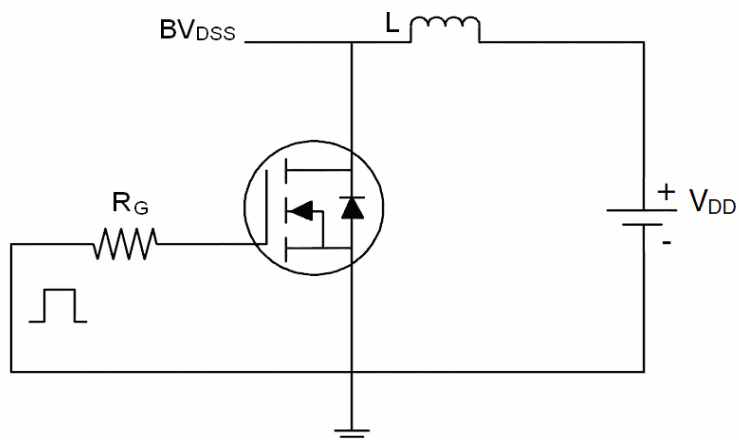

### 2) Gate charge test Circuit

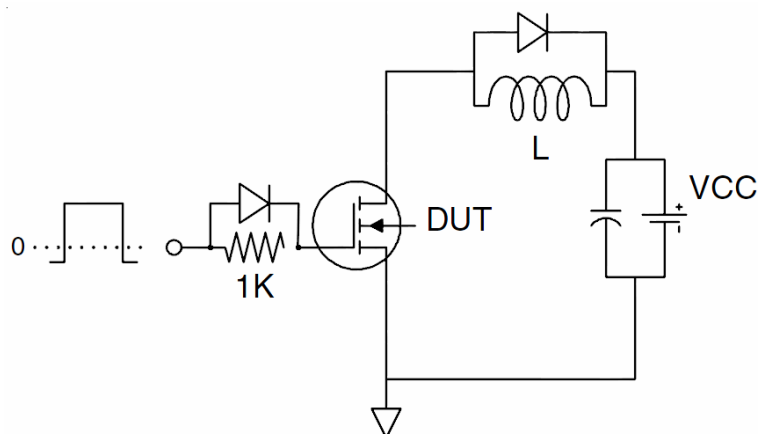

### 3) Switch Time Test Circuit

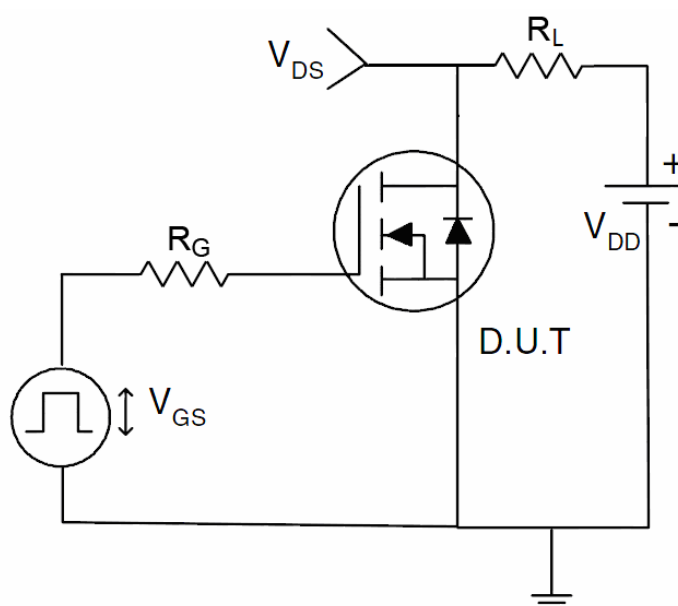

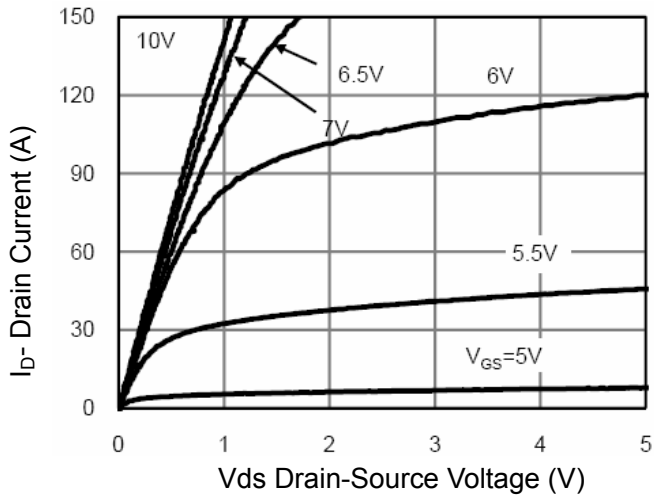
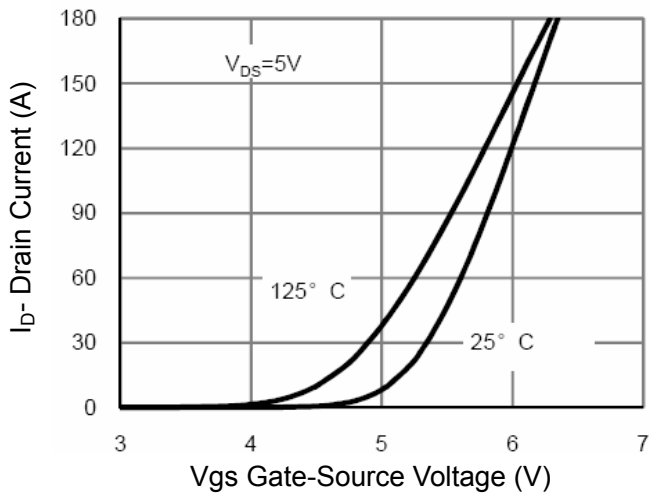
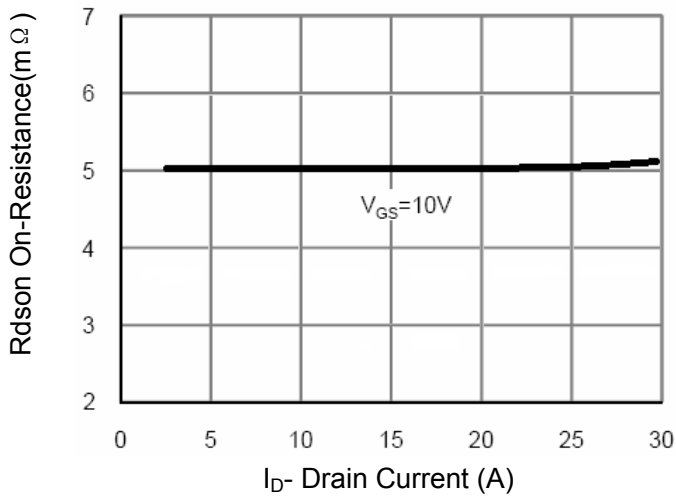
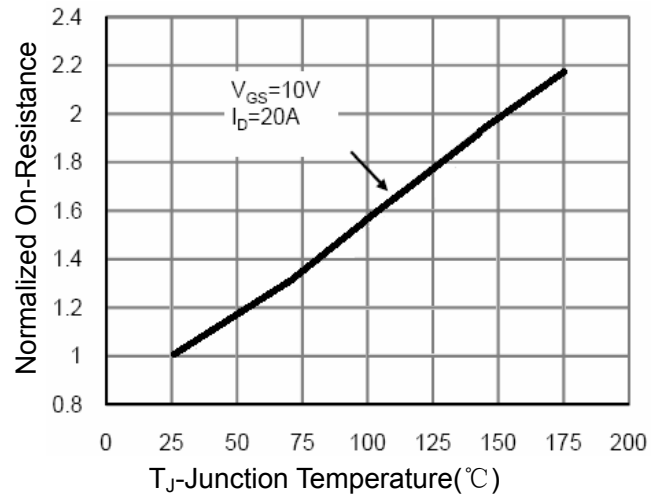
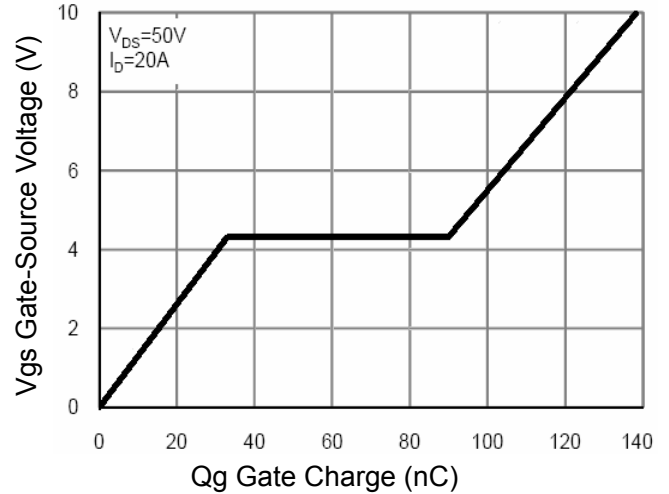
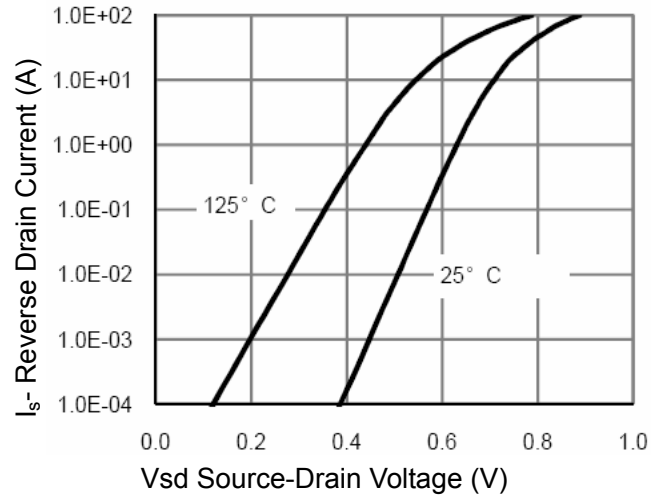
**Typical Electrical and Thermal Characteristics (Curves)**

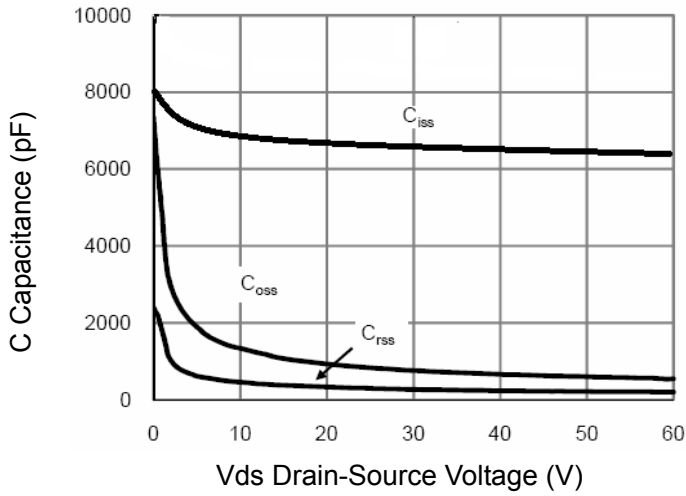
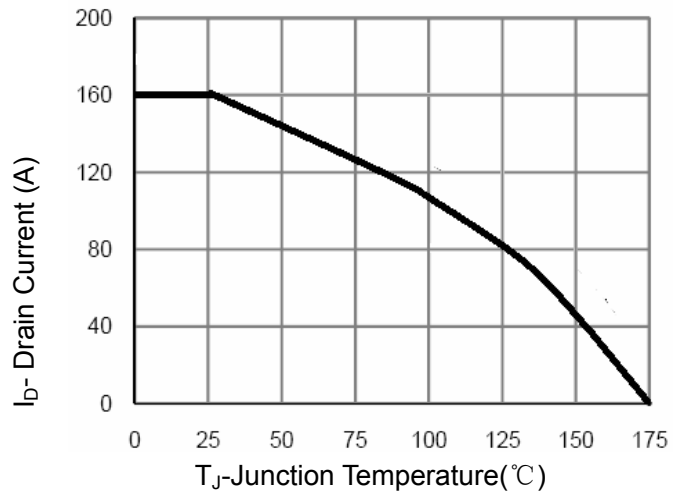
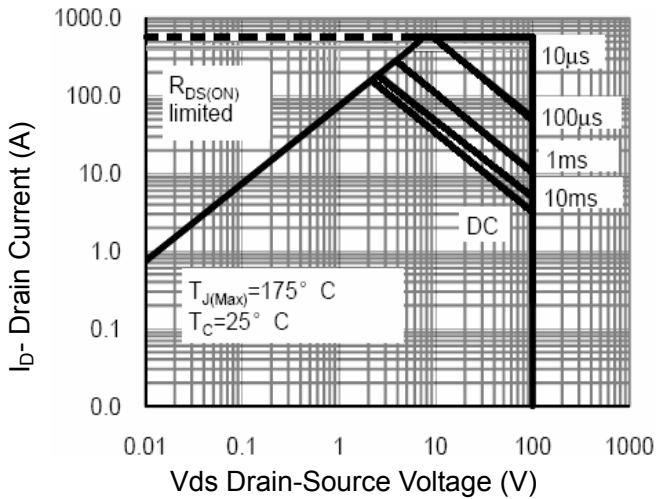
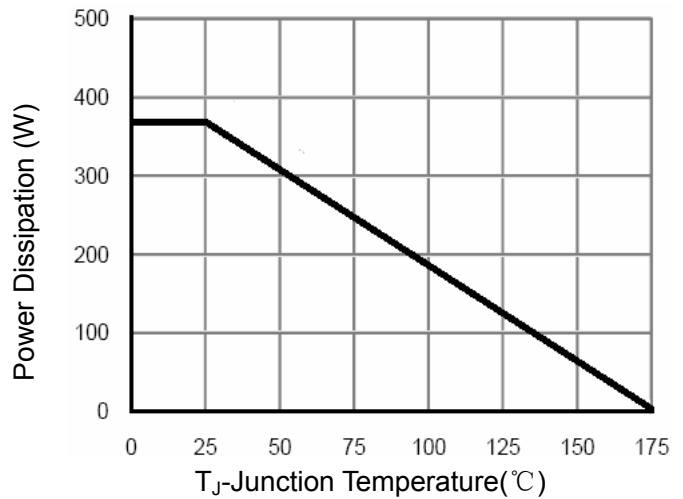
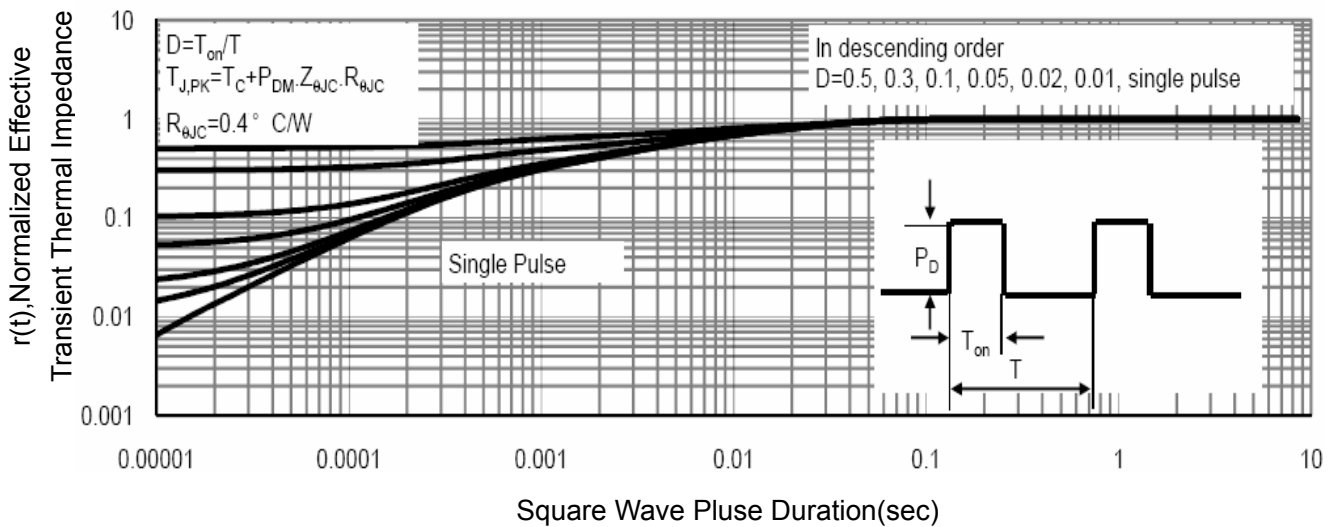
**Figure 1 Output Characteristics**

**Figure 2 Transfer Characteristics**

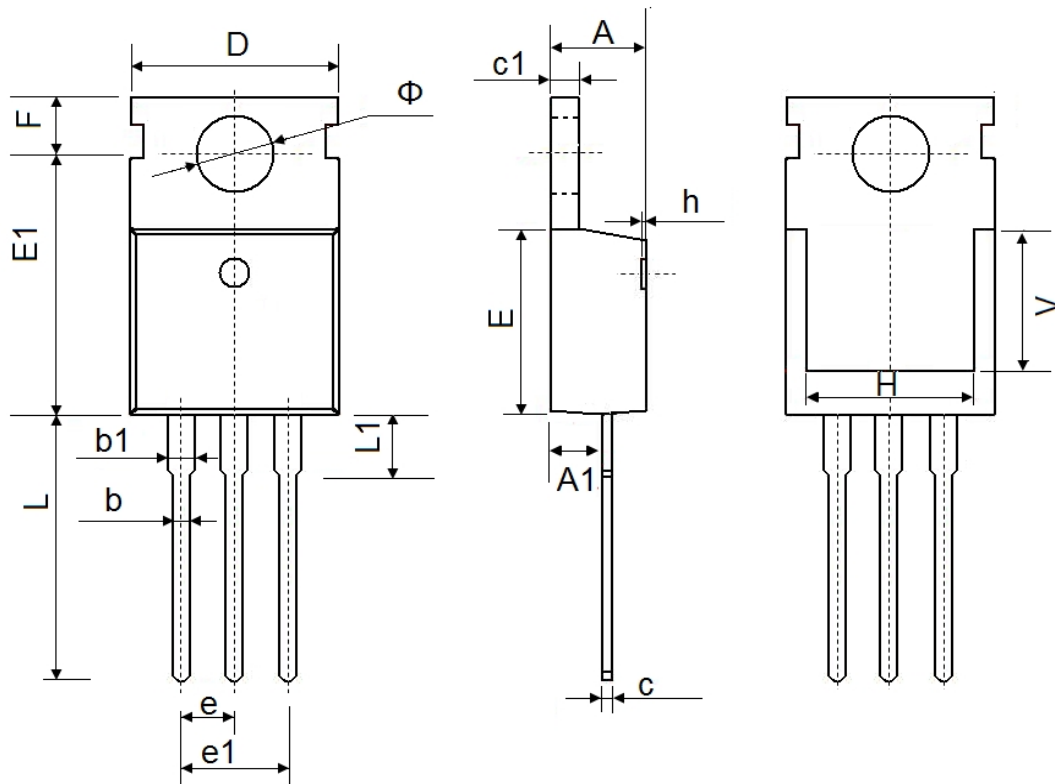
**Figure 3 Rdson- Drain Current**

**Figure 4 Rdson-Junction Temperature**

**Figure 5 Gate Charge**

**Figure 6 Source- Drain Diode Forward**

**Figure 7 Capacitance vs Vds**

**Figure 9 ID Current- Junction Temperature**

**Figure 8 Safe Operation Area**

**Figure 10 Power De-rating**

**Figure 11 Normalized Maximum Transient Thermal Impedance**

## TO-220 Package Information



Symbol	Dimensions In Millimeters		Dimensions In Inches	
	Min.	Max.	Min.	Max.
A	4.400	4.600	0.173	0.181
A1	2.250	2.550	0.089	0.100
b	0.710	0.910	0.028	0.036
b1	1.170	1.370	0.046	0.054
c	0.330	0.650	0.013	0.026
c1	1.200	1.400	0.047	0.055
D	9.910	10.250	0.390	0.404
E	8.9500	9.750	0.352	0.384
E1	12.650	12.950	0.498	0.510
e	2.540 TYP.		0.100TYP.	
e1	4.980	5.180	0.196	0.204
F	2.650	2.950	0.104	0.116
H	7.900	8.100	0.311	0.319
h	0.000	0.300	0.000	0.012
L	12.900	13.400	0.508	0.528
L1	2.850	3.250	0.112	0.128
V	7.500 REF.		0.295 REF.	
Φ	3.400	3.800	0.134	0.150

**Disclaimer:**

- FNK reserves the right to make changes to the information herein for the improvement of the design and performance without further notice! Customers should obtain the latest relevant information before placing orders and should verify that such information is complete and current.
- All semiconductor products malfunction or fail with some probability under special conditions. When using FNK products in system design or complete machine manufacturing, it is the responsibility of the buyer to comply with the safety standards strictly and take essential measures to avoid situations in which a malfunction or failure of such Silan products could cause loss of body injury or damage to property.
- FNK will supply the best possible product for customers!