

FNK N-Channel Enhancement Mode Power MOSFET

Description

The FNK01N17T uses advanced trench technology and design to provide excellent $R_{DS(ON)}$ with low gate charge. It can be used in a wide variety of applications.

General Features

- $V_{DS} = 100V, I_D = 170A$
 $R_{DS(ON)} < 5.0m\Omega @ V_{GS} = 10V$ (Typ: 4.1m Ω)
- High density cell design for ultra low Rdson
- Fully characterized avalanche voltage and current
- Good stability and uniformity with high E_{AS}
- Excellent package for good heat dissipation
- Special process technology for high ESD capability

Application

- Power switching application
- Load switching
- Uninterruptible power supply

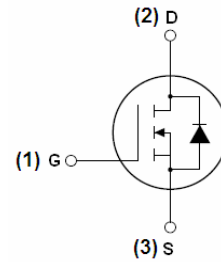

Schematic diagram

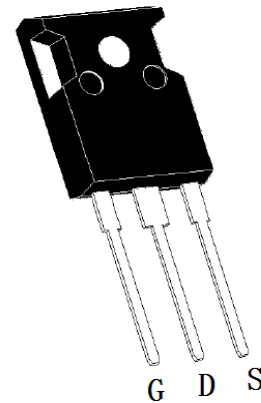

TO-247 top view

Package Marking and Ordering Information

Device Marking	Device	Device Package	Reel Size	Tape width	Quantity
FNK01N17T	FNK01N17T	TO-247	-	-	-

Absolute Maximum Ratings ($T_C = 25^\circ C$ unless otherwise noted)

Parameter	Symbol	Limit	Unit
Drain-Source Voltage	V_{DS}	100	V
Gate-Source Voltage	V_{GS}	± 20	V
Drain Current-Continuous	I_D	170	A
Drain Current-Continuous ($T_C = 100^\circ C$)	$I_D(100^\circ C)$	113	A
Pulsed Drain Current	I_{DM}	680	A
Maximum Power Dissipation	P_D	370	W
Derating factor		2.5	W/ $^\circ C$
Single pulse avalanche energy ^(Note 5)	E_{AS}	635	mJ

Parameter	Symbol	Limit	Unit
Operating Junction and Storage Temperature Range	T_J, T_{STG}	-55 To 175	°C

Thermal Characteristic

Thermal Resistance, Junction-to-Case ^(Note 2)	$R_{\theta JC}$	0.4	°C/W
--	-----------------	-----	------

Electrical Characteristics ($T_C=25^\circ\text{C}$ unless otherwise noted)

Parameter	Symbol	Condition	Min	Typ	Max	Unit
Off Characteristics						
Drain-Source Breakdown Voltage	BV_{DSS}	$V_{GS}=0V, I_D=250\mu A$	100	-	-	V
Zero Gate Voltage Drain Current	I_{DSS}	$V_{DS}=100V, V_{GS}=0V$	-	-	1	μA
Gate-Body Leakage Current	I_{GSS}	$V_{GS}=\pm 20V, V_{DS}=0V$	-	-	±100	nA
On Characteristics ^(Note 3)						
Gate Threshold Voltage	$V_{GS(th)}$	$V_{DS}=V_{GS}, I_D=250\mu A$	2	3.1	4	V
Drain-Source On-State Resistance	$R_{DS(on)}$	$V_{GS}=10V, I_D=20A$	-	4.1	5.0	mΩ
Forward Transconductance	g_{FS}	$V_{DS}=5V, I_D=20A$	70	-	-	S
Dynamic Characteristics ^(Note 4)						
Input Capacitance	C_{iss}	$V_{DS}=25V, V_{GS}=0V,$ $F=1.0\text{MHz}$	-	7895	-	PF
Output Capacitance	C_{oss}		-	900	-	PF
Reverse Transfer Capacitance	C_{rss}		-	562	-	PF
Switching Characteristics ^(Note 4)						
Turn-on Delay Time	$t_{d(on)}$	$V_{DD}=50V, R_L=2.5\Omega$ $V_{GS}=10V, R_{GEN}=3\Omega$	-	28	-	nS
Turn-on Rise Time	t_r		-	22	-	nS
Turn-Off Delay Time	$t_{d(off)}$		-	43.5	-	nS
Turn-Off Fall Time	t_f		-	14.5	-	nS
Total Gate Charge	Q_g	$V_{DS}=50V, I_D=20A,$ $V_{GS}=10V$	-	139	-	nC
Gate-Source Charge	Q_{gs}		-	34	-	nC
Gate-Drain Charge	Q_{gd}		-	56	-	nC
Drain-Source Diode Characteristics						
Diode Forward Voltage ^(Note 3)	V_{SD}	$V_{GS}=0V, I_S=20A$	-	0.85	1.2	V
Diode Forward Current ^(Note 2)	I_S		-	-	160	A
Reverse Recovery Time	t_{rr}	$T_J = 25^\circ\text{C}, I_F = 20A$ $di/dt = 100A/\mu s$ ^(Note 3)	-	60	90	nS
Reverse Recovery Charge	Q_{rr}		-	177	200	nC

Notes:

1. Repetitive Rating: Pulse width limited by maximum junction temperature.
2. Surface Mounted on FR4 Board, $t \leq 10$ sec.
3. Pulse Test: Pulse Width $\leq 300\mu s$, Duty Cycle $\leq 2\%$.
4. Guaranteed by design, not subject to production
5. EAS condition: $T_J=25^\circ\text{C}, V_{DD}=50V, V_G=10V, L=1\text{mH}, R_g=25\Omega$

Test Circuit
1) E_{AS} test Circuit

2) Gate charge test Circuit

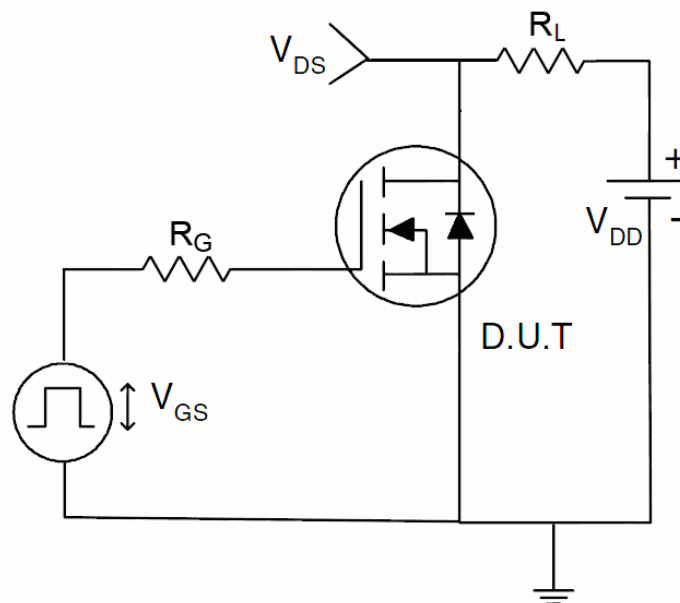
3) Switch Time Test Circuit

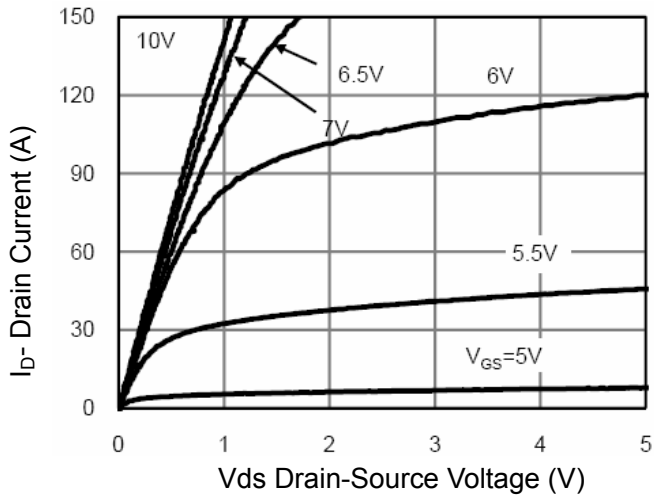
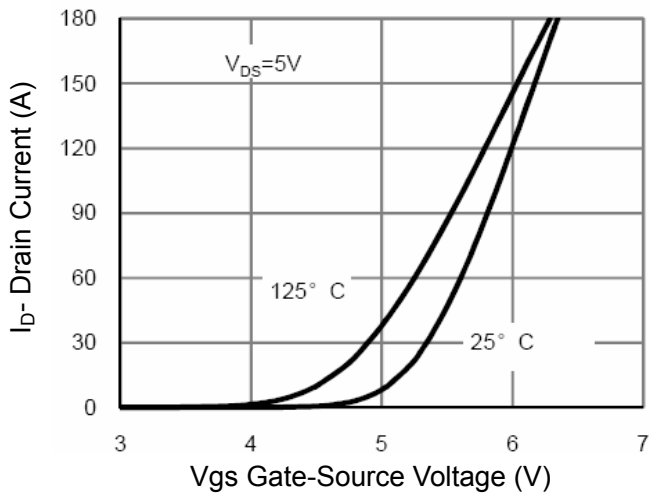
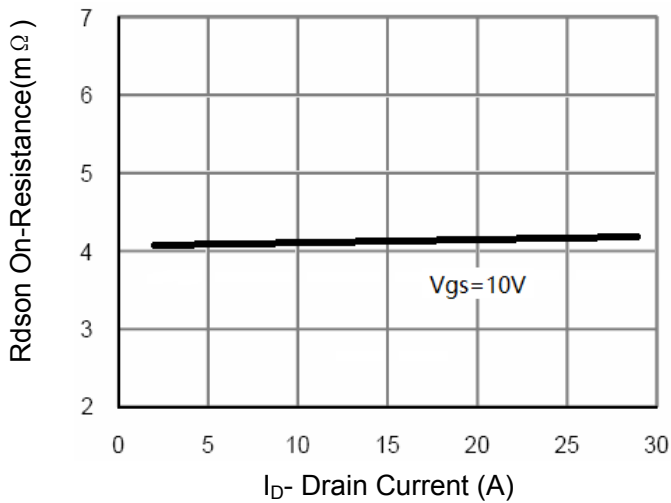
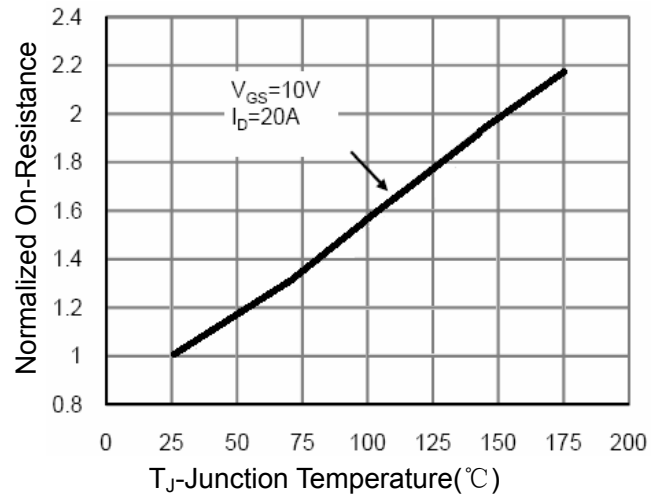
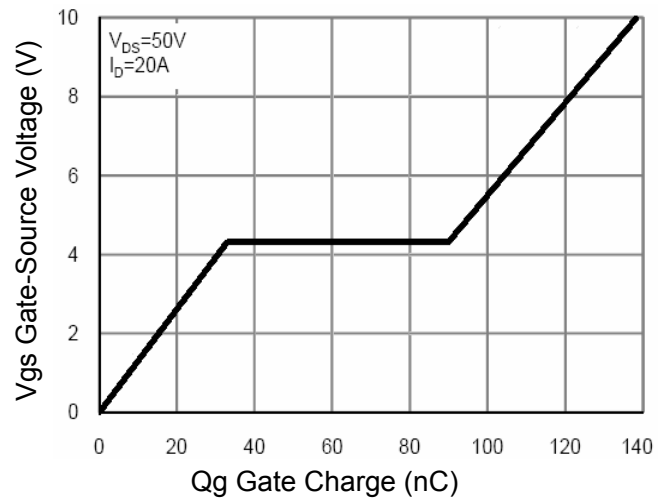
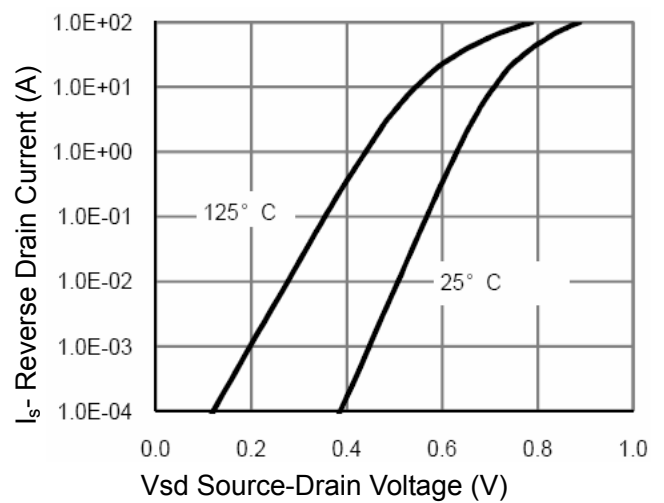
Typical Electrical and Thermal Characteristics (Curves)

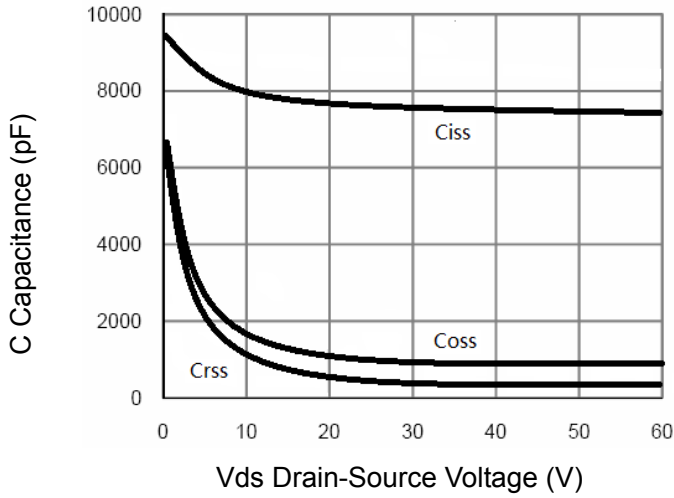
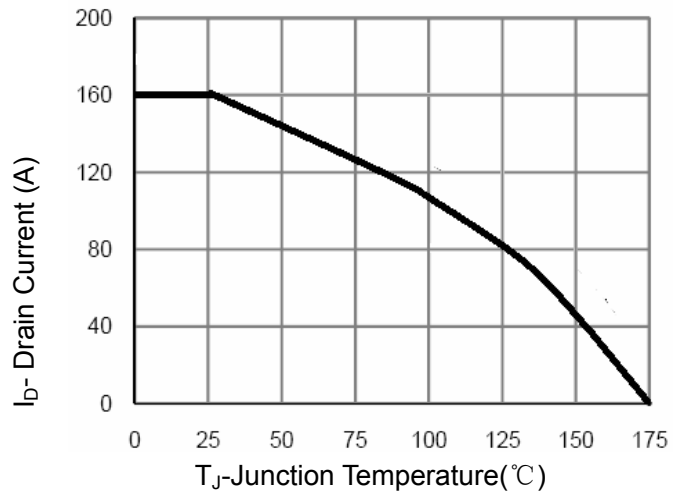
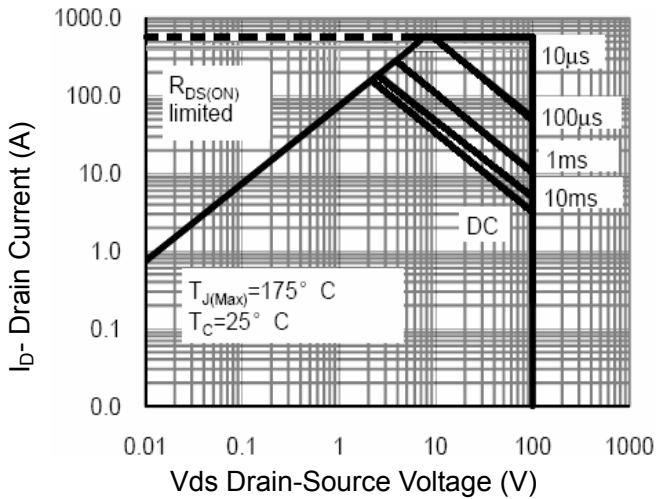
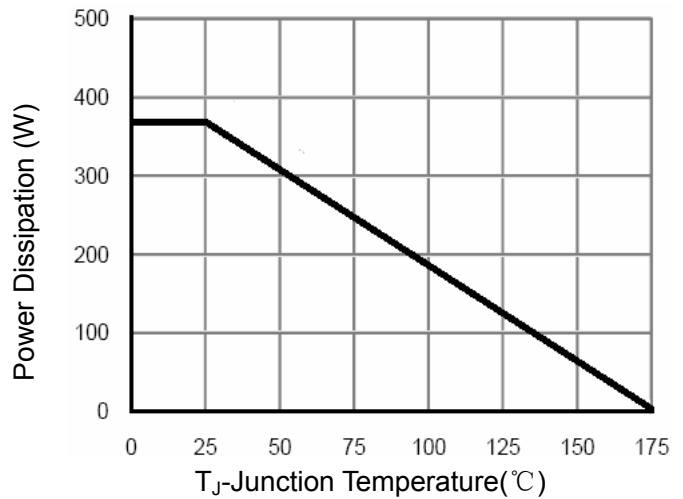
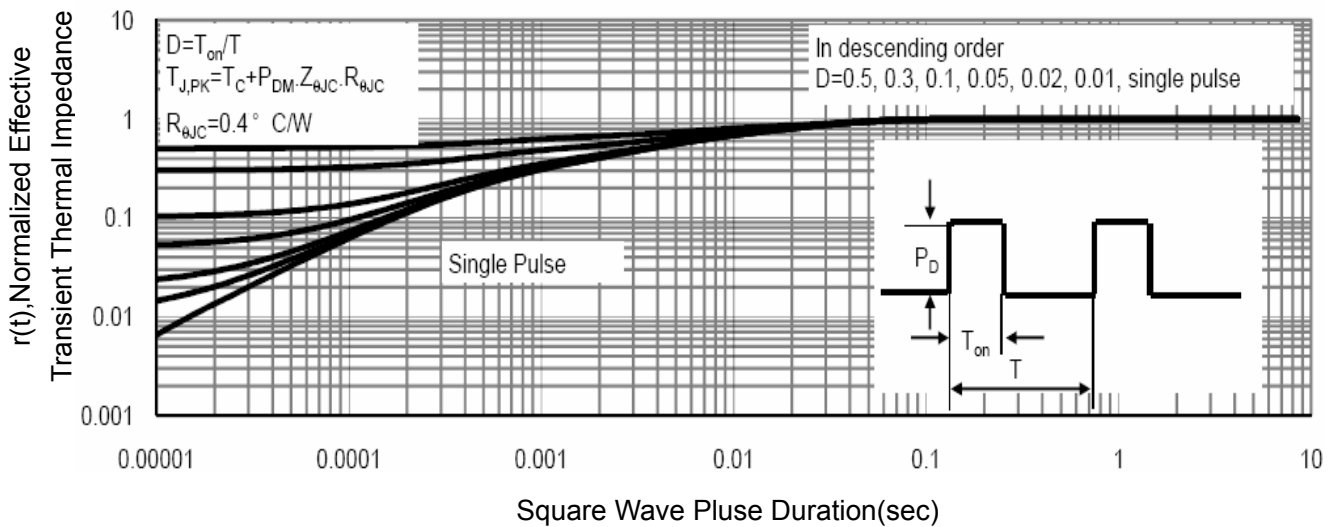
Figure 1 Output Characteristics

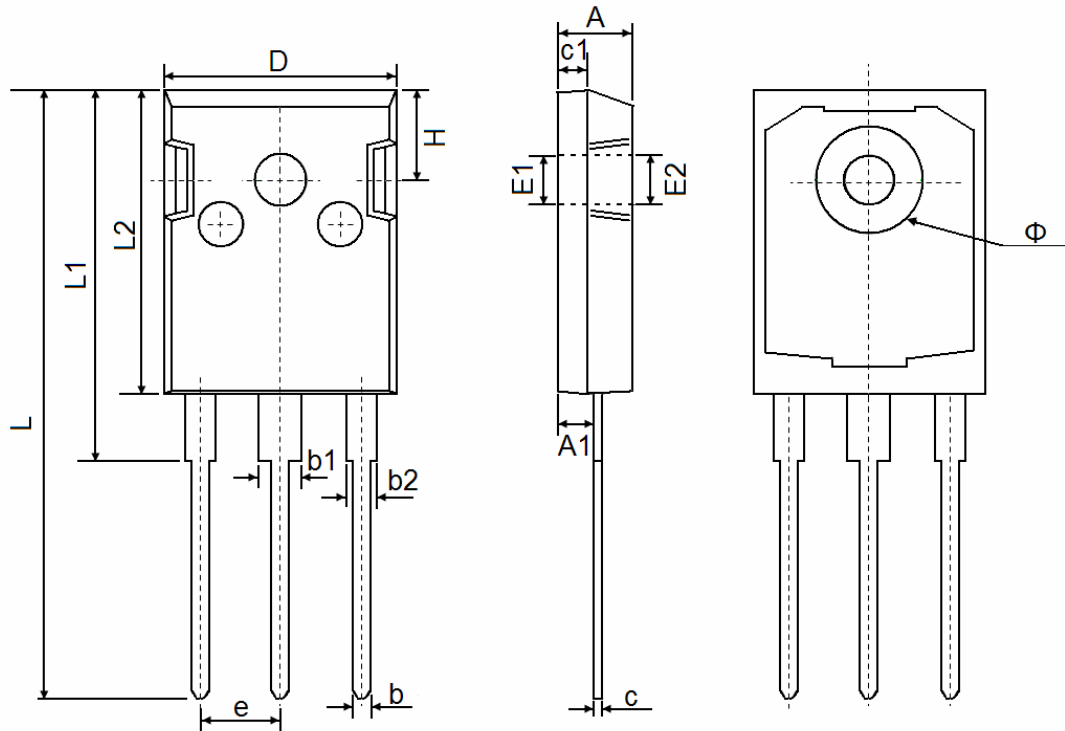
Figure 2 Transfer Characteristics

Figure 3 $R_{DS(on)}$ - Drain Current

Figure 4 $R_{DS(on)}$ -Junction Temperature

Figure 5 Gate Charge

Figure 6 Source- Drain Diode Forward

Figure 7 Capacitance vs Vds

Figure 9 ID Current- Junction Temperature

Figure 8 Safe Operation Area

Figure 10 Power De-rating

Figure 11 Normalized Maximum Transient Thermal Impedance

TO-247 Package Information

Symbol	Dimensions In Millimeters		Dimensions In Inches	
	Min.	Max.	Min.	Max.
A	4.850	5.150	0.191	0.200
A1	2.200	2.600	0.087	0.102
b	1.000	1.400	0.039	0.055
b1	2.800	3.200	0.110	0.126
b2	1.800	2.200	0.071	0.087
c	0.500	0.700	0.020	0.028
c1	1.900	2.100	0.075	0.083
D	15.450	15.750	0.608	0.620
E1	3.500 REF		0.138 REF	
E2	3.600 REF		0.142 REF	
L	40.900	41.300	1.610	1.626
L1	24.800	25.100	0.976	0.988
L2	20.300	20.600	0.799	0.811
Φ	7.100	7.300	0.280	0.287
e	5.450 TYP		0.215 TYP	
H	5.980 REF		0.235 REF	

Disclaimer:

- FNK reserves the right to make changes to the information herein for the improvement of the design and performance without further notice! Customers should obtain the latest relevant information before placing orders and should verify that such information is complete and current.
- All semiconductor products malfunction or fail with some probability under special conditions. When using FNK products in system design or complete machine manufacturing, it is the responsibility of the buyer to comply with the safety standards strictly and take essential measures to avoid situations in which a malfunction or failure of such Silan products could cause loss of body injury or damage to property.
- FNK will supply the best possible product for customers!