

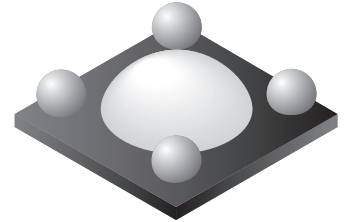
**FODB100**

**FODB101**

**FODB102**

**DESCRIPTION**

The FODB100, FODB101 and FODB102 single channel MICROCOUPLERS™ are all Pb-free, low profile miniature surface mount optocouplers in a Ball Grid Array (BGA) package. Each consists of an aluminum gallium arsenide (AlGaAs) infrared emitting diode driving a silicon phototransistor.



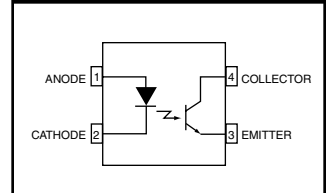
**FEATURES**

- Low profile package (1.20mm maximum mounted height)
- Land pattern allows for optimum board space savings
- High Current Transfer Ratio (CTR) at low IF
- Minimum isolation distance of 0.45mm
- High steady state isolation voltage of 2500V<sub>rms</sub>
- Data rates up to 120Kbit/s (NRZ)
- Minimum creepage distance of 2mm
- Wide operating temperature range of -40°C to +125°C
- Available in tape and reel quantities of 3000 units
- Applicable to Pb-free Infrared Ray reflow (260°C max)
- UL, C-UL approved; VDE pending

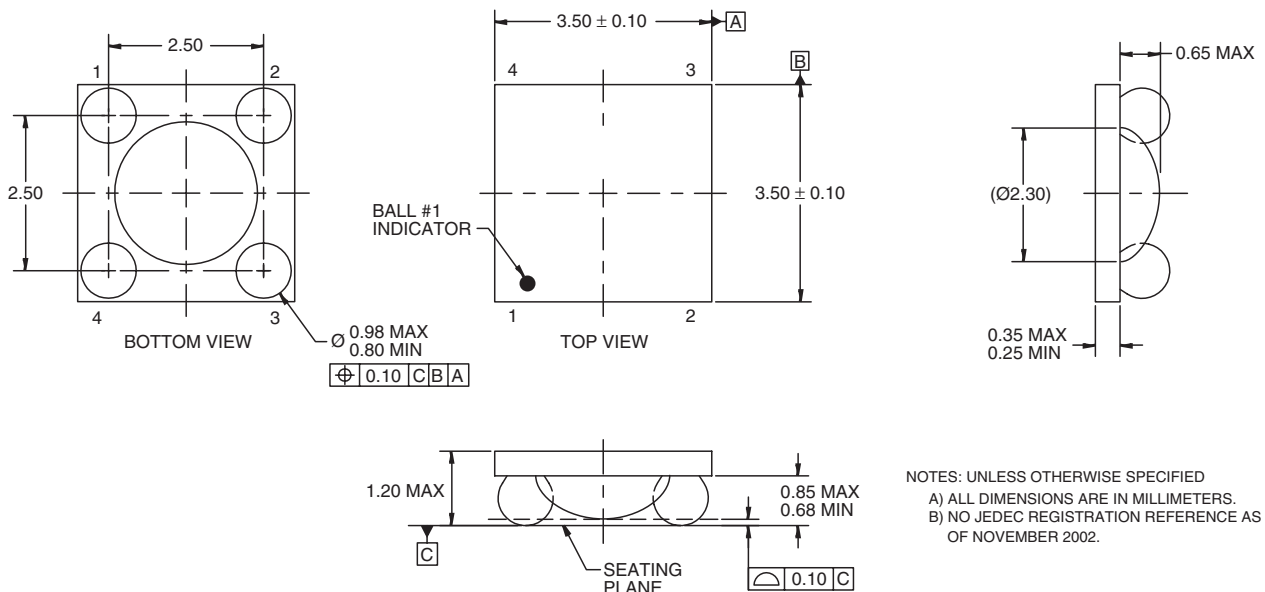
**APPLICATIONS**

- Primarily suited for DC-DC converters
- For ground loop isolation, signal to noise isolation
  - Communications – chargers, adapters
  - Consumer – appliances, set top boxes
  - Industrial – power supplies, motor control

**SCHEMATIC**



**PACKAGE DIMENSIONS**



**FODB100**

**FODB101**

**FODB102**

<b>ABSOLUTE MAXIMUM RATINGS</b> ( $T_A = 25^\circ\text{C}$ unless otherwise specified)			
Parameter	Symbol	Value	Units
<b>TOTAL PACKAGE</b>			
Storage Temperature	$T_{STG}$	-55 to +150	$^\circ\text{C}$
Operating Temperature	$T_{OPR}$	-40 to +125	$^\circ\text{C}$
Junction Temperature	$T_j$	130	$^\circ\text{C}$
<b>EMITTER</b>			
Continuous Forward Current	$I_F$ (avg)	30	mA
Reverse Input Voltage	$V_R$	6	V
Power Dissipation Derate linearly (above $25^\circ\text{C}$ )	$P_D$	40	mW
		0.39	mW/ $^\circ\text{C}$
<b>DETECTOR</b>			
Continuous Collector Current		50	mA
Power Dissipation Derate linearly (above $25^\circ\text{C}$ )	$P_D$	150	mW
		1.42	mW/ $^\circ\text{C}$
Collector-Emitter Voltage	$V_{CEO}$	75	V
Emitter-Collector Voltage	$V_{ECO}$	7	V

<b>ELECTRICAL CHARACTERISTICS</b> ( $T_A = 25^\circ\text{C}$ )						
<b>INDIVIDUAL COMPONENT CHARACTERISTICS</b>						
Parameter	Test Conditions	Symbol	Min	Typ**	Max	Unit
<b>EMITTER</b>						
Forward Voltage	( $I_F = 2\text{ mA}$ )	$V_F$	1.0		1.5	V
Reverse Current	( $V_R = 6\text{ V}$ )	$I_R$			10	$\mu\text{A}$
<b>DETECTOR</b>						
Breakdown Voltage Collector to Emitter	( $I_C = 100\ \mu\text{A}$ , $I_F = 0$ )	$BV_{CEO}$	75			V
Emitter to Collector	( $I_E = 100\ \mu\text{A}$ , $I_F = 0$ )	$BV_{ECO}$	7			
Collector Dark Current	( $V_{CE} = 75\text{ V}$ , $I_F = 0$ )	$I_{CEO}$			100	nA
Capacitance	( $V_{CE} = 0\text{ V}$ , $f = 1\text{ MHz}$ )	$C_{CE}$		8		pF

**FODB100**

**FODB101**

**FODB102**

<b>TRANSFER CHARACTERISTICS</b> ( $T_A = 25^\circ\text{C}$ )						
Characteristic	Test Conditions	Symbol	Min	Typ**	Max	Unit
Current Transfer Ratio <sup>1</sup>	( $I_F = 1\text{ mA}$ , $V_{CE} = 5\text{ V}$ )	CTR	100			%
Saturated Current Transfer Ratio (Collector to Emitter)	( $I_F = 1.6\text{ mA}$ , $V_{CE} = 0.4\text{ V}$ )	CTR <sub>CE(SAT)</sub>	100			%
	( $I_F = 1.0\text{ mA}$ , $V_{CE} = 0.4\text{ V}$ )		75			
Saturation Voltage	( $I_F = 3.0\text{ mA}$ , $I_C = 1.8\text{ mA}$ ) ( $I_F = 1.6\text{ mA}$ , $I_C = 1.6\text{ mA}$ )	$V_{CE(SAT)}$			0.4	V
Rise Time (Non-Saturated)	( $I_C = 2\text{ mA}$ , $V_{CE} = 5\text{ V}$ ) ( $R_L = 1\text{ K}\Omega$ )	$t_r$		1		$\mu\text{s}$
Fall Time (Non-Saturated)	( $I_C = 2\text{ mA}$ , $V_{CE} = 5\text{ V}$ ) ( $R_L = 1\text{ K}\Omega$ )	$t_f$		5		
Propagation Delay High to Low	$I_F = 1.6\text{ mA}$ , $V_{CC} = 5.0\text{ V}$ $R_L = 750\Omega$	$T_{PHL}$		3		$\mu\text{s}$
	$I_F = 1.6\text{ mA}$ , $V_{CC} = 5.0\text{ V}$ $R_L = 4.7\text{ K}\Omega$			12		
Propagation Delay Low to High	$I_F = 1.6\text{ mA}$ , $V_{CC} = 5.0\text{ V}$ $R_L = 750\Omega$	$T_{PLH}$		5		$\mu\text{s}$
	$I_F = 1.6\text{ mA}$ , $V_{CC} = 5.0\text{ V}$ $R_L = 4.7\text{ K}\Omega$			19		

<b>ISOLATION CHARACTERISTICS</b>						
Characteristic	Test Conditions	Symbol	Min	Typ**	Max	Unit
Steady State Isolation Voltage <sup>2</sup>	( $R_H \leq 50\%$ , $T_A = 25^\circ\text{C}$ , $t = 1\text{ sec}$ )	$V_{ISO}$	2500			V(rms)
Resistance (input to output) <sup>2</sup>	( $V_{I-O} = 500\text{ VDC}$ )	$R_{ISO}$	$10^{12}$			$\Omega$
Capacitance (input to output) <sup>2</sup>	$f = 1\text{ MHz}$	$C_{ISO}$		0.3	0.5	pF

Notes:

1. CTR bin (FODB100 only)

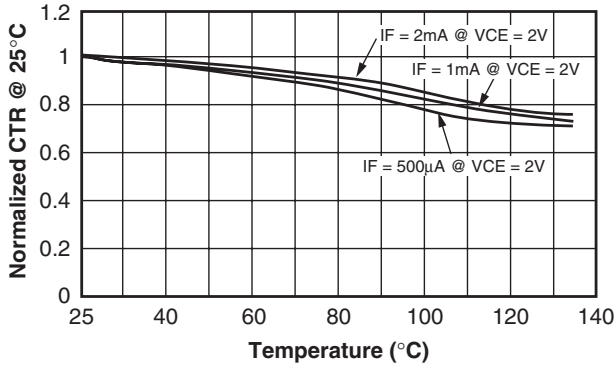
FODB101: 100% – 200%

FODB102: 150% – 300%

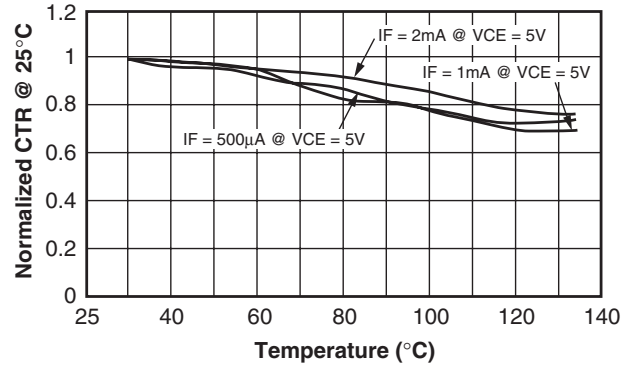
2. Pin 1 and Pin 2 are shorted as input and Pin 3 and Pin 4 are shorted as output.

**TYPICAL PERFORMANCE CURVES**

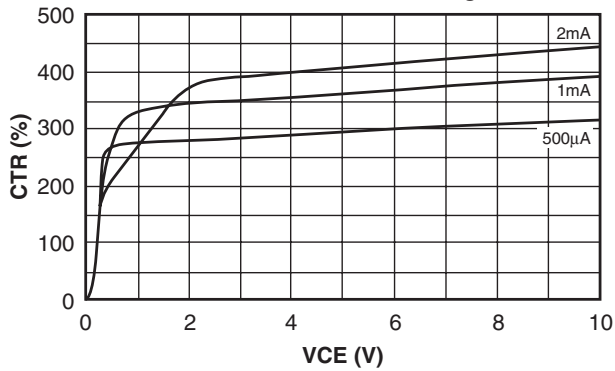
**Fig. 1 Normalized CTR vs. Temperature (VCE = 2V)**



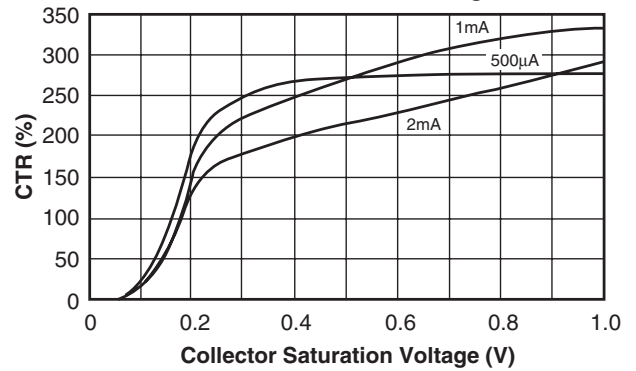
**Fig. 2 Normalized CTR vs. Temperature (VCE = 5V)**



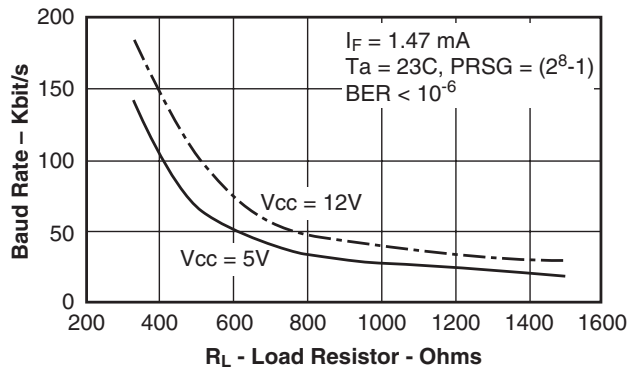
**Fig. 3 Current Transfer Ratio vs. Collector to Emitter Voltage**



**Fig. 4 Current Transfer Ratio vs. Collector Saturation Voltage**

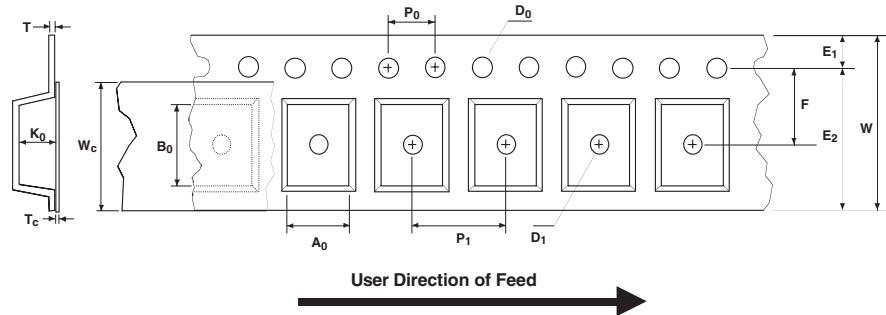


**Fig. 5 Baud Rate vs. Load Resistor**



**TAPE AND REEL SPECIFICATIONS**

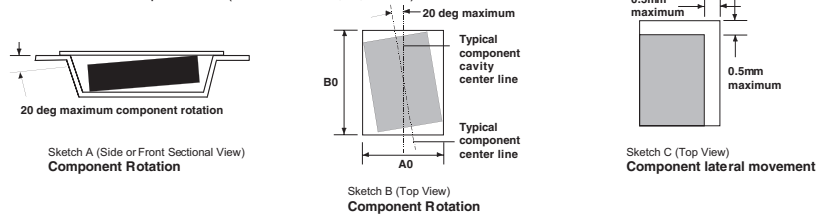
**Embossed Carrier Tape Configuration**



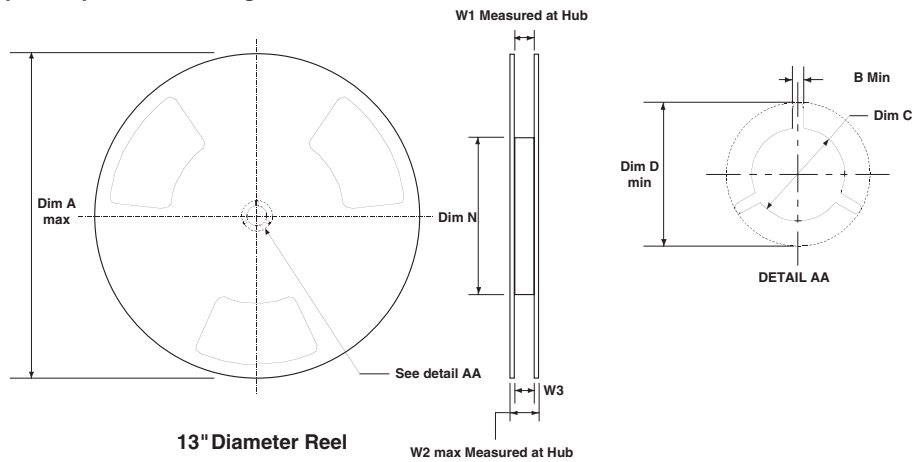
Dimensions are in millimeter

Pkg type	A <sub>0</sub>	B <sub>0</sub>	W	D <sub>0</sub>	D <sub>1</sub>	E <sub>1</sub>	E <sub>2</sub>	F	P <sub>1</sub>	P <sub>0</sub>	K <sub>0</sub>	T	W <sub>c</sub>	T <sub>c</sub>
Optocoupler (12mm)	3.80 ±0.10	3.80 ±0.10	12.0 +0.3/-0.1	1.50 +0.25/-0.00	1.50 +0.25/-0.00	1.75 ±0.10	10.25 min	5.50 ±0.05	8.0 ±0.1	4.0 ±0.1	1.40 ±0.10	0.279 ±0.02	9.2 ±0.3	0.06 ±0.02

Notes: A<sub>0</sub>, B<sub>0</sub>, and K<sub>0</sub> dimensions are determined with respect to the EIA/Jedec RS-481 rotational and lateral movement requirements (see sketches A, B, and C).



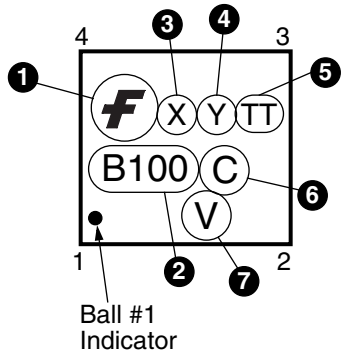
**Optocoupler Reel Configuration**



Dimension are in inches and millimeters

Tape Size	Reel Option	Dim A	Dim B	Dim C	Dim D	Dim N	Dim W1	Dim W2	Dim W3 (LSL-USL)
12mm	13" Dia	13.00 330	0.059 1.5	512 +0.020/-0.008 13 +0.5/-0.2	0.795 20.2	7.00 178	0.488 +0.078/-0.000 12.4 +2/-0	0.724 18.4	0.469 - 0.606 11.9 - 15.4

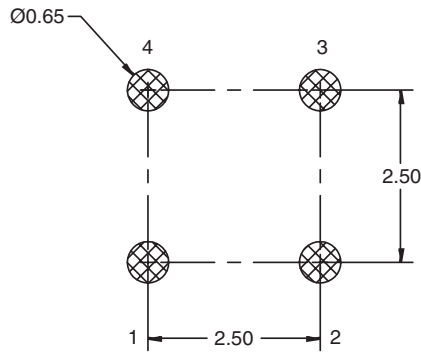
**MARKING INFORMATION**



Definitions	
1	Fairchild logo
2	Device number (FODB100)
3	One digit year code e.g. "4" for 2004
4	6-week date code character
5	Die Run Code
6	Assembly package code
7	VDE 0884 approved (Optional)

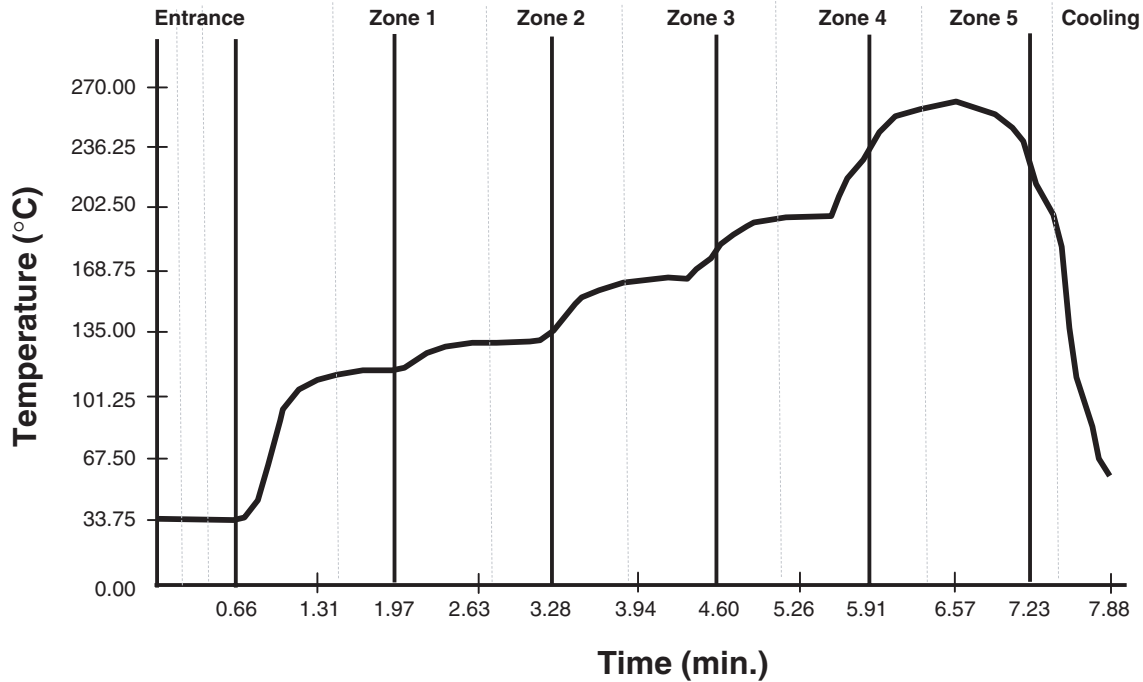
**Note:** The device number prefix of "FOD" will be omitted in the part number

**RECOMMENDED FOOTPRINT DRAWING FOR PCB LAYOUT**



**Note:**  
1. All dimensions in millimeters (mm)  
2. It is recommended to use 6 mils of stencil thickness on PCB

**RECOMMENDED INFRARED REFLOW SOLDERING PROFILE**



**Reflow Profile for Pb Free**

	Convection Reflow
Average ramp-up rate (183°C to peak)	3°C/sec max
Preheat Temperature 125(±25)°C to 200°C	60-180°C
Temperature maintained above 220°C	60-150 sec
Time within 5°C of actual peak temperature	20-40 sec
Peak temperature range	260 ±5°C
Ramp down rate	6°C/sec max
Time 25°C to peak temperature	8min max

Note: Surface Mount Adhesives (SMA) isn't recommended to be used on the dome area (white dome).

---

**FODB100**

**FODB101**

**FODB102**

---

**DISCLAIMER**

FAIRCHILD SEMICONDUCTOR RESERVES THE RIGHT TO MAKE CHANGES WITHOUT FURTHER NOTICE TO ANY PRODUCTS HEREIN TO IMPROVE RELIABILITY, FUNCTION OR DESIGN. FAIRCHILD DOES NOT ASSUME ANY LIABILITY ARISING OUT OF THE APPLICATION OR USE OF ANY PRODUCT OR CIRCUIT DESCRIBED HEREIN; NEITHER DOES IT CONVEY ANY LICENSE UNDER ITS PATENT RIGHTS, NOR THE RIGHTS OF OTHERS.

**LIFE SUPPORT POLICY**

FAIRCHILD'S PRODUCTS ARE NOT AUTHORIZED FOR USE AS CRITICAL COMPONENTS IN LIFE SUPPORT DEVICES OR SYSTEMS WITHOUT THE EXPRESS WRITTEN APPROVAL OF THE PRESIDENT OF FAIRCHILD SEMICONDUCTOR CORPORATION. As used herein:

1. Life support devices or systems are devices or systems which, (a) are intended for surgical implant into the body, or (b) support or sustain life, and (c) whose failure to perform when properly used in accordance with instructions for use provided in the labeling, can be reasonably expected to result in a significant injury of the user.
2. A critical component in any component of a life support device or system whose failure to perform can be reasonably expected to cause the failure of the life support device or system, or to affect its safety or effectiveness.