

# FP1309B

## High frequency, high current power inductors



### Applications

- Servers
- Multi-phase and Vcore regulators
- Voltage Regulator Modules (VRMs)
  - Server and desktop
  - Central processing unit (CPU)
  - Graphics processing unit (GPU)
  - Application specific integrated circuit (ASIC)
  - High power density
- Data centers, networking and storage systems
- Point-of-Load modules
- DCR Sensing circuits

### Product description

- High current carrying capacity
- Low core loss
- Tight tolerance DCR for sensing circuits
- Inductance Range from 100nH to 150nH
- Current range from 60 to 100 amps
- 12.8 x 8.3mm footprint surface mount package in an 8.8mm height
- Ferrite core material
- Halogen free, lead free, RoHS compliant

### Environmental data

- Storage temperature range (Component): -40°C to +125°C
- Operating temperature range: -40°C to +125°C (ambient + self-temperature rise)
- Solder reflow temperature: J-STD-020D compliant



Product specifications

Part Number <sup>7</sup>	OCL <sup>1</sup> (nH)±10%	FLL <sup>2</sup> (nH) minimum	I <sub>rms</sub> <sup>3</sup> (amps)	I <sub>sat</sub> 1 <sup>4</sup> (amps)	I <sub>sat</sub> 2 <sup>5</sup> (amps)	DCR (mΩ) ±5% @ 20°C	K-factor <sup>6</sup>
<b>B1 version</b>							
FP1309B1-R100-R	100	72	60	100	80	0.19	296
FP1309B1-R120-R	120	87	60	90	72	0.19	296
FP1309B1-R150-R	150	108	60	80	64	0.19	296

- Open Circuit Inductance (OCL) Test Parameters: 100kHz, 0.1Vrms, 0.0Adc, +25°C
- Full Load Inductance (FLL) Test Parameters: 100kHz, 0.1Vrms, I<sub>sat</sub>1, +25°C
- I<sub>rms</sub>: DC current for an approximate temperature rise of 40°C without core loss. Derating is necessary for AC currents. PCB layout, trace thickness and width, air-flow, and proximity of other heat generating components will affect the temperature rise. It is recommended that the temperature of the part not exceed 125°C under worst case operating conditions verified in the end application.
- I<sub>sat</sub>1: Peak current for approximately 20% rolloff @ +25°C
- I<sub>sat</sub>2: Peak current for approximately 20% rolloff @ +125°C
- K-factor: Used to determine Bp-p for core loss (see graph). Bp-p = K \* L \* ΔI \* 10<sup>-3</sup>. Bp-p:(Gauss), K: (K-factor from table), L: (Inductance in nH), ΔI (Peak to peak ripple current in Amps).
- Part Number Definition: FP1309Bx-Rxxx-R  
FP1309B= Product code and size  
x= Version indicator  
Rxxx= Inductance value in μH, R= decimal point  
-R suffix = RoHS compliant

Dimensions (mm)

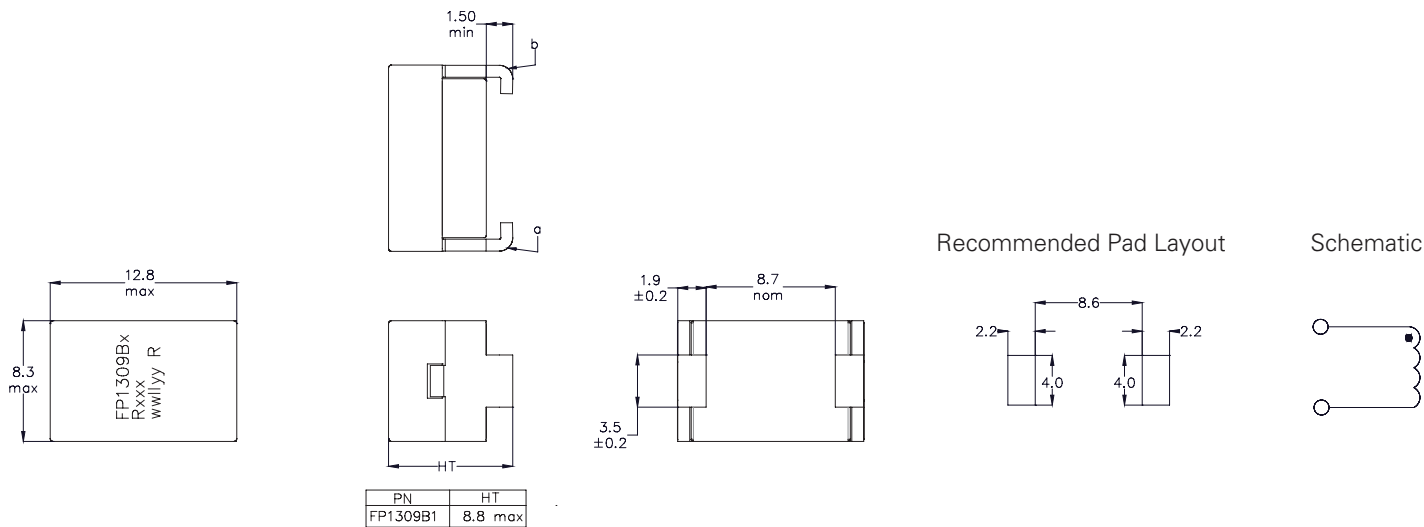

Part marking: FP1309Bx (Product code and size, x = version indicator),  
Rxxx = Inductance value in μH, R = decimal point  
wwlllyy = date code, R = revision level

All soldering surface to be coplanar within 0.10mm

DCR measured between point "a" and point "b"

**Packaging information (mm)**

Supplied in tape and reel packaging, 330 parts per 13" diameter reel

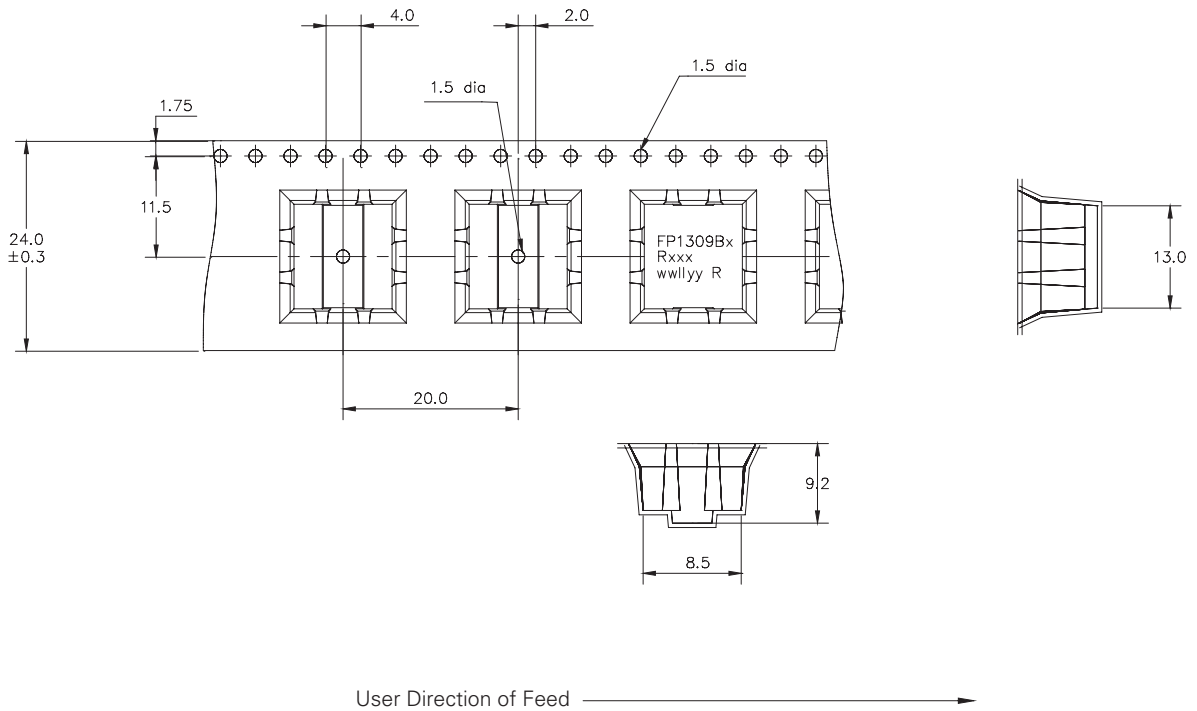

**Temperature rise vs. total loss**

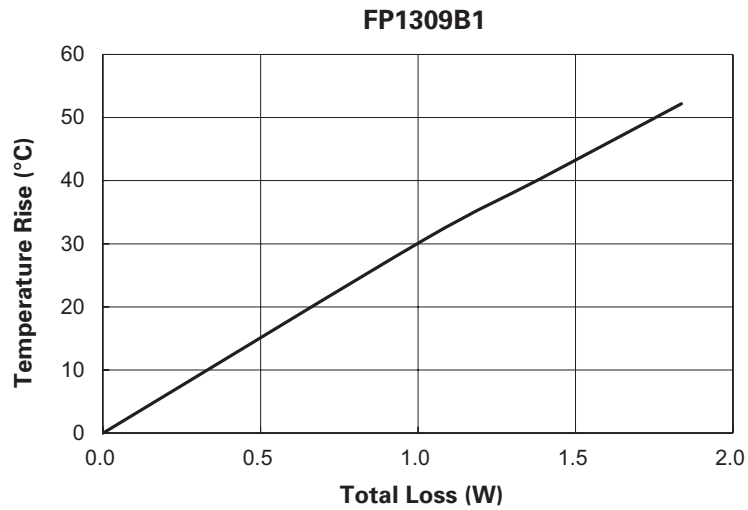

Core loss vs.  $B_{p-p}$

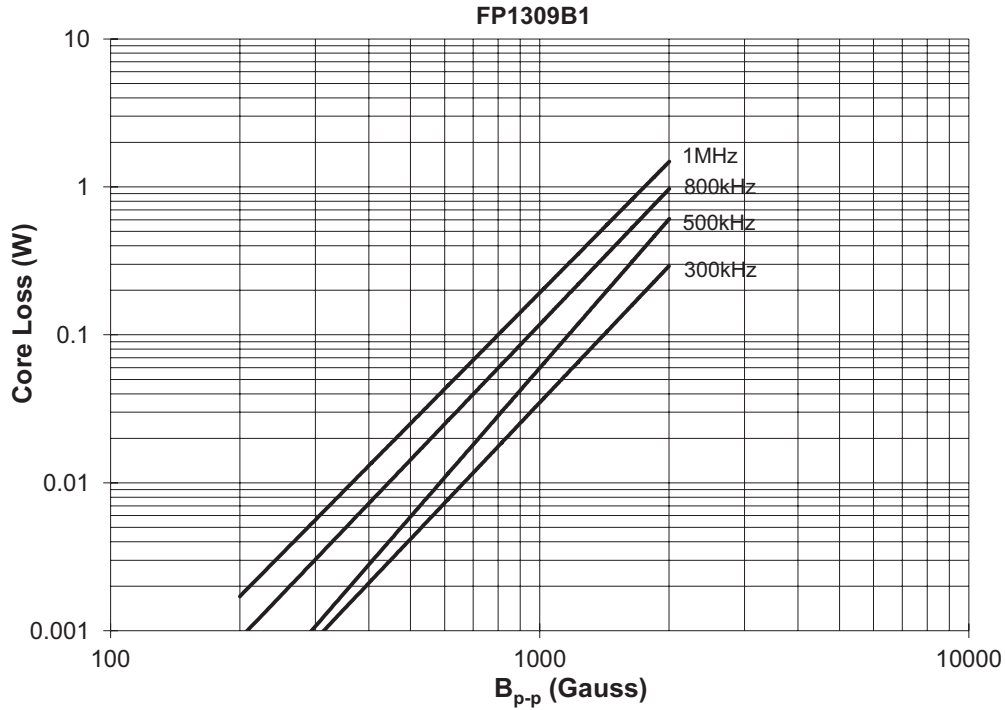

Inductance characteristics

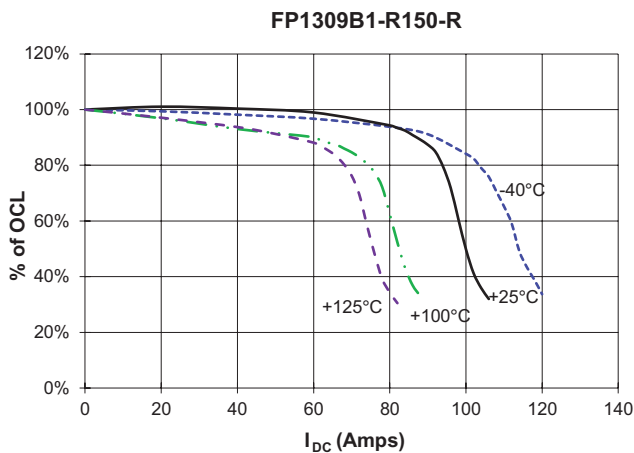
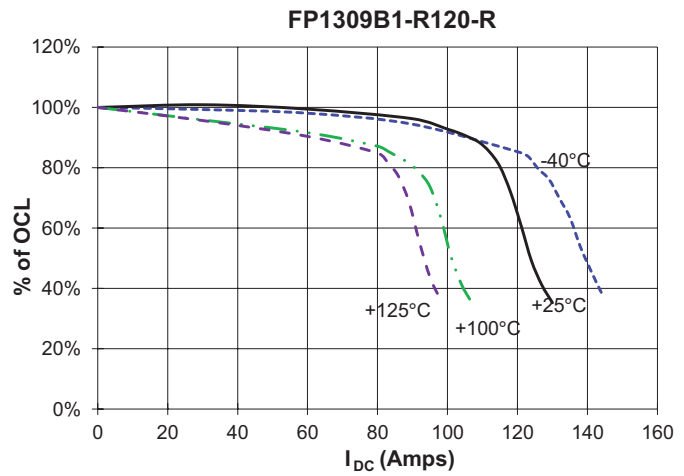
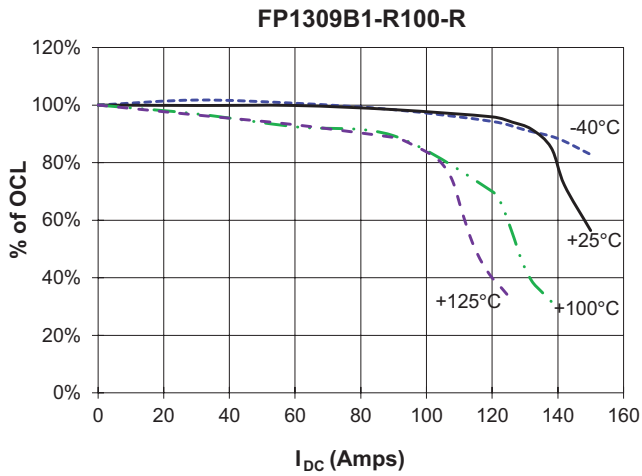

**Solder reflow profile**



**Table 1 - Standard SnPb Solder ( $T_c$ )**

Package Thickness	Volume $mm^3$ <350	Volume $mm^3$ $\geq$ 350
<2.5mm)	235°C	220°C
$\geq$ 2.5mm	220°C	220°C

**Table 2 - Lead (Pb) Free Solder ( $T_c$ )**

Package Thickness	Volume $mm^3$ <350	Volume $mm^3$ 350 - 2000	Volume $mm^3$ >2000
<1.6mm	260°C	260°C	260°C
1.6 – 2.5mm	260°C	250°C	245°C
>2.5mm	250°C	245°C	245°C

**Reference JDEC J-STD-020D**

Profile Feature	Standard SnPb Solder	Lead (Pb) Free Solder
Preheat and Soak		
• Temperature min. ( $T_{smin}$ )	100°C	150°C
• Temperature max. ( $T_{smax}$ )	150°C	200°C
• Time ( $T_{smin}$ to $T_{smax}$ ) ( $t_s$ )	60-120 Seconds	60-120 Seconds
Average ramp up rate $T_{smax}$ to $T_p$	3°C/ Second Max.	3°C/ Second Max.
Liquidous temperature ( $T_L$ )	183°C	217°C
Time at liquidous ( $t_L$ )	60-150 Seconds	60-150 Seconds
Peak package body temperature ( $T_p$ )*	Table 1	Table 2
Time ( $t_p$ )** within 5 °C of the specified classification temperature ( $T_c$ )	20 Seconds**	30 Seconds**
Average ramp-down rate ( $T_p$ to $T_{smax}$ )	6°C/ Second Max.	6°C/ Second Max.
Time 25°C to Peak Temperature	6 Minutes Max.	8 Minutes Max.

\* Tolerance for peak profile temperature ( $T_p$ ) is defined as a supplier minimum and a user maximum.  
\*\* Tolerance for time at peak profile temperature ( $t_p$ ) is defined as a supplier minimum and a user maximum.

Life Support Policy: Eaton does not authorize the use of any of its products for use in life support devices or systems without the express written approval of an officer of the Company. Life support systems are devices which support or sustain life, and whose failure to perform, when properly used in accordance with instructions for use provided in the labeling, can be reasonably expected to result in significant injury to the user.

Eaton reserves the right, without notice, to change design or construction of any products and to discontinue or limit distribution of any products. Eaton also reserves the right to change or update, without notice, any technical information contained in this bulletin.

**Eaton**  
**Electronics Division**  
1000 Eaton Boulevard  
Cleveland, OH 44122  
United States  
www.eaton.com/elx



© 2015 Eaton  
All Rights Reserved  
Printed in USA  
Publication No. 10477 BU-MC15049  
November 2015

Eaton is a registered trademark.  
All other trademarks are property of their respective owners.