

Vorläufig  
Preliminary

**Elektrische Eigenschaften / Electrical properties**

**Höchstzulässige Werte / Maximum rated values**

**Diode Gleichrichter/ Diode Rectifier**

Periodische Rückw. Spitzensperrspannung repetitive peak reverse voltage	$T_{vj} = 25^{\circ}\text{C}$	$V_{RRM}$	800	V
Durchlaßstrom Grenzeffektivwert pro Chip RMS forward current per chip	$T_C = 80^{\circ}\text{C}$	$I_{FRMSM}$	23	A
Gleichrichter Ausgang Grenzeffektivstrom maximum RMS current at Rectifier output	$T_C = 80^{\circ}\text{C}$	$I_{RMSmax}$	36	A
Stoßstrom Grenzwert surge forward current	$t_p = 10\text{ ms}, T_{vj} = 25^{\circ}\text{C}$ $t_p = 10\text{ ms}, T_{vj} = 150^{\circ}\text{C}$	$I_{FSM}$	197 158	A A
Grenzlastintegral $I^2t$ - value	$t_p = 10\text{ ms}, T_{vj} = 25^{\circ}\text{C}$ $t_p = 10\text{ ms}, T_{vj} = 150^{\circ}\text{C}$	$I^2t$	194 125	$\text{A}^2\text{s}$ $\text{A}^2\text{s}$

**Transistor Wechselrichter/ Transistor Inverter**

Kollektor-Emitter-Sperrspannung collector-emitter voltage	$T_{vj} = 25^{\circ}\text{C}$	$V_{CES}$	600	V
Kollektor-Dauergleichstrom DC-collector current	$T_C = 65^{\circ}\text{C}$ $T_C = 25^{\circ}\text{C}$	$I_{C,nom.}$ $I_C$	15 19	A A
Periodischer Kollektor Spitzenstrom repetitive peak collector current	$t_p = 1\text{ ms}, T_C = 65^{\circ}\text{C}$	$I_{CRM}$	30	A
Gesamt-Verlustleistung total power dissipation	$T_C = 25^{\circ}\text{C}$	$P_{tot}$	60	W
Gate-Emitter-Spitzenspannung gate-emitter peak voltage		$V_{GES}$	+/- 20V	V

**Diode Wechselrichter/ Diode Inverter**

Dauergleichstrom DC forward current		$I_F$	15	A
Periodischer Spitzenstrom repetitive peak forw. current	$t_p = 1\text{ ms}$	$I_{FRM}$	30	A
Grenzlastintegral $I^2t$ - value	$V_R = 0\text{V}, t_p = 10\text{ms}, T_{vj} = 125^{\circ}\text{C}$	$I^2t$	25	$\text{A}^2\text{s}$

**Transistor Brems-Chopper/ Transistor Brake-Chopper**

Kollektor-Emitter-Sperrspannung collector-emitter voltage	$T_{vj} = 25^{\circ}\text{C}$	$V_{CES}$	600	V
Kollektor-Dauergleichstrom DC-collector current	$T_C = 65^{\circ}\text{C}$ $T_C = 25^{\circ}\text{C}$	$I_{C,nom.}$ $I_C$	15 19	A A
Periodischer Kollektor Spitzenstrom repetitive peak collector current	$t_p = 1\text{ ms}, T_C = 65^{\circ}\text{C}$	$I_{CRM}$	30	A
Gesamt-Verlustleistung total power dissipation	$T_C = 25^{\circ}\text{C}$	$P_{tot}$	60	W
Gate-Emitter-Spitzenspannung gate-emitter peak voltage		$V_{GES}$	+/- 20V	V

**Diode Brems-Chopper/ Diode Brake-Chopper**

Dauergleichstrom DC forward current		$I_F$	15	A
Periodischer Spitzenstrom repetitive peak forw. current	$t_p = 1\text{ ms}$	$I_{FRM}$	30	A

prepared by: Thomas Passe	date of publication: 2002-02-13
approved by: Ingo Graf	revision: 5

# Technische Information / Technical Information

IGBT-Module  
IGBT-Modules

## FP15R06KL4

eupec

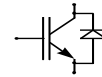

**Vorläufig**  
**Preliminary**

### Modul Isolation/ Module Isolation

Isolations-Prüfspannung insulation test voltage	RMS, f = 50 Hz, t = 1 min. NTC connected to Baseplate	V <sub>ISOL</sub>	2,5	kV
--	--	-------------------	-----	----

## Elektrische Eigenschaften / Electrical properties

### Charakteristische Werte / Characteristic values

#### Diode Gleichrichter/ Diode Rectifier

			min.	typ.	max.	
Durchlaßspannung forward voltage	T <sub>vj</sub> = 150°C, I <sub>F</sub> = 15 A	V <sub>F</sub>	-	1	-	V
Schleusenspannung threshold voltage	T <sub>vj</sub> = 150°C	V <sub>(TO)</sub>	-	0,71	-	V
Ersatzwiderstand slope resistance	T <sub>vj</sub> = 150°C	r <sub>T</sub>	-	18	-	mΩ
Sperrstrom reverse current	T <sub>vj</sub> = 150°C, V <sub>R</sub> = 800 V	I <sub>R</sub>	-	5	-	mA
Modul Leitungswiderstand, Anschlüsse-Chip lead resistance, terminals-chip	T <sub>C</sub> = 25°C	R <sub>AA'+CC'</sub>	-	11	-	mΩ

#### Transistor Wechselrichter/ Transistor Inverter

			min.	typ.	max.	
Kollektor-Emitter Sättigungsspannung collector-emitter saturation voltage	V <sub>GE</sub> = 15V, T <sub>vj</sub> = 25°C, I <sub>C</sub> = 15 A	V <sub>CE sat</sub>	-	1,95	2,55	V
	V <sub>GE</sub> = 15V, T <sub>vj</sub> = 125°C, I <sub>C</sub> = 15 A		-	2,2	-	V
Gate-Schwellenspannung gate threshold voltage	V <sub>CE</sub> = V <sub>GE</sub> , T <sub>vj</sub> = 25°C, I <sub>C</sub> = 0,4mA	V <sub>GE(TO)</sub>	4,5	5,5	6,5	V
Eingangskapazität input capacitance	f = 1MHz, T <sub>vj</sub> = 25°C V <sub>CE</sub> = 25 V, V <sub>GE</sub> = 0 V	C <sub>ies</sub>	-	0,8	-	nF
Kollektor-Emitter Reststrom collector-emitter cut-off current	V <sub>GE</sub> = 0V, T <sub>vj</sub> = 125°C, V <sub>CE</sub> = 600V	I <sub>CES</sub>	-	5,0	-	mA
Gate-Emitter Reststrom gate-emitter leakage current	V <sub>CE</sub> = 0V, V <sub>GE</sub> = 20V, T <sub>vj</sub> = 25°C	I <sub>GES</sub>	-	-	400	nA
Einschaltverzögerungszeit (ind. Last) turn on delay time (inductive load)	I <sub>C</sub> = I <sub>Nenn</sub> , V <sub>CC</sub> = 300 V V <sub>GE</sub> = ±15V, T <sub>vj</sub> = 25°C, R <sub>G</sub> = 68 Ohm	t <sub>d,on</sub>	-	37	-	ns
	V <sub>GE</sub> = ±15V, T <sub>vj</sub> = 125°C, R <sub>G</sub> = 68 Ohm		-	34	-	ns
Anstiegszeit (induktive Last) rise time (inductive load)	I <sub>C</sub> = I <sub>Nenn</sub> , V <sub>CC</sub> = 300 V V <sub>GE</sub> = ±15V, T <sub>vj</sub> = 25°C, R <sub>G</sub> = 68 Ohm	t <sub>r</sub>	-	37	-	ns
	V <sub>GE</sub> = ±15V, T <sub>vj</sub> = 125°C, R <sub>G</sub> = 68 Ohm		-	37	-	ns
Abschaltverzögerungszeit (ind. Last) turn off delay time (inductive load)	I <sub>C</sub> = I <sub>Nenn</sub> , V <sub>CC</sub> = 300 V V <sub>GE</sub> = ±15V, T <sub>vj</sub> = 25°C, R <sub>G</sub> = 68 Ohm	t <sub>d,off</sub>	-	216	-	ns
	V <sub>GE</sub> = ±15V, T <sub>vj</sub> = 125°C, R <sub>G</sub> = 68 Ohm		-	223	-	ns
Fallzeit (induktive Last) fall time (inductive load)	I <sub>C</sub> = I <sub>Nenn</sub> , V <sub>CC</sub> = 300 V V <sub>GE</sub> = ±15V, T <sub>vj</sub> = 25°C, R <sub>G</sub> = 68 Ohm	t <sub>f</sub>	-	17	-	ns
	V <sub>GE</sub> = ±15V, T <sub>vj</sub> = 125°C, R <sub>G</sub> = 68 Ohm		-	26	-	ns
Einschaltverlustenergie pro Puls turn-on energy loss per pulse	I <sub>C</sub> = I <sub>Nenn</sub> , V <sub>CC</sub> = 300 V V <sub>GE</sub> = ±15V, T <sub>vj</sub> = 125°C, R <sub>G</sub> = 68 Ohm L <sub>S</sub> = 80 nH	E <sub>on</sub>	-	0,6	-	mWs
Abschaltverlustenergie pro Puls turn-off energy loss per pulse	I <sub>C</sub> = I <sub>Nenn</sub> , V <sub>CC</sub> = 300 V V <sub>GE</sub> = ±15V, T <sub>vj</sub> = 125°C, R <sub>G</sub> = 68 Ohm L <sub>S</sub> = 80 nH	E <sub>off</sub>	-	0,4	-	mWs
Kurzschlußverhalten SC Data	t <sub>p</sub> ≤ 10µs, V <sub>GE</sub> ≤ 15V, R <sub>G</sub> = 68 Ohm T <sub>vj</sub> ≤ 125°C, V <sub>CC</sub> = 360 V di/dt = 1000 A/µs	I <sub>SC</sub>	-	60	-	A

# Technische Information / Technical Information

IGBT-Module  
IGBT-Modules

## FP15R06KL4

eupec

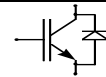

**Vorläufig**  
**Preliminary**

### Elektrische Eigenschaften / Electrical properties

#### Charakteristische Werte / Characteristic values

		min.	typ.	max.		
Modulinduktivität stray inductance module		$L_{\text{gCE}}$	-	-	40	nH
Modul Leitungswiderstand, Anschlüsse-Chip lead resistance, terminals-chip	$T_C = 25^\circ\text{C}$	$R_{\text{CC}'+\text{EE}'}$	-	14	-	m $\Omega$
<b>Diode Wechselrichter/ Diode Inverter</b>			<b>min.</b>	<b>typ.</b>	<b>max.</b>	
Durchlaßspannung forward voltage	$V_{\text{GE}} = 0\text{V}, T_{\text{vj}} = 25^\circ\text{C}, I_{\text{F}} = 15\text{A}$ $V_{\text{GE}} = 0\text{V}, T_{\text{vj}} = 125^\circ\text{C}, I_{\text{F}} = 15\text{A}$	$V_{\text{F}}$	-	1,75 1,8	2,15 -	V V
Rückstromspitze peak reverse recovery current	$I_{\text{F}}=I_{\text{Nenn}}, -di_{\text{F}}/dt = 600\text{A/us}$ $V_{\text{GE}} = -10\text{V}, T_{\text{vj}} = 25^\circ\text{C}, V_{\text{R}} = 300\text{V}$ $V_{\text{GE}} = -10\text{V}, T_{\text{vj}} = 125^\circ\text{C}, V_{\text{R}} = 300\text{V}$	$I_{\text{RM}}$	-	13 14	- -	A A
Sperrverzögerungsladung recovered charge	$I_{\text{F}}=I_{\text{Nenn}}, -di_{\text{F}}/dt = 600\text{A/us}$ $V_{\text{GE}} = -10\text{V}, T_{\text{vj}} = 25^\circ\text{C}, V_{\text{R}} = 300\text{V}$ $V_{\text{GE}} = -10\text{V}, T_{\text{vj}} = 125^\circ\text{C}, V_{\text{R}} = 300\text{V}$	$Q_{\text{r}}$	-	0,8 1,4	- -	$\mu\text{As}$ $\mu\text{As}$
Abschaltenergie pro Puls reverse recovery energy	$I_{\text{F}}=I_{\text{Nenn}}, -di_{\text{F}}/dt = 600\text{A/us}$ $V_{\text{GE}} = -10\text{V}, T_{\text{vj}} = 25^\circ\text{C}, V_{\text{R}} = 300\text{V}$ $V_{\text{GE}} = -10\text{V}, T_{\text{vj}} = 125^\circ\text{C}, V_{\text{R}} = 300\text{V}$	$E_{\text{rec}}$	-	0,14 0,24	- -	mWs mWs
<b>Transistor Brems-Chopper/ Transistor Brake-Chopper</b>			<b>min.</b>	<b>typ.</b>	<b>max.</b>	
Kollektor-Emitter Sättigungsspannung collector-emitter saturation voltage	$V_{\text{GE}} = 15\text{V}, T_{\text{vj}} = 25^\circ\text{C}, I_{\text{C}} = 15,0\text{A}$ $V_{\text{GE}} = 15\text{V}, T_{\text{vj}} = 125^\circ\text{C}, I_{\text{C}} = 15,0\text{A}$	$V_{\text{CE sat}}$	-	1,95 2,2	2,55 -	V V
Gate-Schwellenspannung gate threshold voltage	$V_{\text{CE}} = V_{\text{GE}}, T_{\text{vj}} = 25^\circ\text{C}, I_{\text{C}} = 0,4\text{mA}$	$V_{\text{GE(To)}}$	4,5	5,5	6,5	V
Eingangskapazität input capacitance	$f = 1\text{MHz}, T_{\text{vj}} = 25^\circ\text{C}$ $V_{\text{CE}} = 25\text{V}, V_{\text{GE}} = 0\text{V}$	$C_{\text{ies}}$	-	0,8	-	nF
Kollektor-Emitter Reststrom collector-emitter cut-off current	$V_{\text{GE}} = 0\text{V}, T_{\text{vj}} = 125^\circ\text{C}, V_{\text{CE}} = 600\text{V}$		-	5,0	-	mA
Gate-Emitter Reststrom gate-emitter leakage current	$V_{\text{CE}} = 0\text{V}, V_{\text{GE}} = 20\text{V}, T_{\text{vj}} = 25^\circ\text{C}$	$I_{\text{GES}}$	-	-	400	nA
<b>Diode Brems-Chopper/ Diode Brake-Chopper</b>			<b>min.</b>	<b>typ.</b>	<b>max.</b>	
Durchlaßspannung forward voltage	$T_{\text{vj}} = 25^\circ\text{C}, I_{\text{F}} = 15\text{A}$ $T_{\text{vj}} = 125^\circ\text{C}, I_{\text{F}} = 15\text{A}$	$V_{\text{F}}$	-	2,15 2,25	2,6 -	V V
<b>NTC-Widerstand/ NTC-Thermistor</b>			<b>min.</b>	<b>typ.</b>	<b>max.</b>	
Nennwiderstand rated resistance	$T_C = 25^\circ\text{C}$	$R_{25}$	-	5	-	k $\Omega$
Abweichung von $R_{100}$ deviation of $R_{100}$	$T_C = 100^\circ\text{C}, R_{100} = 493\ \Omega$	$\Delta R/R$	-5		5	%
Verlustleistung power dissipation	$T_C = 25^\circ\text{C}$	$P_{25}$			20	mW
B-Wert B-value	$R_2 = R_1 \exp [B(1/T_2 - 1/T_1)]$	$B_{25/50}$		3375		K

# Technische Information / Technical Information

IGBT-Module  
IGBT-Modules

## FP15R06KL4

eupec

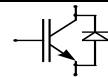

**Vorläufig  
Preliminary**

### Thermische Eigenschaften / Thermal properties

				min.	typ.	max.	
Innerer Wärmewiderstand thermal resistance, junction to heatsink	Gleichr. Diode/ Rectif. Diode	$\lambda_{\text{Paste}}=1\text{W/m}^2\text{K}$	$R_{\text{thJH}}$	-	2,6	-	K/W
	Trans. Wechr./ Trans. Inverter	$\lambda_{\text{grease}}=1\text{W/m}^2\text{K}$		-	2,4	-	K/W
	Diode Wechr./ Diode Inverter			-	4,0	-	K/W
	Trans. Bremse/ Trans. Brake			-	2,4	-	K/W
	Diode Bremse/ Diode Brake			-	4,3	-	K/W
Innerer Wärmewiderstand thermal resistance, junction to case	Gleichr. Diode/ Rectif. Diode		$R_{\text{thJC}}$	-	-	2,4	K/W
	Trans. Wechr./ Trans. Inverter			-	-	2	K/W
	Diode Wechr./ Diode Inverter			-	-	2,9	K/W
	Trans. Bremse/ Trans. Brake			-	-	2	K/W
	Diode Bremse/ Diode Brake			-	-	3,1	K/W
Übergangs-Wärmewiderstand thermal resistance, case to heatsink	Gleichr. Diode/ Rectif. Diode	$\lambda_{\text{Paste}}=1\text{W/m}^2\text{K}$	$R_{\text{thCH}}$	-	0,4	-	K/W
	Trans. Wechr./ Trans. Inverter	$\lambda_{\text{grease}}=1\text{W/m}^2\text{K}$		-	0,6	-	K/W
	Diode Wechr./ Diode Inverter			-	1,4	-	K/W
	Trans. Bremse/ Trans. Brake			-	0,6	-	K/W
	Diode Bremse/ Diode Brake			-	1,5	-	K/W
Höchstzulässige Sperrschichttemperatur maximum junction temperature			$T_{\text{vj}}$	-	-	150	°C
Betriebstemperatur operation temperature			$T_{\text{op}}$	-40	-	125	°C
Lagertemperatur storage temperature			$T_{\text{stg}}$	-40	-	125	°C

### Mechanische Eigenschaften / Mechanical properties

Innere Isolation internal insulation				$\text{Al}_2\text{O}_3$	
CTI comperative tracking index				225	
Anpreßkraft f. mech. Befestigung pro Feder mounting force per clamp		F		40...80	N
Gewicht weight		G		36	g
Kontakt - Kühlkörper terminal to heatsink	Kriechstrecke creeping distance			13,5	mm
	Luftstrecke clearance			12	mm
Terminal - Terminal terminal to terminal	Kriechstrecke creeping distance			7,5	mm
	Luftstrecke clearance			7,5	mm

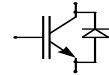

Vorläufig  
Preliminary

**Ausgangskennlinienfeld Wechselr. (typisch)**  $I_C = f(V_{CE})$   
**Output characteristic Inverter (typical)**  $V_{GE} = 15\text{ V}$

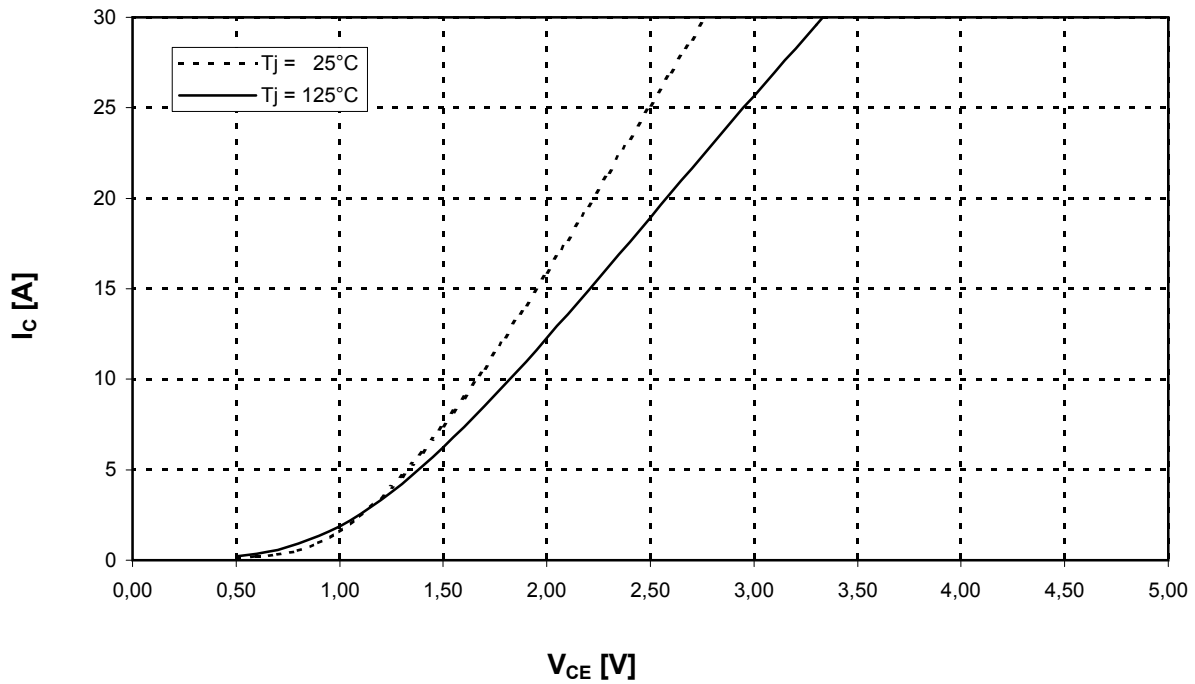

**Ausgangskennlinienfeld Wechselr. (typisch)**  $I_C = f(V_{CE})$   
**Output characteristic Inverter (typical)**  $T_{vj} = 125^\circ\text{C}$

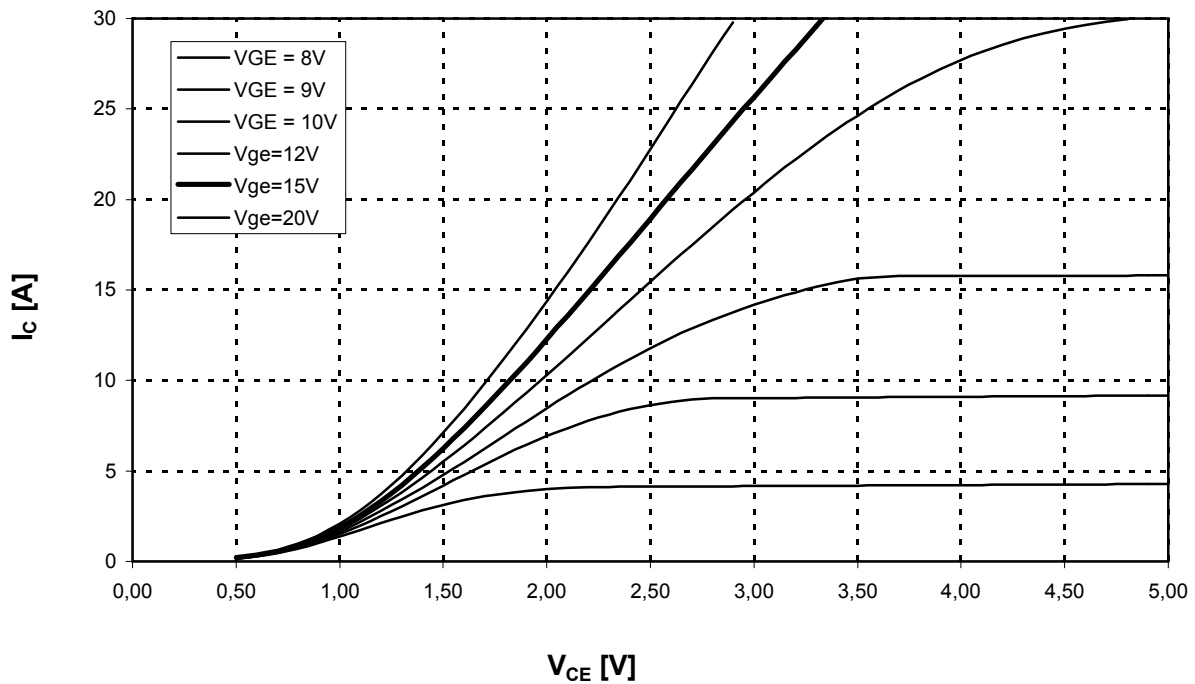

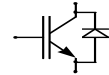

Vorläufig  
Preliminary

Übertragungscharakteristik Wechselr. (typisch)

$I_C = f(V_{GE})$

Transfer characteristic Inverter (typical)

$V_{CE} = 20\text{ V}$

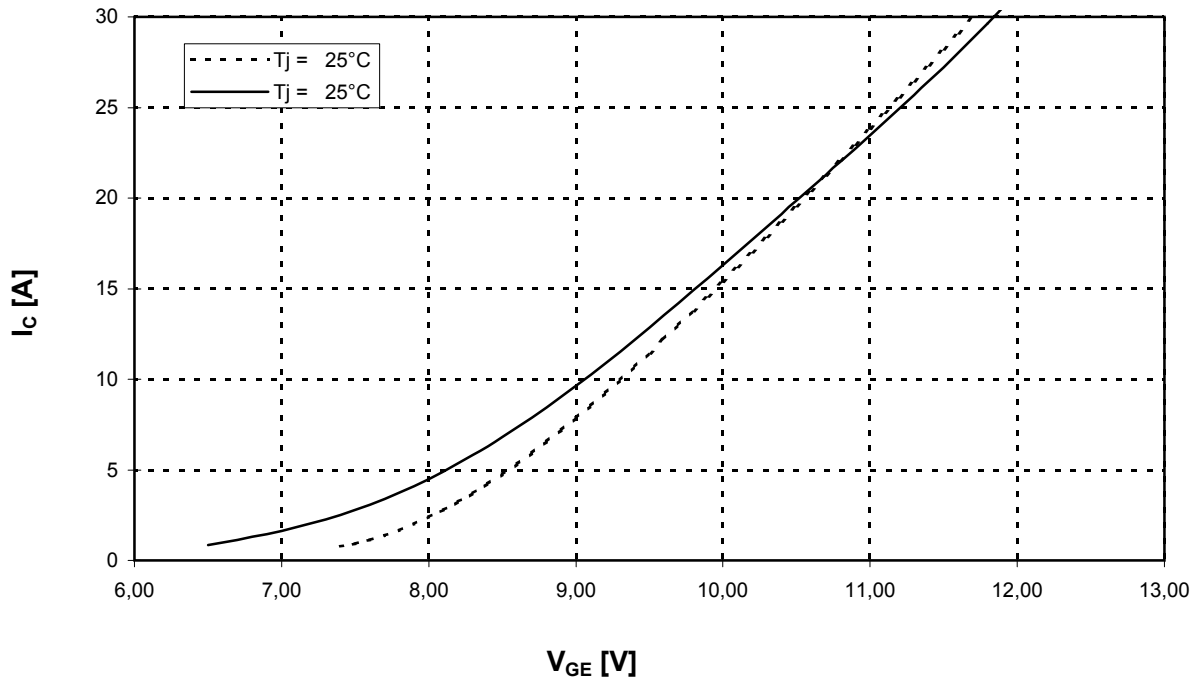

Durchlaßkennlinie der Freilaufdiode Wechselr. (typisch)

$I_F = f(V_F)$

Forward characteristic of FWD Inverter (typical)

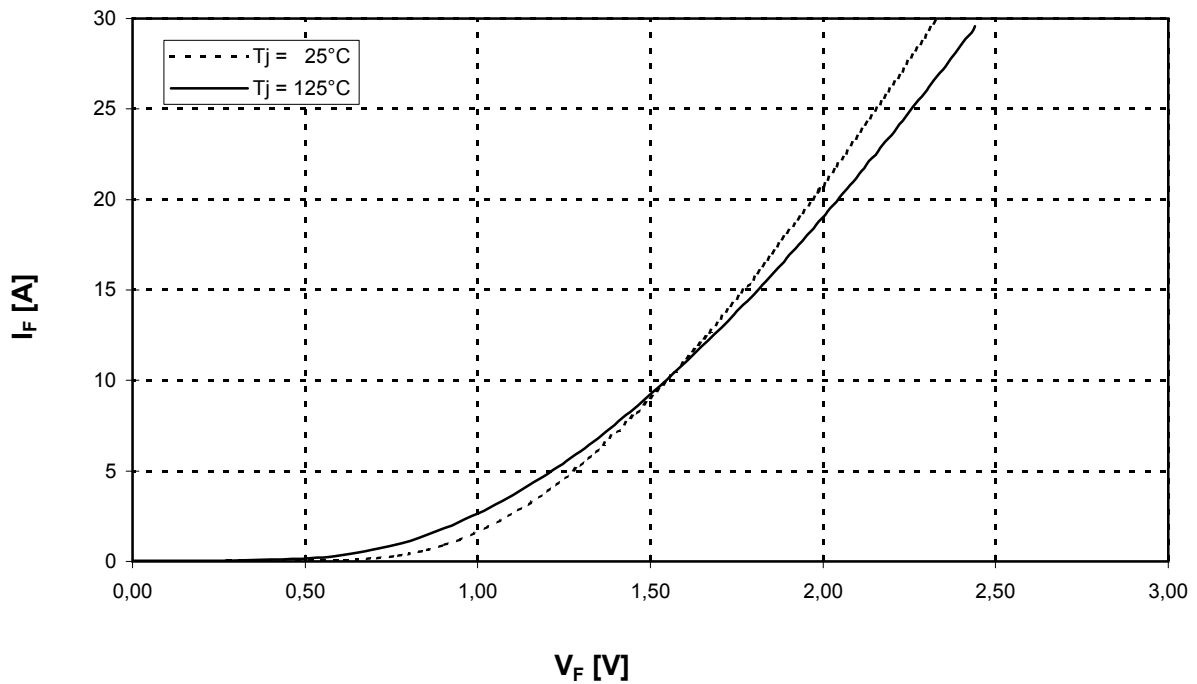

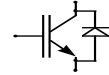

Vorläufig  
Preliminary

Schaltverluste Wechselr. (typisch)  $E_{on} = f(I_c), E_{off} = f(I_c), E_{rec} = f(I_c)$   $V_{CC} = 300\text{ V}$   
 Switching losses Inverter (typical)  $T_j = 125^\circ\text{C}, V_{GE} = \pm 15\text{ V}, R_{Gon} = R_{Goff} = 68\text{ Ohm}$

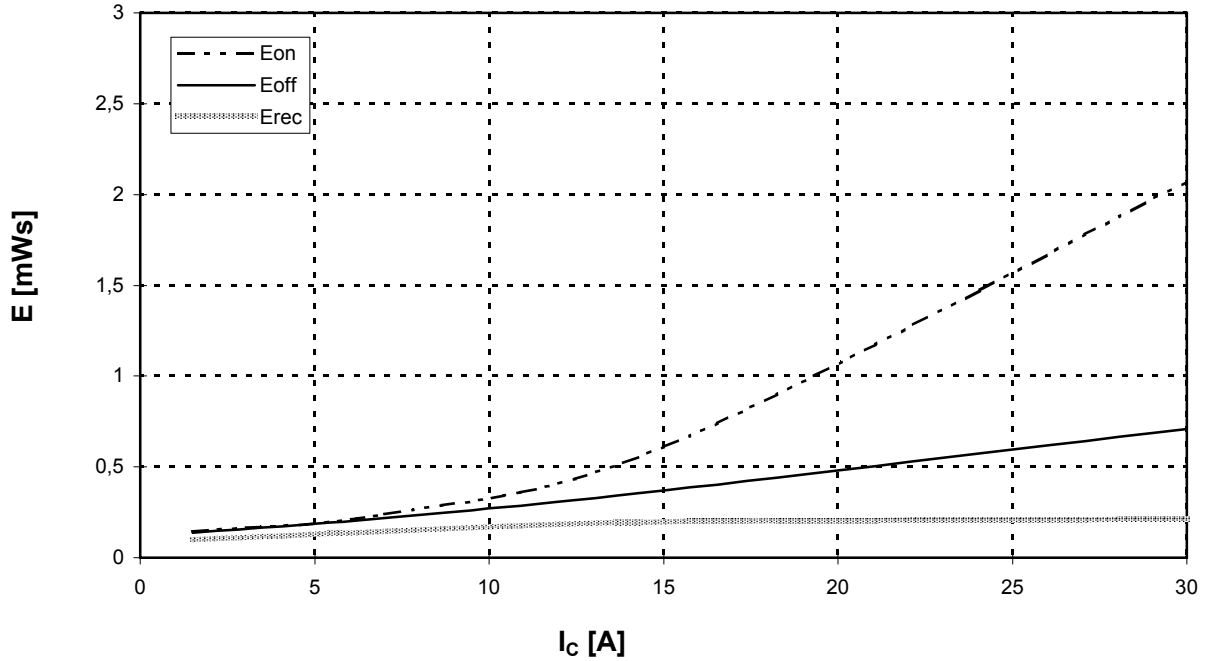

Schaltverluste Wechselr. (typisch)  $E_{on} = f(R_G), E_{off} = f(R_G), E_{rec} = f(R_G)$   
 Switching losses Inverter (typical)  $T_j = 125^\circ\text{C}, V_{GE} = +15\text{ V}, I_c = I_{nenn}, V_{CC} = 300\text{ V}$

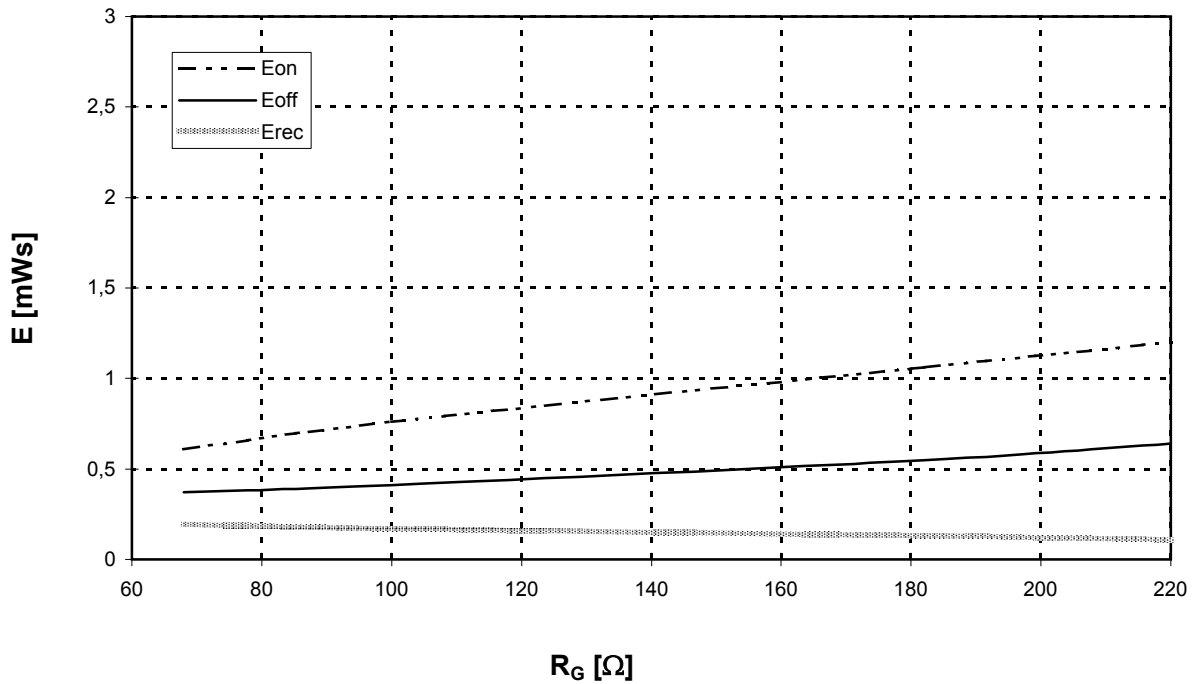

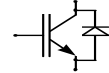

Vorläufig  
Preliminary

Transienter Wärmewiderstand Wechsler.  $Z_{thJH} = f(t)$   
Transient thermal impedance Inverter

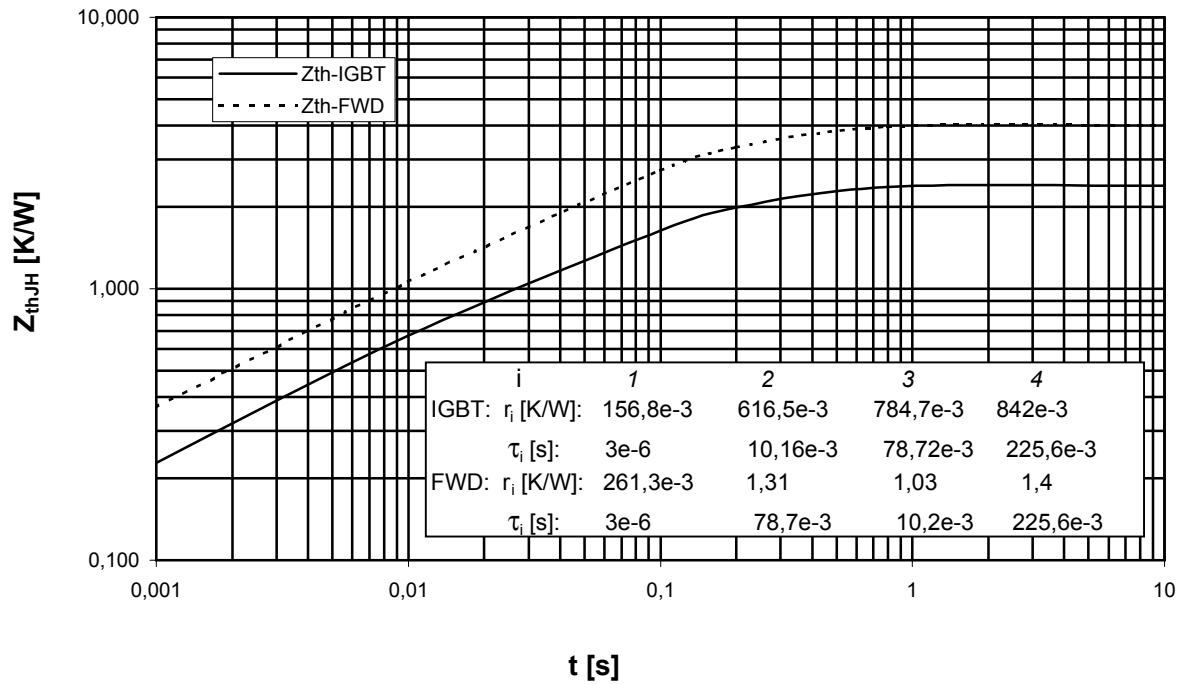

Sicherer Arbeitsbereich Wechsler. (RBSOA)  $I_C = f(V_{CE})$   
Reverse bias safe operating area Inverter (RBSOA)  $T_{vj} = 125^\circ\text{C}$ ,  $V_{GE} = \pm 15\text{V}$ ,  $R_G = 68 \text{ Ohm}$

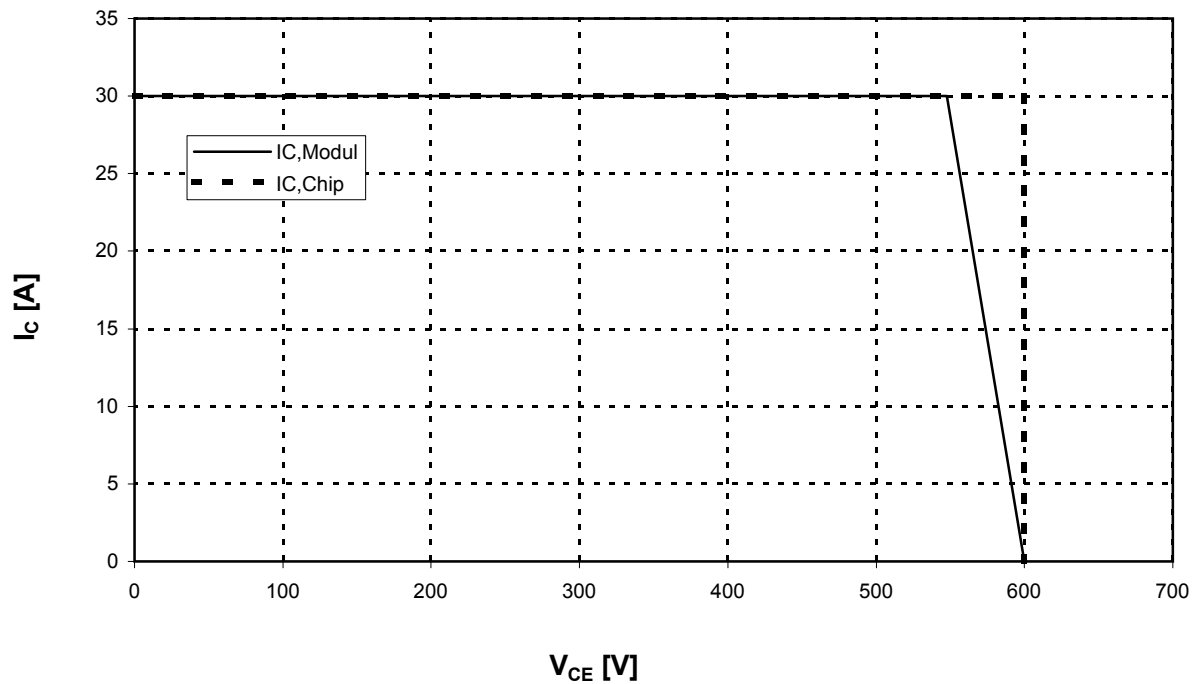



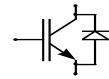

Vorläufig  
Preliminary

Ausgangskennlinienfeld Brems-Chopper-IGBT (typisch)  $I_C = f(V_{CE})$

Output characteristic brake-chopper-IGBT (typical)

$I_C = f(V_{CE})$

$V_{GE} = 15\text{ V}$

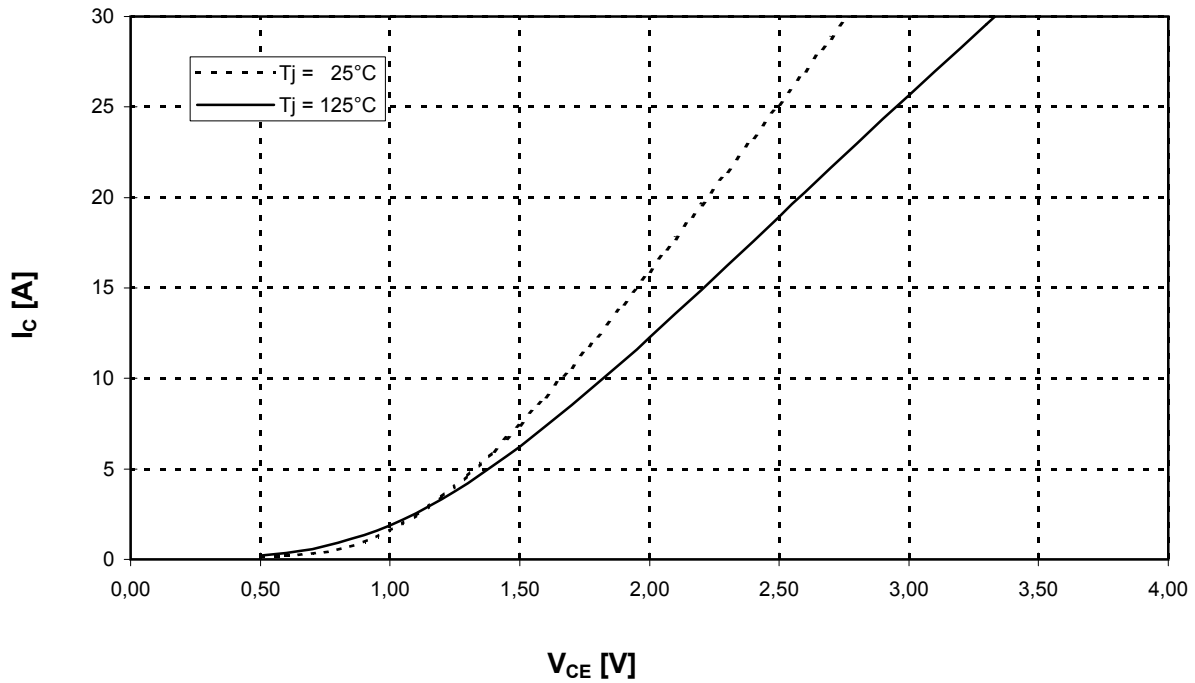

Durchlaßkennlinie der Brems-Chopper-Diode (typisch)  $I_F = f(V_F)$

Forward characteristic of brake-chopper-FWD (typical)

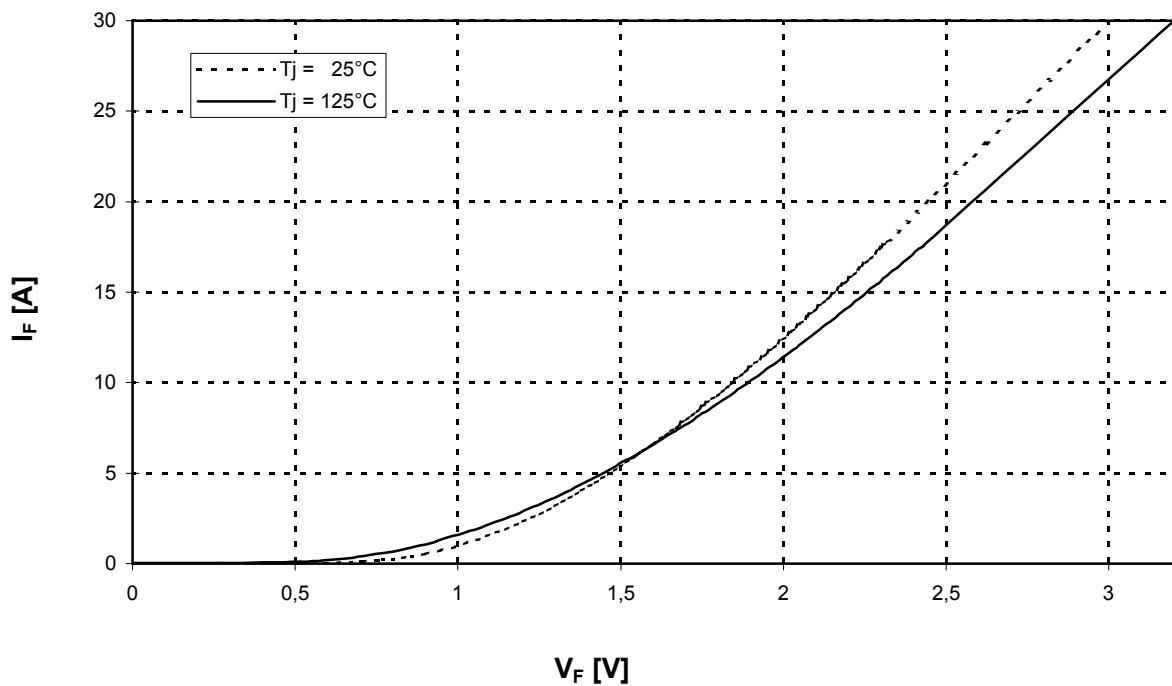

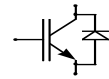

Vorläufig  
Preliminary

Durchlaßkennlinie der Gleichrichterdiode (typisch)  $I_F = f(V_F)$   
Forward characteristic of Rectifier Diode (typical)

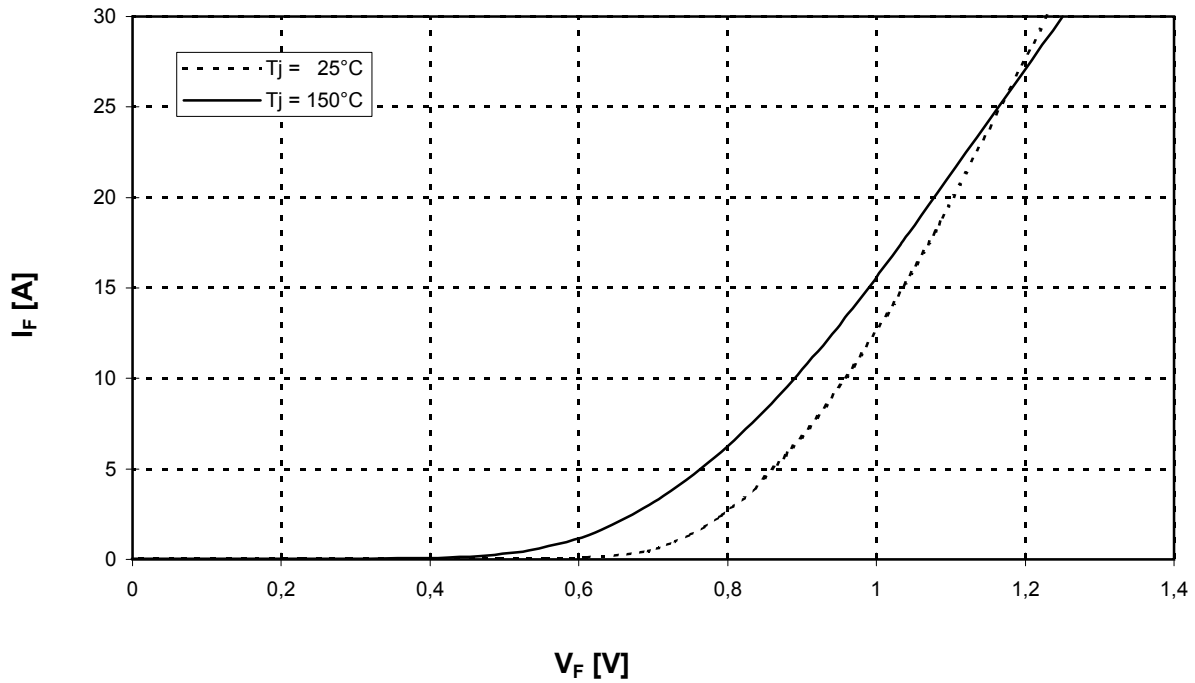

NTC- Temperaturkennlinie (typisch)  $R = f(T)$   
NTC- temperature characteristic (typical)

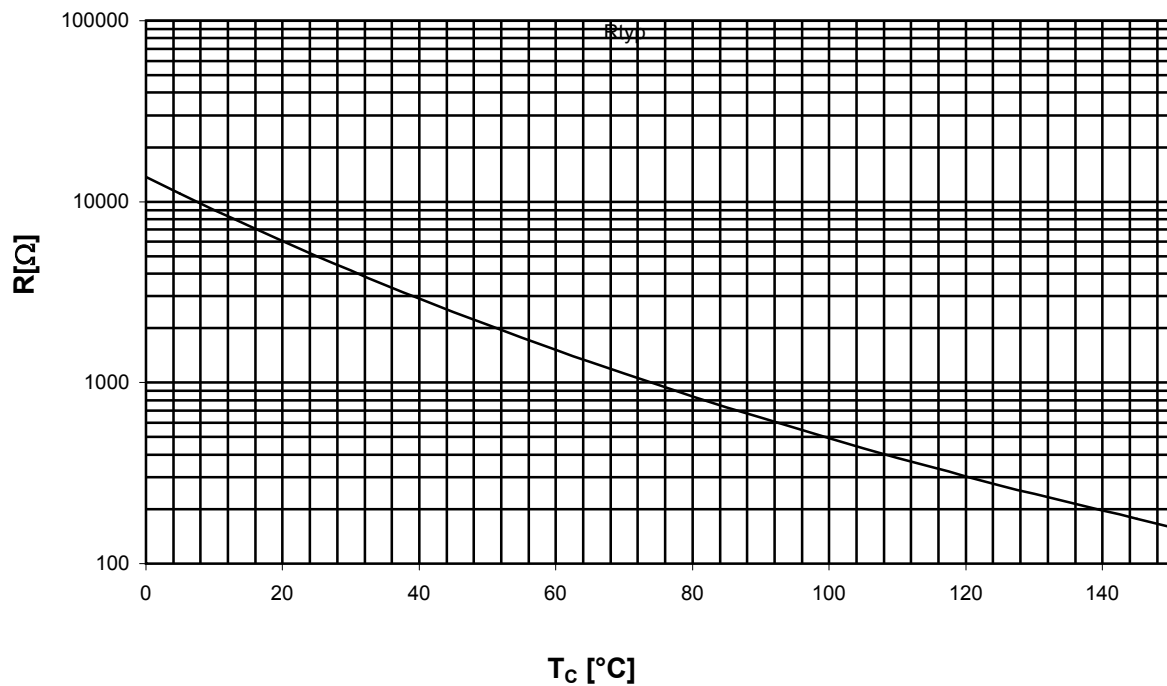

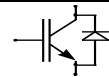

Vorläufig  
Preliminary

Schaltplan/ Circuit diagram

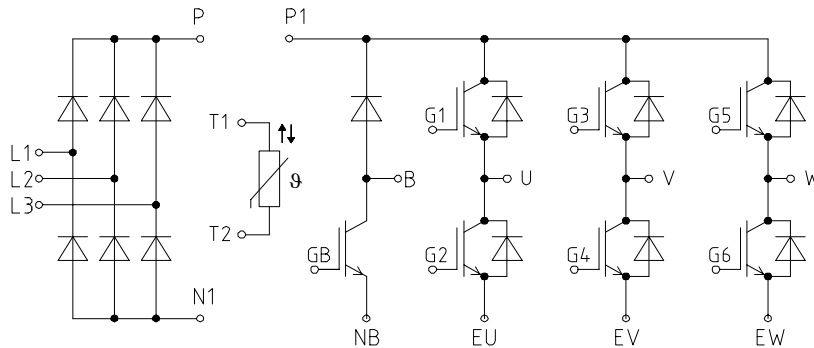

Gehäuseabmessungen/ Package outlines

Modul only designed for mounting on PCB's with 1.6 ±0.2 mm thickness

Pinpositions with tolerance  $\boxed{\oplus \varnothing 0.4}$

Bohrplan /  
drilling layout

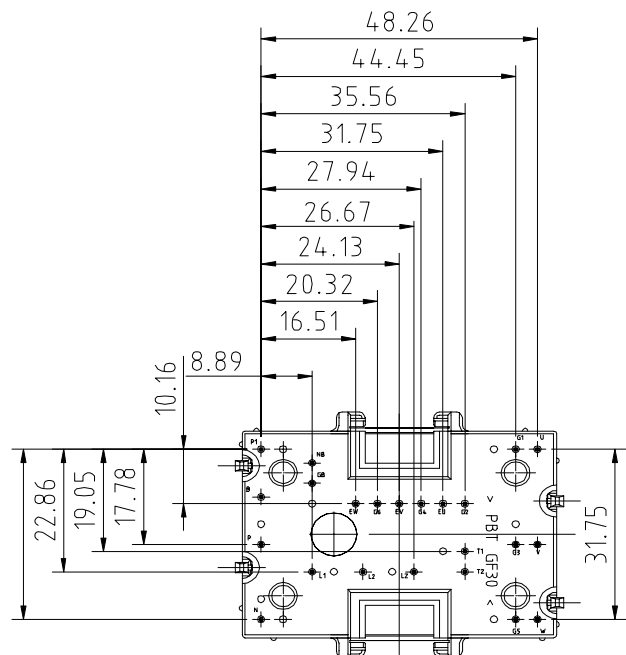
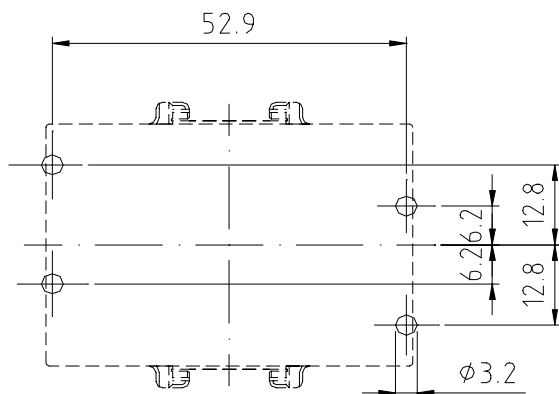

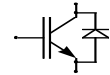

Gehäuseabmessungen Forts. / Package outlines contd.

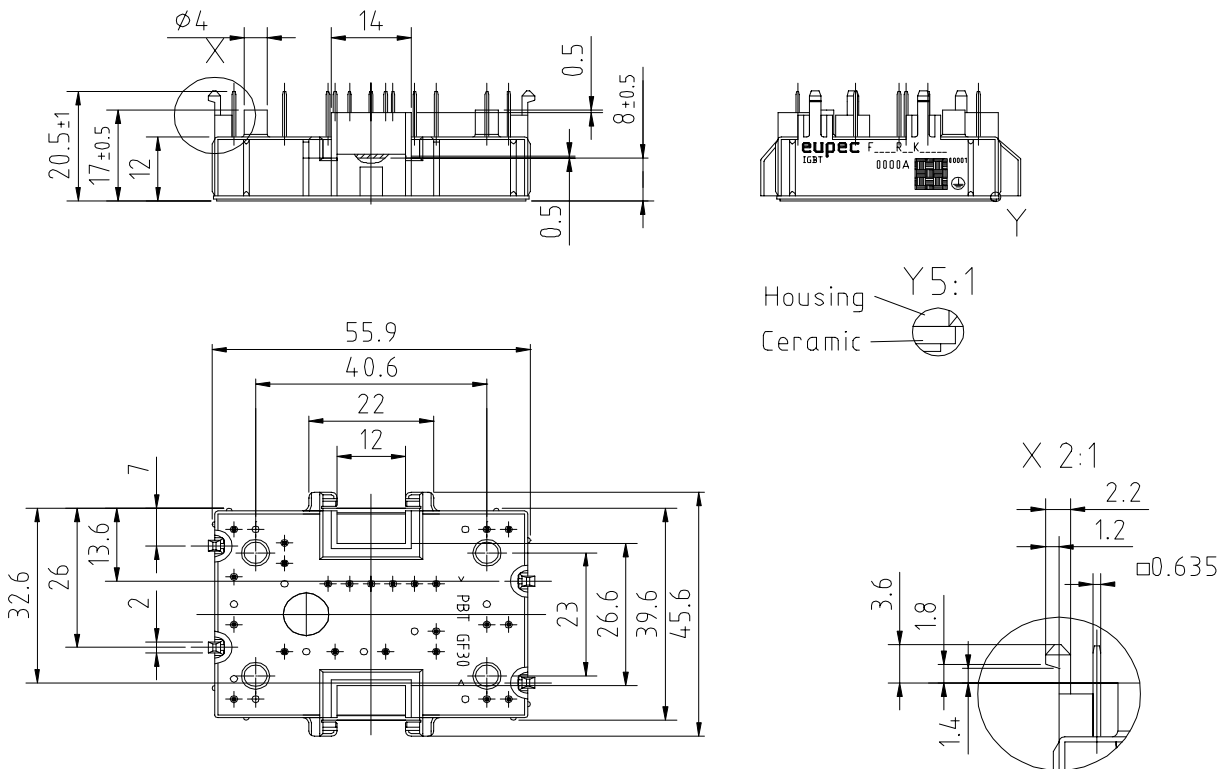

Mit dieser technischen Information werden Halbleiterbauelemente spezifiziert, jedoch keine Eigenschaften zugesichert. Diese gilt in Verbindung mit den zugehörigen Technischen Erläuterungen.

This technical information specifies semiconductor devices but promises no characteristics. It is valid in combination with the belonging technical note: