



FP204

PNP/NPN Epitaxial Planar Silicon Transistors

Push-Pull Circuit Applications

Features

- Composite type with a PNP transistor and an NPN transistor in one package, facilitating high-density mounting.
- The FP204 is composed of 2 chips, one being equivalent to the 2SB1123 and 2SD1623, which are placed in one package.

Electrical Connection

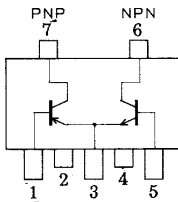

- 1:Base
2:Collector
3:Emitter Common
4:Collector
5:Base
6:Collector
7:Collector
(Top view)

Specifications

Absolute Maximum Ratings at Ta = 25°C

Parameter	Symbol	Conditions	Ratings	Unit
Collector-to-Base Voltage	V_{CBO}		(-)60	V
Collector-to-Emitter Voltage	V_{CEO}		(-)50	V
Emitter-to-Base Voltage	V_{EBO}		(-)6	V
Collector Current	I_C		(-)2	A
Collector Current (Pulse)	I_{CP}		(-)4	A
Base Current	I_B		(-)0.4	A
Collector Dissipation	P_C	Mounted on ceramic board (250mm ² ×0.8mm) 1unit	0.8	W
Total Power Dissipation	P_T	Mounted on ceramic board (250mm ² ×0.8mm)	1.1	W
Junction Temperature	T_j		150	°C
Storage Temperature	T_{stg}		-55 to +150	°C

() : PNP

Electrical Characteristics at Ta=25°C

Parameter	Symbol	Conditions	Ratings			Unit
			min	typ	max	
Collector Cutoff Current	I_{CBO}	$V_{CB}=(-)50V, I_E=0$			(-)100	nA
Emitter Cutoff Current	I_{EBO}	$V_{EB}=(-)4V, I_C=0$			(-)100	nA
DC Current Gain	h_{FE}	$V_{CE}=(-)2V, I_C=(-)100mA$	140		400	
Gain-Bandwidth Product	f_T	$V_{CE}=(-)10V, I_C=(-)50mA$		150		MHz
Output Capacitance	C_{ob}	$V_{CB}=(-)10V, f=1MHz$		(22)		pF
				12		pF
C-E Saturation Voltage	$V_{CE(sat)}$	$I_C=(-)1.0A, I_B=(-)50mA$		(-250)	(-500)	mV
				150	300	mV
B-E Saturation Voltage	$V_{BE(sat)}$	$I_C=(-)1.0A, I_B=(-)50mA$		(-)0.9	(-)1.2	V
C-B Breakdown Voltage	$V_{(BR)CBO}$	$I_C=(-)10\mu A, I_E=0$	(-)60			V
C-E Breakdown Voltage	$V_{(BR)CEO}$	$I_C=(-)1mA, R_{BE}=\infty$	(-)50			V
E-B Breakdown Voltage	$V_{(BR)EBO}$	$I_E=(-)10\mu A, I_C=0$	(-)6			V
Turn-ON Time	t_{on}	See specified Test Circuit		60		ns
Storage Time	t_{stg}	See specified Test Circuit		(450)		ns
				550		ns
Fall Time	t_f	See specified Test Circuit		30		ns

Marking:204

SANYO Electric Co.,Ltd. Semiconductor Business Headquarters

TOKYO OFFICE Tokyo Bldg., 1-10, 1 Chome, Ueno, Taito-ku, TOKYO, 110-8534 JAPAN

Package Dimensions

unit:mm

2097A

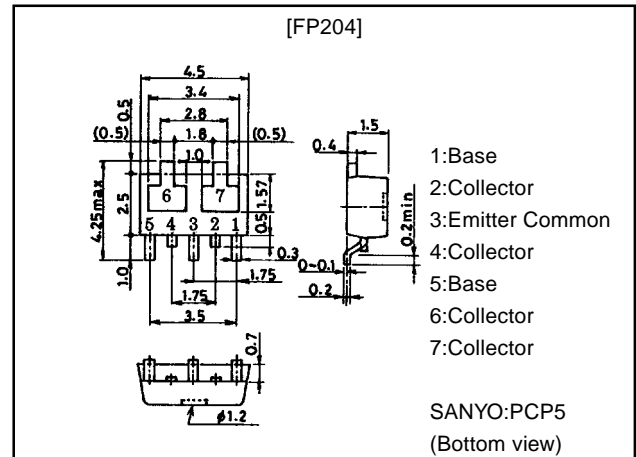

Switching Time Test Circuit

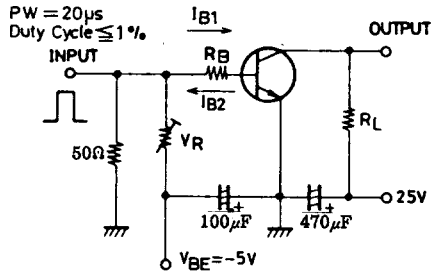

$I_C = 10I_{B1} = -10I_{B2} = 500\text{mA}$, $V_{CC} = 25\text{V}$
 For PNP, the polarity is reversed.

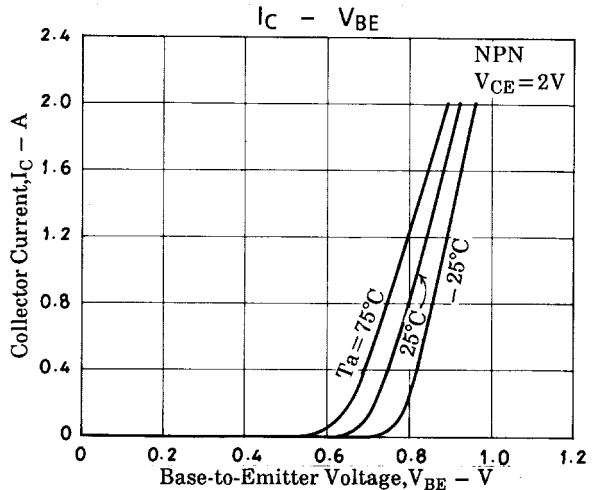
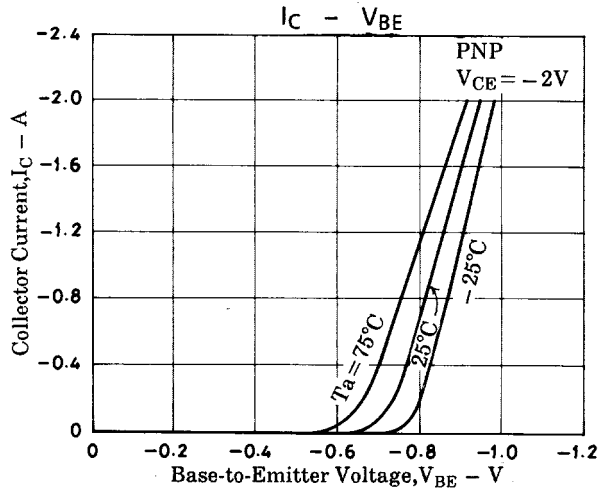
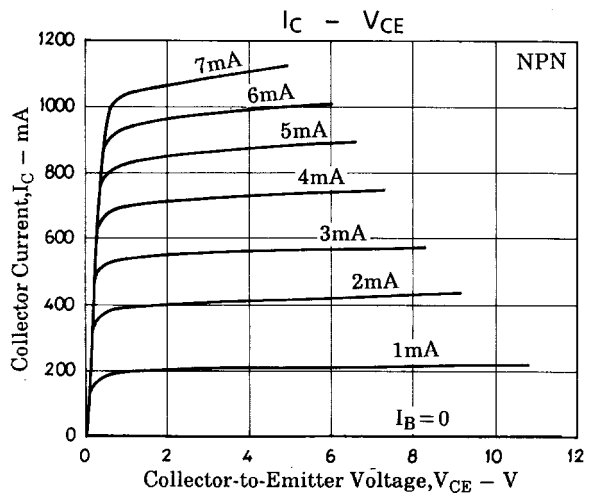
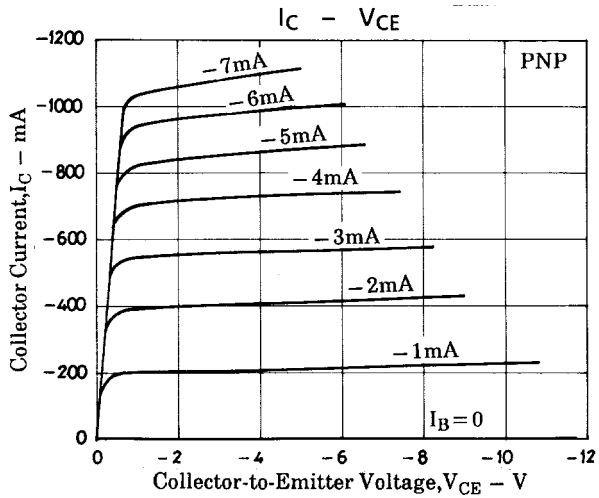
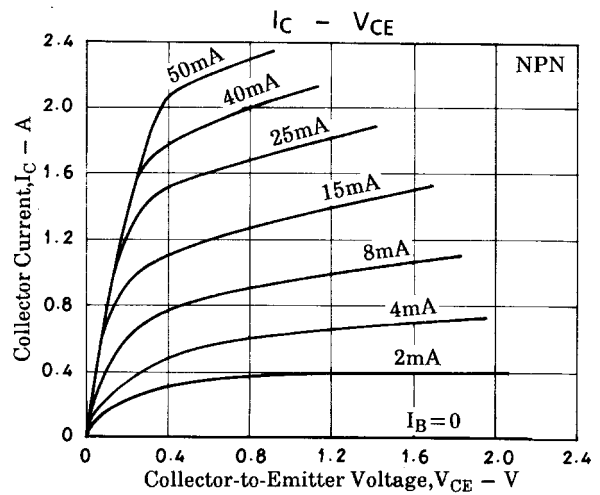
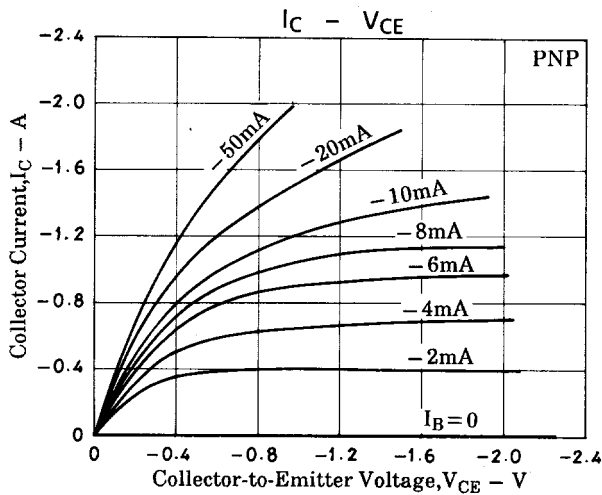

FP204

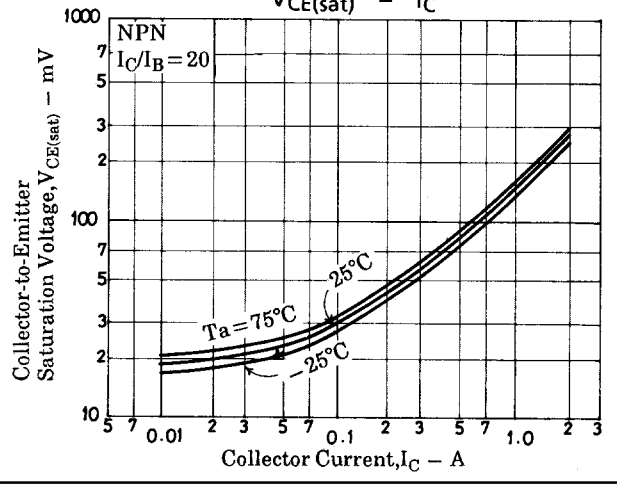
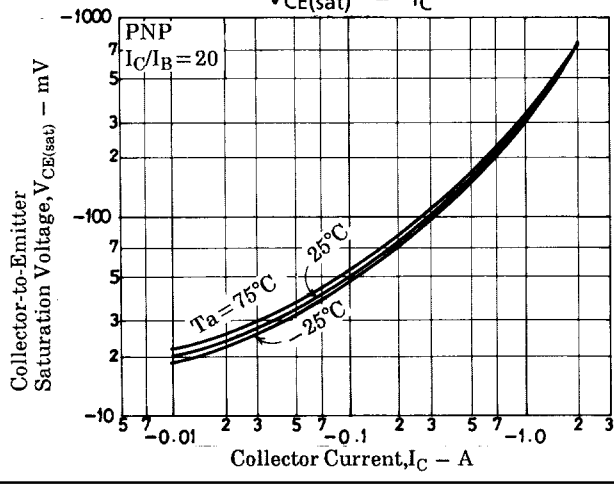
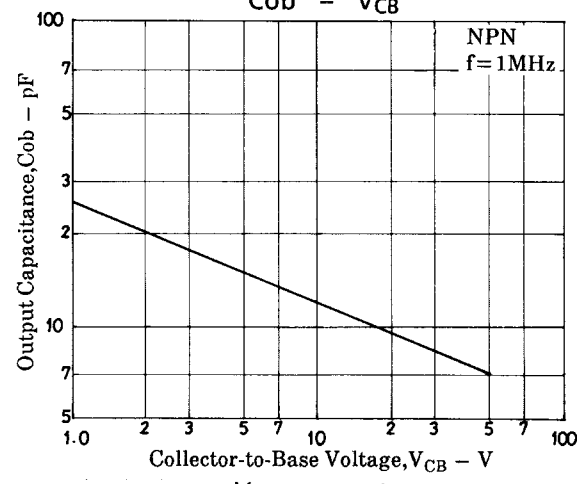
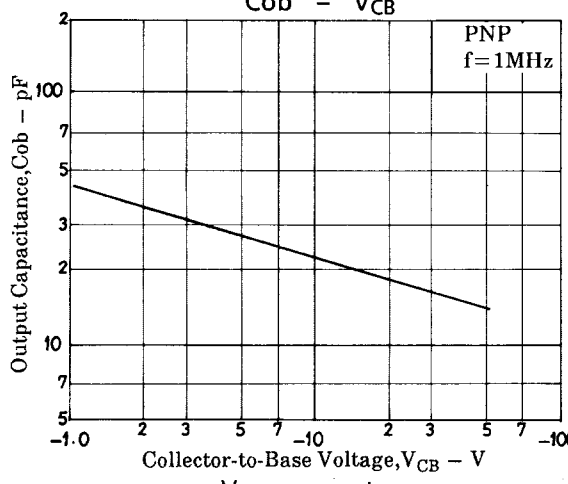
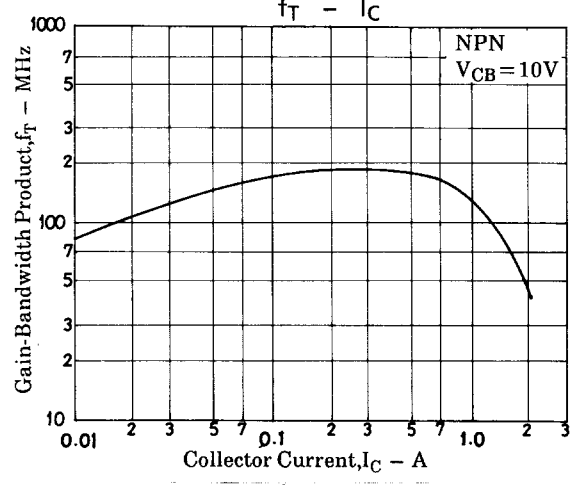
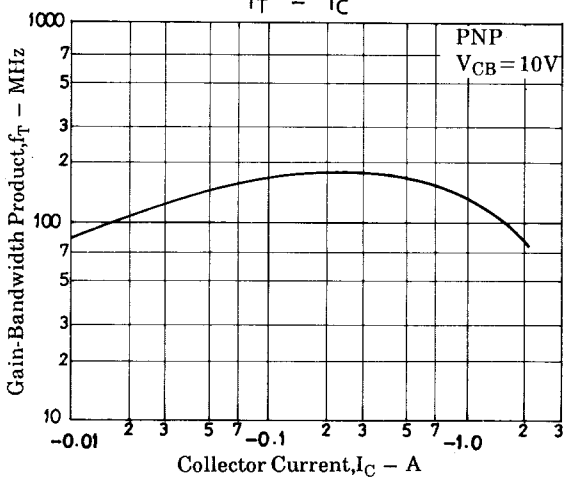
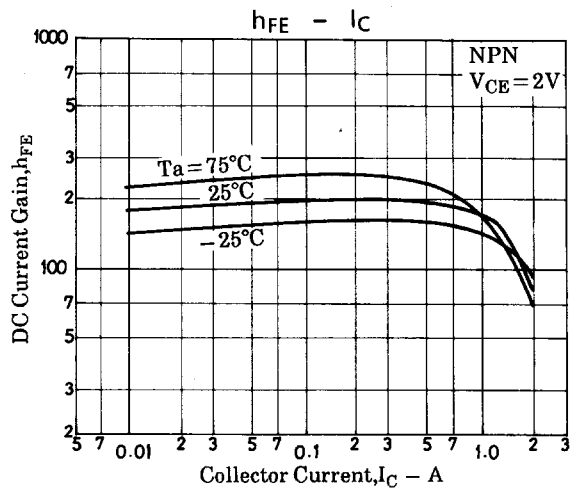
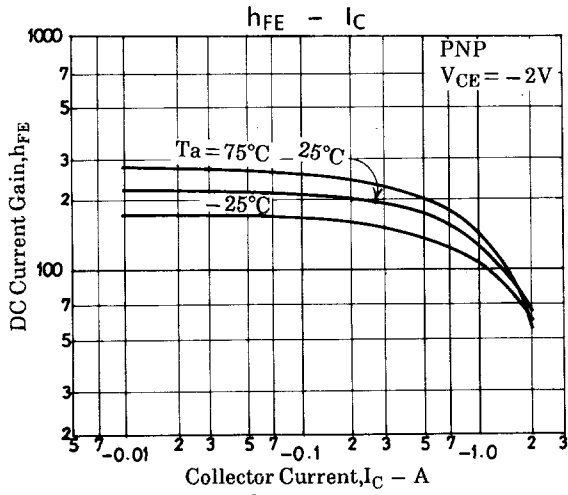

FP204

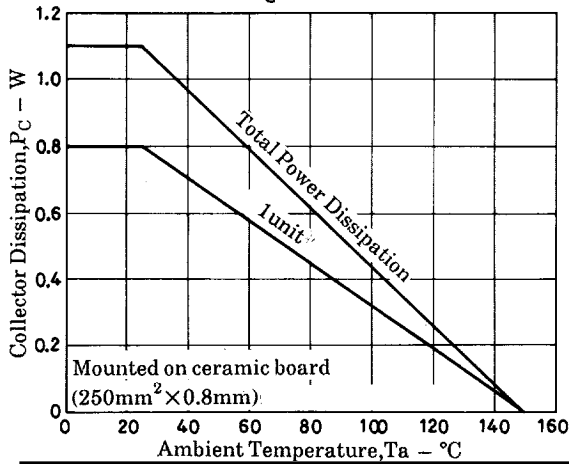
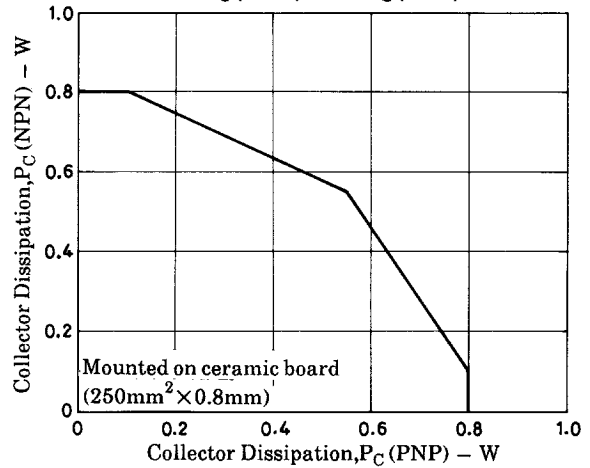
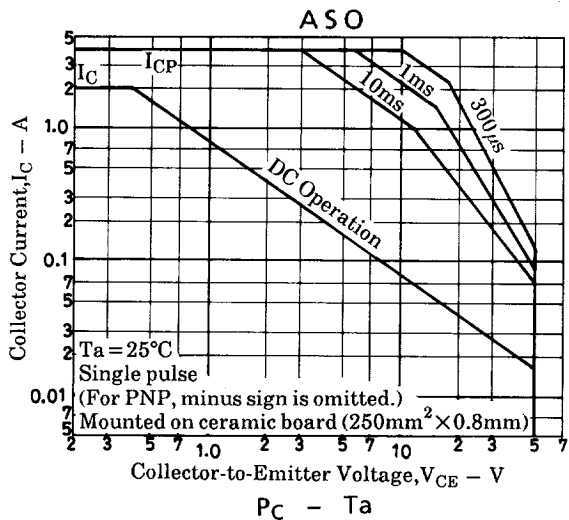
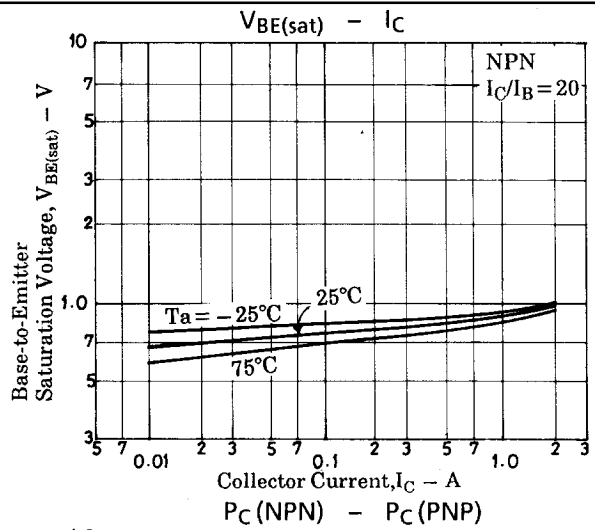
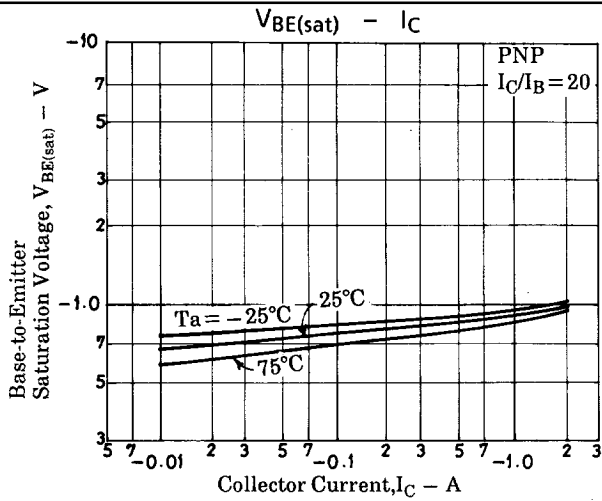

- No products described or contained herein are intended for use in surgical implants, life-support systems, aerospace equipment, nuclear power control systems, vehicles, disaster/crime-prevention equipment and the like, the failure of which may directly or indirectly cause injury, death or property loss.
- Anyone purchasing any products described or contained herein for an above-mentioned use shall:
 - ① Accept full responsibility and indemnify and defend SANYO ELECTRIC CO., LTD., its affiliates, subsidiaries and distributors and all their officers and employees, jointly and severally, against any and all claims and litigation and all damages, cost and expenses associated with such use:
 - ② Not impose any responsibility for any fault or negligence which may be cited in any such claim or litigation on SANYO ELECTRIC CO., LTD., its affiliates, subsidiaries and distributors or any of their officers and employees jointly or severally.
- Information (including circuit diagrams and circuit parameters) herein is for example only; it is not guaranteed for volume production. SANYO believes information herein is accurate and reliable, but no guarantees are made or implied regarding its use or any infringements of intellectual property rights or other rights of third parties.

This catalog provides information as of May, 1998. Specifications and information herein are subject to change without notice.