

Technische Information/technical information

IGBT-Module
IGBT-modules

FP25R12KT3

www.DataSheet4U.com

power electronics in motion

eupec

Vorläufige Daten preliminary data

IGBT-Wechselrichter/IGBT-inverter

Höchstzulässige Werte/maximum rated values

Kollektor-Emitter-Sperrspannung collector-emitter voltage	$T_{vj} = 25^{\circ}\text{C}$	V_{CES}	1200	V
Kollektor-Dauergleichstrom DC-collector current	$T_C = 80^{\circ}\text{C}$ $T_C = 25^{\circ}\text{C}$	$I_{C\ nom}$ I_C	25 40	A A
Periodischer Kollektor Spitzenstrom repetitive peak collector current	$t_P = 1\ \text{ms}$, $T_C = 80^{\circ}\text{C}$	I_{CRM}	50	A
Gesamt-Verlustleistung total power dissipation	$T_C = 25^{\circ}\text{C}$	P_{tot}	155	W
Gate-Emitter-Spitzenspannung gate-emitter peak voltage		V_{GES}	+/-20	V

Charakteristische Werte/characteristic values

			min.	typ.	max.	
Kollektor-Emitter Sättigungsspannung collector-emitter saturation voltage	$I_C = 25\ \text{A}$, $V_{GE} = 15\ \text{V}$, $T_{vj} = 25^{\circ}\text{C}$ $I_C = 25\ \text{A}$, $V_{GE} = 15\ \text{V}$, $T_{vj} = 125^{\circ}\text{C}$	$V_{CE\ sat}$		1,70 1,90	2,15	V V
Gate-Schwellenspannung gate threshold voltage	$I_C = 1,00\ \text{mA}$, $V_{CE} = V_{GE}$, $T_{vj} = 25^{\circ}\text{C}$	V_{GEth}	5,0	5,8	6,5	V
Gateladung gate charge	$V_{GE} = -15\ \text{V} \dots +15\ \text{V}$	Q_G		0,24		μC
Interner Gatewiderstand internal gate resistor	$T_{vj} = 25^{\circ}\text{C}$	R_{Gint}		8,0		Ω
Eingangskapazität input capacitance	$f = 1\ \text{MHz}$, $T_{vj} = 25^{\circ}\text{C}$, $V_{CE} = 25\ \text{V}$, $V_{GE} = 0\ \text{V}$	C_{ies}		1,80		nF
Rückwirkungskapazität reverse transfer capacitance	$f = 1\ \text{MHz}$, $T_{vj} = 25^{\circ}\text{C}$, $V_{CE} = 25\ \text{V}$, $V_{GE} = 0\ \text{V}$	C_{res}		0,064		nF
Kollektor-Emitter Reststrom collector-emitter cut-off current	$V_{CE} = 1200\ \text{V}$, $V_{GE} = 0\ \text{V}$, $T_{vj} = 25^{\circ}\text{C}$	I_{CES}			5,0	mA
Gate-Emitter Reststrom gate-emitter leakage current	$V_{CE} = 0\ \text{V}$, $V_{GE} = 20\ \text{V}$, $T_{vj} = 25^{\circ}\text{C}$	I_{GES}			400	nA
Einschaltverzögerungszeit (ind. Last) turn-on delay time (inductive load)	$I_C = 25\ \text{A}$, $V_{CE} = 600\ \text{V}$ $V_{GE} = \pm 15\ \text{V}$, $R_{Gon} = 36\ \Omega$, $T_{vj} = 25^{\circ}\text{C}$ $V_{GE} = \pm 15\ \text{V}$, $R_{Gon} = 36\ \Omega$, $T_{vj} = 125^{\circ}\text{C}$	$t_{d\ on}$		0,09 0,09		μs μs
Anstiegszeit (induktive Last) rise time (inductive load)	$I_C = 25\ \text{A}$, $V_{CE} = 600\ \text{V}$ $V_{GE} = \pm 15\ \text{V}$, $R_{Gon} = 36\ \Omega$, $T_{vj} = 25^{\circ}\text{C}$ $V_{GE} = \pm 15\ \text{V}$, $R_{Gon} = 36\ \Omega$, $T_{vj} = 125^{\circ}\text{C}$	t_r		0,03 0,05		μs μs
Abschaltverzögerungszeit (ind. Last) turn-off delay time (inductive load)	$I_C = 25\ \text{A}$, $V_{CE} = 600\ \text{V}$ $V_{GE} = \pm 15\ \text{V}$, $R_{Goff} = 36\ \Omega$, $T_{vj} = 25^{\circ}\text{C}$ $V_{GE} = \pm 15\ \text{V}$, $R_{Goff} = 36\ \Omega$, $T_{vj} = 125^{\circ}\text{C}$	$t_{d\ off}$		0,42 0,52		μs μs
Fallzeit (induktive Last) fall time (inductive load)	$I_C = 25\ \text{A}$, $V_{CE} = 600\ \text{V}$ $V_{GE} = \pm 15\ \text{V}$, $R_{Goff} = 36\ \Omega$, $T_{vj} = 25^{\circ}\text{C}$ $V_{GE} = \pm 15\ \text{V}$, $R_{Goff} = 36\ \Omega$, $T_{vj} = 125^{\circ}\text{C}$	t_f		0,07 0,09		μs μs
Einschaltverlustenergie pro Puls turn-on energy loss per pulse	$I_C = 25\ \text{A}$, $V_{CE} = 600\ \text{V}$, $L_S = 45\ \text{nH}$ $V_{GE} = \pm 15\ \text{V}$, $R_{Gon} = 36\ \Omega$, $T_{vj} = 25^{\circ}\text{C}$ $V_{GE} = \pm 15\ \text{V}$, $R_{Gon} = 36\ \Omega$, $T_{vj} = 125^{\circ}\text{C}$	E_{on}		2,40 3,50		mJ mJ
Abschaltverlustenergie pro Puls turn-off energy loss per pulse	$I_C = 25\ \text{A}$, $V_{CE} = 600\ \text{V}$, $L_S = 45\ \text{nH}$ $V_{GE} = \pm 15\ \text{V}$, $R_{Goff} = 36\ \Omega$, $T_{vj} = 25^{\circ}\text{C}$ $V_{GE} = \pm 15\ \text{V}$, $R_{Goff} = 36\ \Omega$, $T_{vj} = 125^{\circ}\text{C}$	E_{off}		1,80 2,10		mJ mJ
Kurzschlußverhalten SC data	$t_P \leq 10\ \mu\text{s}$, $V_{GE} \leq 15\ \text{V}$ $T_{vj} \leq 125^{\circ}\text{C}$, $V_{CC} = 900\ \text{V}$, $V_{CEmax} = V_{CES} - L_{sCE} \cdot di/dt$	I_{SC}		100		A
Innerer Wärmewiderstand thermal resistance, junction to case	pro IGBT per IGBT	R_{thJC}			0,80	K/W

prepared by: Andreas Schulz

date of publication: 2003-7-8

approved by: Robert Severin

revision: 2.0

Technische Information/technical information

IGBT-Module
IGBT-modules

FP25R12KT3

Vorläufige Daten
preliminary dataDiode-Wechselrichter/diode-inverter
Höchstzulässige Werte/maximum rated values

Periodische Spitzensperrspannung repetitive peak reverse voltage	$T_{vj} = 25^{\circ}\text{C}$	V_{RRM}	1200	V
Dauergleichstrom DC forward current		I_F	25	A
Periodischer Spitzenstrom repetitive peak forward current	$t_p = 1 \text{ ms}$	I_{FRM}	50	A
Grenzlastintegral I^2t - value	$V_R = 0 \text{ V}, t_p = 10 \text{ ms}, T_{vj} = 125^{\circ}\text{C}$	I^2t	170	A^2s

Charakteristische Werte/characteristic values

			min.	typ.	max.	
Durchlassspannung forward voltage	$I_F = 25 \text{ A}, V_{GE} = 0 \text{ V}, T_{vj} = 25^{\circ}\text{C}$ $I_F = 25 \text{ A}, V_{GE} = 0 \text{ V}, T_{vj} = 125^{\circ}\text{C}$	V_F		1,65 1,65	2,15	V V
Rückstromspitze peak reverse recovery current	$I_F = 25 \text{ A}, -di_F/dt = 700 \text{ A}/\mu\text{s}$ $V_R = 600 \text{ V}, V_{GE} = -15 \text{ V}, T_{vj} = 25^{\circ}\text{C}$ $V_R = 600 \text{ V}, V_{GE} = -15 \text{ V}, T_{vj} = 125^{\circ}\text{C}$	I_{RM}		26,0 24,0		A A
Sperrverzögerungsladung recovered charge	$I_F = 25 \text{ A}, -di_F/dt = 700 \text{ A}/\mu\text{s}$ $V_R = 600 \text{ V}, V_{GE} = -15 \text{ V}, T_{vj} = 25^{\circ}\text{C}$ $V_R = 600 \text{ V}, V_{GE} = -15 \text{ V}, T_{vj} = 125^{\circ}\text{C}$	Q_r		2,80 5,00		μC μC
Abschaltenergie pro Puls reverse recovery energy	$I_F = 25 \text{ A}, -di_F/dt = 700 \text{ A}/\mu\text{s}$ $V_R = 600 \text{ V}, V_{GE} = -15 \text{ V}, T_{vj} = 25^{\circ}\text{C}$ $V_R = 600 \text{ V}, V_{GE} = -15 \text{ V}, T_{vj} = 125^{\circ}\text{C}$	E_{rec}		0,90 1,80		mJ mJ
Innerer Wärmewiderstand thermal resistance, junction to case	pro Diode per diode	R_{thJC}			1,35	K/W

Diode-Gleichrichter/diode-rectifier

Höchstzulässige Werte/maximum rated values

Periodische Rückw. Spitzensperrspannung repetitive peak reverse voltage	$T_{vj} = 25^{\circ}\text{C}$	V_{RRM}	1600	V
Durchlassstrom Grenzeffektivwert pro Dio. forward current RMS maximum per diode	$T_C = 80^{\circ}\text{C}$	I_{FRMSM}	50	A
Gleichrichter Ausgang Grenzeffektivstrom maximum RMS current at Rectifier output	$T_C = 80^{\circ}\text{C}$	I_{RMSM}	60	A
Stoßstrom Grenzwert surge forward current	$t_p = 10 \text{ ms}, T_{vj} = 25^{\circ}\text{C}$ $t_p = 10 \text{ ms}, T_{vj} = 150^{\circ}\text{C}$	I_{FSM}	315 260	A A
Grenzlastintegral I^2t - value	$t_p = 10 \text{ ms}, T_{vj} = 25^{\circ}\text{C}$ $t_p = 10 \text{ ms}, T_{vj} = 150^{\circ}\text{C}$	I^2t	495 340	A^2s A^2s

Charakteristische Werte/characteristic values

			min.	typ.	max.	
Durchlassspannung forward voltage	$T_{vj} = 150^{\circ}\text{C}, I_F = 25 \text{ A}$	V_F		1,05		V
Sperrstrom reverse current	$T_{vj} = 150^{\circ}\text{C}, V_R = 1600 \text{ V}$	I_R		2,00		mA
Innerer Wärmewiderstand thermal resistance, junction to case	pro Diode per diode	R_{thJC}			1,00	K/W

prepared by: Andreas Schulz

date of publication: 2003-7-8

approved by: Robert Severin

revision: 2.0

Technische Information/technical information

IGBT-Module
IGBT-modules

FP25R12KT3

www.DataSheet4U.com

power electronics in motion

eupec

Vorläufige Daten preliminary data

IGBT-Brems-Chopper/IGBT-brake-chopper

Höchstzulässige Werte/maximum rated values

Kollektor-Emitter-Sperrspannung collector-emitter voltage	$T_{vj} = 25^{\circ}\text{C}$	V_{CES}	1200	V
Kollektor-Dauergleichstrom DC-collector current	$T_c = 80^{\circ}\text{C}$ $T_c = 25^{\circ}\text{C}$	I_{Cnom} I_C	15 25	A A
Periodischer Kollektor Spitzenstrom repetitive peak collector current	$t_P = 1 \text{ ms}, T_c = 80^{\circ}\text{C}$	I_{CRM}	30	A
Gesamt-Verlustleistung total power dissipation	$T_c = 25^{\circ}\text{C}$	P_{tot}	105	W
Gate-Emitter-Spitzenspannung gate-emitter peak voltage		V_{GES}	+/-20	V

Charakteristische Werte/characteristic values

			min.	typ.	max.	
Kollektor-Emitter Sättigungsspannung collector-emitter saturation voltage	$I_C = 15 \text{ A}, V_{GE} = 15 \text{ V}, T_{vj} = 25^{\circ}\text{C}$ $I_C = 15 \text{ A}, V_{GE} = 15 \text{ V}, T_{vj} = 125^{\circ}\text{C}$	$V_{CE sat}$		1,70 1,90	2,15	V V
Gate-Schwellenspannung gate threshold voltage	$I_C = 0,50 \text{ mA}, V_{CE} = V_{GE}, T_{vj} = 25^{\circ}\text{C}$	V_{GEth}	5,0	5,8	6,5	V
Gateladung gate charge	$V_{GE} = -15 \text{ V} \dots +15 \text{ V}$	Q_G		0,15		μC
Interner Gatewiderstand internal gate resistor		R_{Gint}		0,00		Ω
Eingangskapazität input capacitance	$f = 1 \text{ MHz}, T_{vj} = 25^{\circ}\text{C}$ $V_{CE} = 25 \text{ V}, V_{GE} = 0 \text{ V}$	C_{ies}		1,10		nF
Rückwirkungskapazität reverse transfer capacitance	$f = 1 \text{ MHz}, T_{vj} = 25^{\circ}\text{C}$ $V_{CE} = 25 \text{ V}, V_{GE} = 0 \text{ V}$	C_{res}		0,04		nF
Kollektor-Emitter Reststrom collector-emitter cut-off current	$V_{CE} = 1200 \text{ V}, V_{GE} = 0 \text{ V}, T_{vj} = 25^{\circ}\text{C}$	I_{CES}			5,0	mA
Gate-Emitter Reststrom gate-emitter leakage current	$V_{CE} = 0 \text{ V}, V_{GE} = 20 \text{ V}, T_{vj} = 25^{\circ}\text{C}$	I_{GES}			400	nA
Einschaltverzögerungszeit (ind. Last) turn-on delay time (inductive load)	$I_C = 15 \text{ A}, V_{CE} = 600 \text{ V}$ $V_{GE} = \pm 15 \text{ V}, R_{Gon} = 75 \Omega, T_{vj} = 25^{\circ}\text{C}$ $V_{GE} = \pm 15 \text{ V}, R_{Gon} = 75 \Omega, T_{vj} = 125^{\circ}\text{C}$	$t_{d on}$		0,09 0,09		μs μs
Anstiegszeit (induktive Last) rise time (inductive load)	$I_C = 15 \text{ A}, V_{CE} = 600 \text{ V}$ $V_{GE} = \pm 15 \text{ V}, R_{Gon} = 75 \Omega, T_{vj} = 25^{\circ}\text{C}$ $V_{GE} = \pm 15 \text{ V}, R_{Gon} = 75 \Omega, T_{vj} = 125^{\circ}\text{C}$	t_r		0,03 0,05		μs μs
Abschaltverzögerungszeit (ind. Last) turn-off delay time (inductive load)	$I_C = 15 \text{ A}, V_{CE} = 600 \text{ V}$ $V_{GE} = \pm 15 \text{ V}, R_{Goff} = 75 \Omega, T_{vj} = 25^{\circ}\text{C}$ $V_{GE} = \pm 15 \text{ V}, R_{Goff} = 75 \Omega, T_{vj} = 125^{\circ}\text{C}$	$t_{d off}$		0,42 0,52		μs μs
Fallzeit (induktive Last) fall time (inductive load)	$I_C = 15 \text{ A}, V_{CE} = 600 \text{ V}$ $V_{GE} = \pm 15 \text{ V}, R_{Goff} = 75 \Omega, T_{vj} = 25^{\circ}\text{C}$ $V_{GE} = \pm 15 \text{ V}, R_{Goff} = 75 \Omega, T_{vj} = 125^{\circ}\text{C}$	t_f		0,07 0,09		μs μs
Einschaltverlustenergie pro Puls turn-on energy loss per pulse	$I_C = 15 \text{ A}, V_{CE} = 600 \text{ V}$ $V_{GE} = \pm 15 \text{ V}, R_{Gon} = 75 \Omega, T_{vj} = 25^{\circ}\text{C}$ $V_{GE} = \pm 15 \text{ V}, R_{Gon} = 75 \Omega, T_{vj} = 125^{\circ}\text{C}$	E_{on}		1,50 2,10		mJ mJ
Abschaltverlustenergie pro Puls turn-off energy loss per pulse	$I_C = 15 \text{ A}, V_{CE} = 600 \text{ V}$ $V_{GE} = \pm 15 \text{ V}, R_{Goff} = 75 \Omega, T_{vj} = 25^{\circ}\text{C}$ $V_{GE} = \pm 15 \text{ V}, R_{Goff} = 75 \Omega, T_{vj} = 125^{\circ}\text{C}$	E_{off}		1,10 1,30		mJ mJ
Kurzschlußverhalten SC data	$t_P \leq 10 \mu\text{sec}, V_{GE} \leq 15 \text{ V}$ $T_{vj} \leq 125^{\circ}\text{C}, V_{CC} = 900 \text{ V}, V_{CEmax} = V_{CES} - L_{sCE} \cdot di/dt$	I_{SC}		60		A
Innerer Wärmewiderstand thermal resistance, junction to case	pro IGBT per IGBT	R_{thJC}			1,20	K/W

prepared by: Andreas Schulz

date of publication: 2003-7-8

approved by: Robert Severin

revision: 2.0

Technische Information/technical information

IGBT-Module
IGBT-modules

FP25R12KT3

www.DataSheet4U.com

power electronics in motion

eupec

Vorläufige Daten preliminary data

Diode-Brems-Chopper/Diode-brake-chopper Höchstzulässige Werte/maximum rated values

Periodische Spitzensperrspannung repetitive peak reverse voltage	$T_{vj} = 25^{\circ}\text{C}$	V_{RRM}	1200	V
Dauergleichstrom DC forward current		I_F	10	A
Periodischer Spitzenstrom repetitive peak forw. current	$t_p = 1 \text{ ms}$	I_{FRM}	20	A
Grenzlastintegral I^2t - value	$V_R = 0 \text{ V}, t_p = 10 \text{ ms}, T_{vj} = 125^{\circ}\text{C}$	I^2t	20,0	A^2s

Charakteristische Werte/characteristic values

			min.	typ.	max.	
Durchlaßspannung forward voltage	$I_F = 10 \text{ A}, V_{GE} = 0 \text{ V}, T_{vj} = 25^{\circ}\text{C}$ $I_F = 10 \text{ A}, V_{GE} = 0 \text{ V}, T_{vj} = 125^{\circ}\text{C}$	V_F		1,80 1,85	2,25	V V
Rückstromspitze peak reverse recovery current	$I_F = 10 \text{ A}, -di_F/dt = 400 \text{ A}/\mu\text{s}$ $V_R = 600 \text{ V}, V_{GE} = -15 \text{ V}, T_{vj} = 25^{\circ}\text{C}$ $V_R = 600 \text{ V}, V_{GE} = -15 \text{ V}, T_{vj} = 125^{\circ}\text{C}$	I_{RM}		14,0 15,0		A A
Sperrverzögerungsladung recovered charge	$I_F = 10 \text{ A}, -di_F/dt = 400 \text{ A}/\mu\text{s}$ $V_R = 600 \text{ V}, V_{GE} = -15 \text{ V}, T_{vj} = 25^{\circ}\text{C}$ $V_R = 600 \text{ V}, V_{GE} = -15 \text{ V}, T_{vj} = 125^{\circ}\text{C}$	Q_r		1,00 1,80		μC μC
Abschaltenergie pro Puls reverse recovery energy	$I_F = 10 \text{ A}, -di_F/dt = 400 \text{ A}/\mu\text{s}$ $V_R = 600 \text{ V}, V_{GE} = -15 \text{ V}, T_{vj} = 25^{\circ}\text{C}$ $V_R = 600 \text{ V}, V_{GE} = -15 \text{ V}, T_{vj} = 125^{\circ}\text{C}$	E_{rec}		0,26 0,56		mJ mJ
Innerer Wärmewiderstand thermal resistance, junction to case	pro Diode per diode	R_{thJC}			2,30	K/W

NTC-Widerstand/NTC-thermistor

Charakteristische Werte/characteristic values

			min.	typ.	max.	
Nennwiderstand rated resistance	$T_C = 25^{\circ}\text{C}$	R_{25}		5,00		$\text{k}\Omega$
Abweichung von R_{100} deviation of R_{100}	$T_C = 100^{\circ}\text{C}, R_{100} = 493 \Omega$	$\Delta R/R$	-5		5	%
Verlustleistung power dissipation	$T_C = 25^{\circ}\text{C}$	P_{25}			20,0	mW
B-Wert B-value	$R_2 = R_{25} \exp [B_{25/50}(1/T_2 - 1/(298, 15\text{K}))]$	$B_{25/50}$		3375		K

prepared by: Andreas Schulz	date of publication: 2003-7-8
approved by: Robert Severin	revision: 2.0

Technische Information/technical information

IGBT-Module
IGBT-modules

FP25R12KT3

www.DataSheet4U.com

power electronics in motion

eupec

Vorläufige Daten preliminary data

Modul/module

Isolations-Prüfspannung insulation test voltage	RMS, f = 50 Hz, t = 1 min.	V _{ISO}	2,5		kV
Material Modulgrundplatte material of module baseplate			Cu		
Material für innere Isolation material for internal insulation			Al ₂ O ₃		
Kriechstrecke creepage distance	Kontakt - Kühlkörper / terminal to heatsink Kontakt - Kontakt / terminal to terminal		10,0		mm
Luftstrecke clearance distance	Kontakt - Kühlkörper / terminal to heatsink Kontakt - Kontakt / terminal to terminal		7,50		mm
Vergleichszahl der Kriechwegbildung comparative tracking index		CTI	> 225		
			min.	typ.	max.
Übergangs-Wärmewiderstand thermal resistance, case to heatsink	pro Modul / per module $\lambda_{\text{Paste}} = 1 \text{ W}/(\text{m}\cdot\text{K}) / \lambda_{\text{grease}} = 1 \text{ W}/(\text{m}\cdot\text{K})$	R _{thCH}	0,02		K/W
Modulinduktivität stray inductance module		L _{sCE}	60		nH
Modulleitungswiderstand, Anschlüsse - Chip module lead resistance, terminals - chip	T _C = 25°C, pro Schalter / per switch	R _{CC'+EE'} R _{AA'+CC'}	4,00 3,00		mΩ
Höchstzulässige Sperrschichttemperatur maximum junction temperature		T _{vj max}			150 °C
Temperatur im Schaltbetrieb temperature under switching conditions		T _{vj op}	-40		125 °C
Lagertemperatur storage temperature		T _{stg}	-40		125 °C
Anzugsdrehmoment f. mech. Befestigung mounting torque	Schraube / screw M5	M	3,00	-	6,00 Nm
Gewicht weight		G	180		g

www.DataSheet4U.com

Mit dieser technischen Information werden Halbleiterbauelemente spezifiziert, jedoch keine Eigenschaften zugesichert. Sie gilt in Verbindung mit den zugehörigen technischen Erläuterungen.

This technical information specifies semiconductor devices but guarantees no characteristics. It is valid with the appropriate technical explanations.

prepared by: Andreas Schulz	date of publication: 2003-7-8
approved by: Robert Severin	revision: 2.0

Vorläufige Daten
preliminary data

Ausgangskennlinie IGBT-Wechselr. (typisch)
output characteristic IGBT-inverter (typical)

$I_c = f(V_{CE})$
 $V_{GE} = 15\text{ V}$

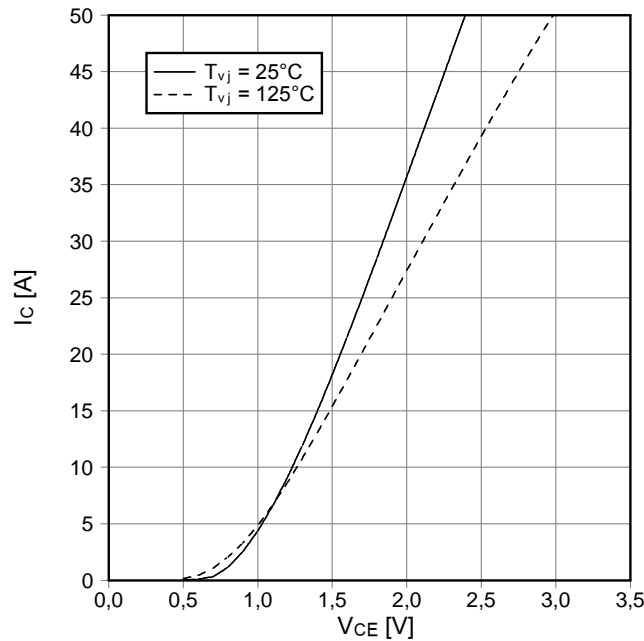

Ausgangskennlinienfeld IGBT-Wechselr. (typisch)
output characteristic IGBT-inverter (typical)

$I_c = f(V_{CE})$
 $T_{vj} = 125^\circ\text{C}$

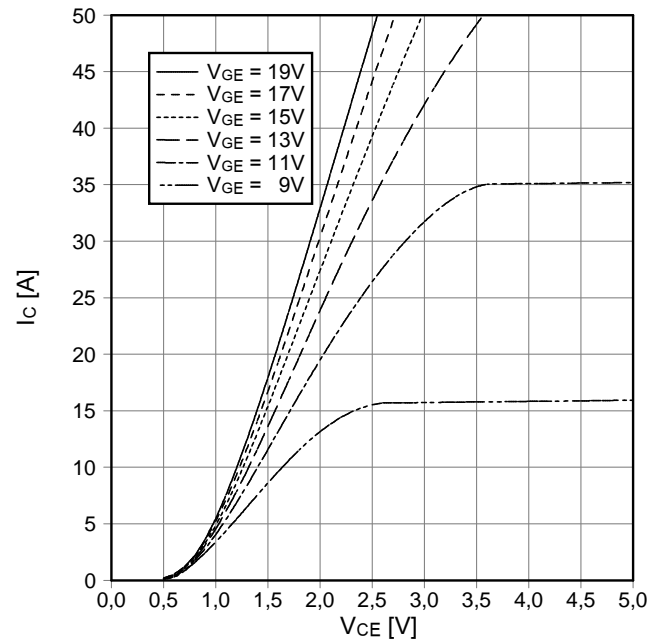

Übertragungscharakteristik IGBT-Wechselr. (typisch)
transfer characteristic IGBT-inverter (typical)

$I_c = f(V_{GE})$
 $V_{CE} = 20\text{ V}$

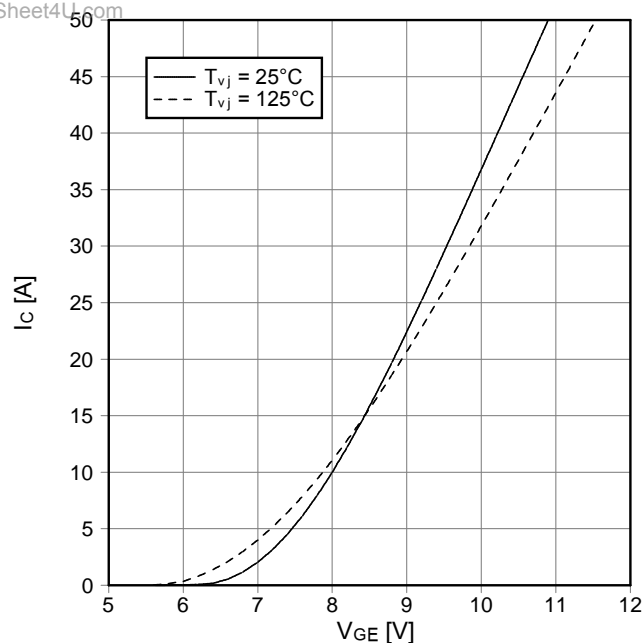

Schaltverluste IGBT-Wechselr. (typisch)
switching losses IGBT-inverter (typical)

$E_{on} = f(I_c)$, $E_{off} = f(I_c)$
 $V_{GE} = \pm 15\text{ V}$, $R_{Gon} = 36\ \Omega$, $R_{Goff} = 36\ \Omega$, $V_{CE} = 600\text{ V}$,
 $T_{vj} = 125^\circ\text{C}$

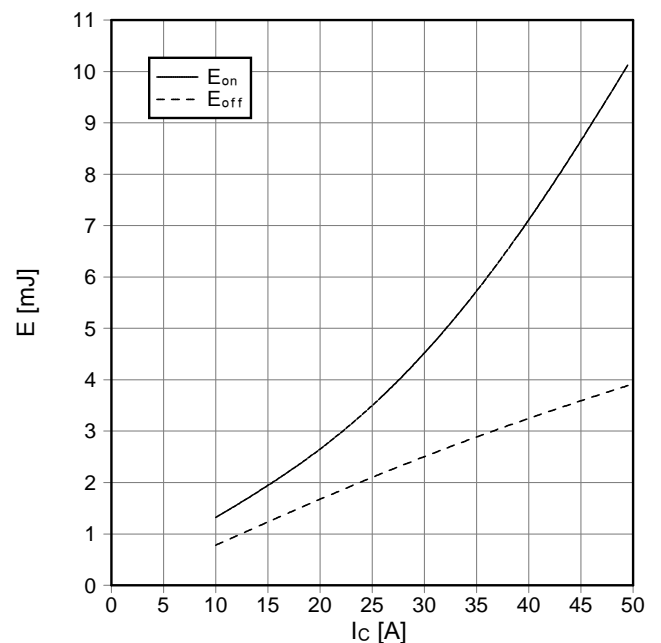

Vorläufige Daten
preliminary data

Schaltverluste IGBT-Wechselr. (typisch)
switching losses IGBT-Inverter (typical)
 $E_{on} = f(R_G)$, $E_{off} = f(R_G)$
 $V_{GE} = \pm 15\text{ V}$, $I_c = 25\text{ A}$, $V_{CE} = 600\text{ V}$, $T_{vj} = 125^\circ\text{C}$

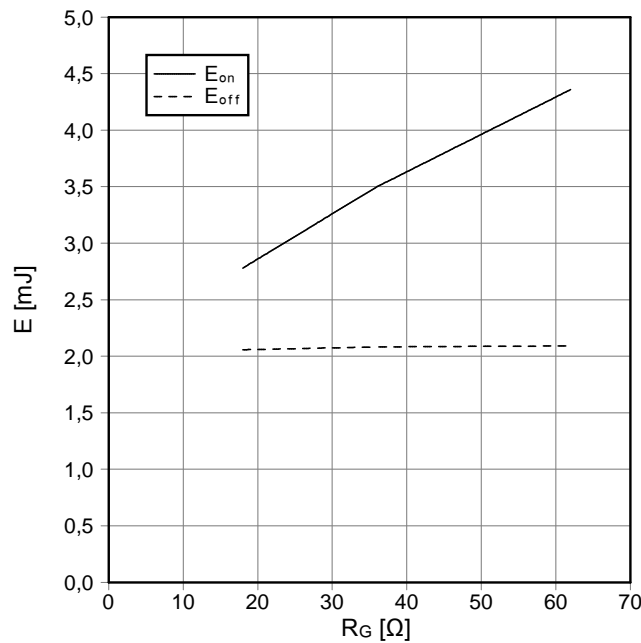

Transienter Wärmewiderstand IGBT-Wechselr.
transient thermal impedance IGBT-inverter
 $Z_{thJC} = f(t)$

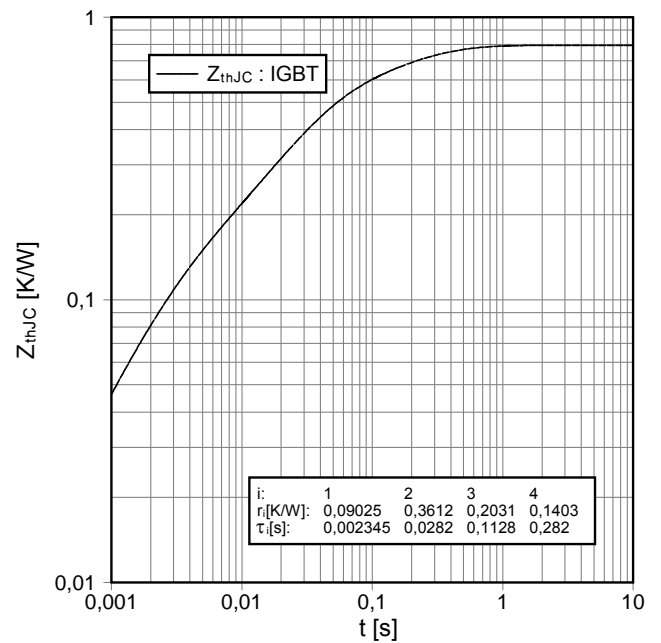

Sicherer Rückwärts-Arbeitsbereich IGBT-Wr. (RBSOA)
reverse bias safe operating area IGBT-inv. (RBSOA)
 $I_c = f(V_{CE})$
 $V_{GE} = \pm 15\text{ V}$, $R_{Goff} = 36\ \Omega$, $T_{vj} = 125^\circ\text{C}$

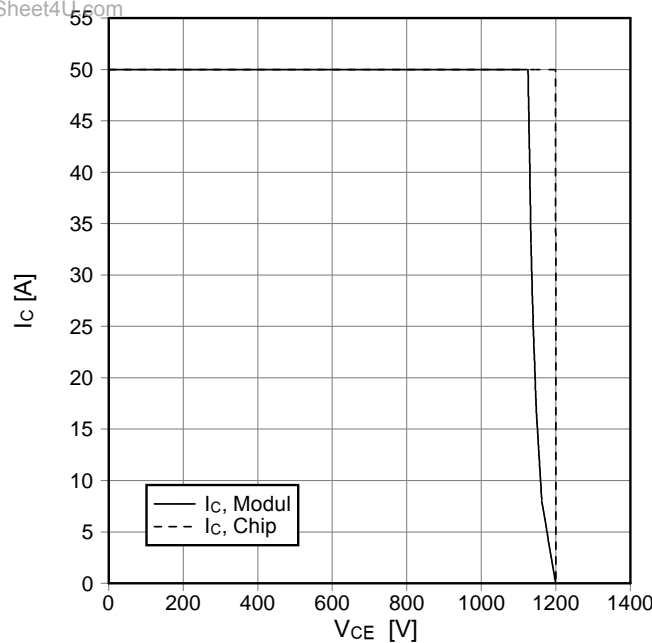

Durchlaßkennlinie der Diode-Wechselr. (typisch)
forward characteristic of diode-inverter (typical)
 $I_F = f(V_F)$

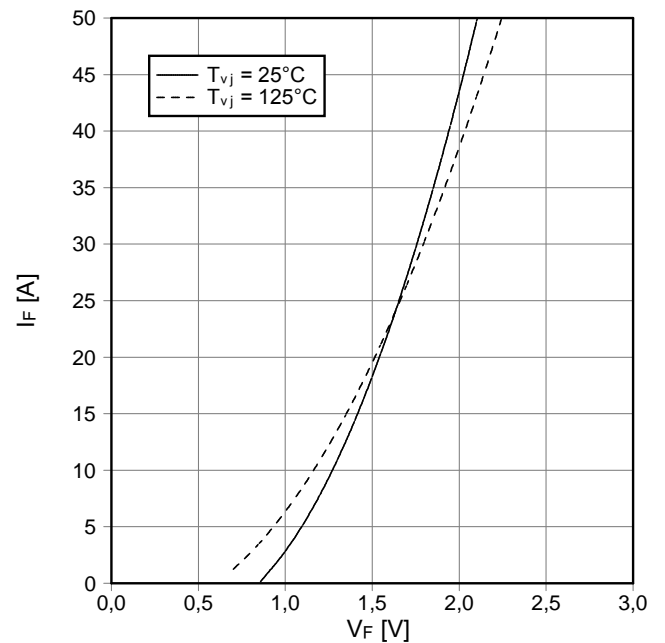

prepared by: Andreas Schulz	date of publication: 2003-7-8
approved by: Robert Severin	revision: 2.0

Vorläufige Daten
preliminary data

Schaltverluste Diode-Wechselr. (typisch)
switching losses diode-inverter (typical)

$E_{rec} = f(I_F)$
 $R_{Gon} = 36 \Omega$, $V_{CE} = 600 V$, $T_{vj} = 125^\circ C$

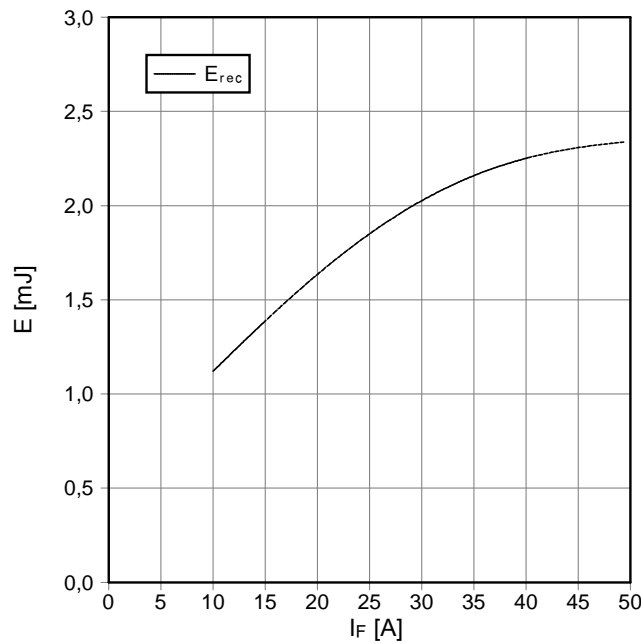

Schaltverluste Diode-Wechselr. (typisch)
switching losses diode-inverter (typical)

$E_{rec} = f(R_G)$
 $I_F = 25 A$, $V_{CE} = 600 V$, $T_{vj} = 125^\circ C$

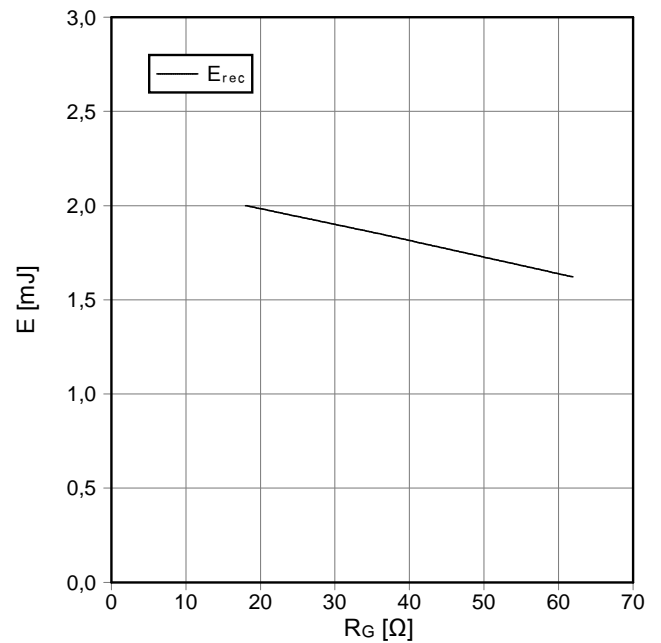

Transienter Wärmewiderstand Diode-Wechselr.
transient thermal impedance diode-inverter

$Z_{thJC} = f(t)$

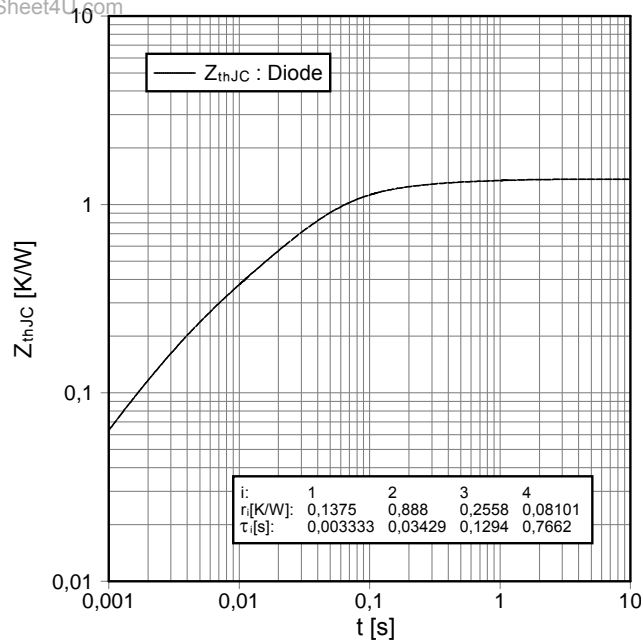

i:	1	2	3	4
r_i [K/W]:	0,1375	0,888	0,2558	0,08101
τ_i [s]:	0,003333	0,03429	0,1294	0,7662

Durchlaßkennlinie der Diode-Gleichrichter (typisch)
forward characteristic of diode-rectifier (typical)

$I_F = f(V_F)$

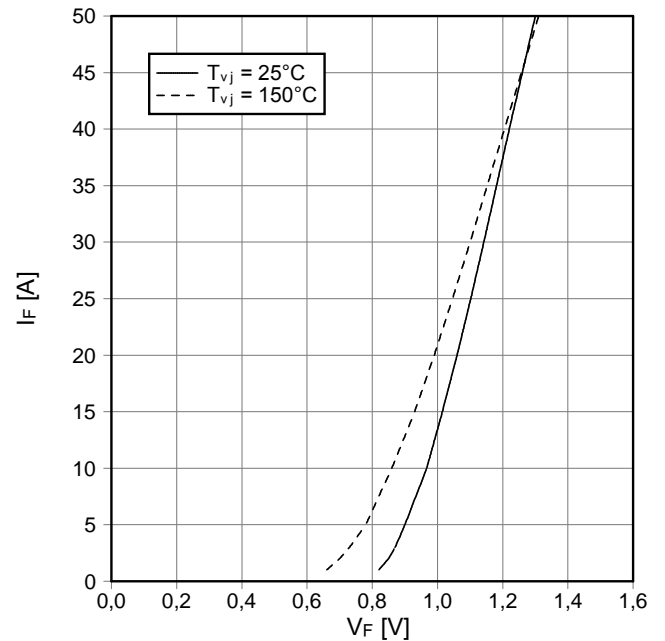

prepared by: Andreas Schulz	date of publication: 2003-7-8
approved by: Robert Severin	revision: 2.0

Vorläufige Daten
preliminary data

Ausgangskennlinie IGBT-Brems-Chopper (typisch)
output characteristic IGBT-brake-chopper (typical)

$I_C = f(V_{CE})$
 $V_{GE} = 15 \text{ V}$

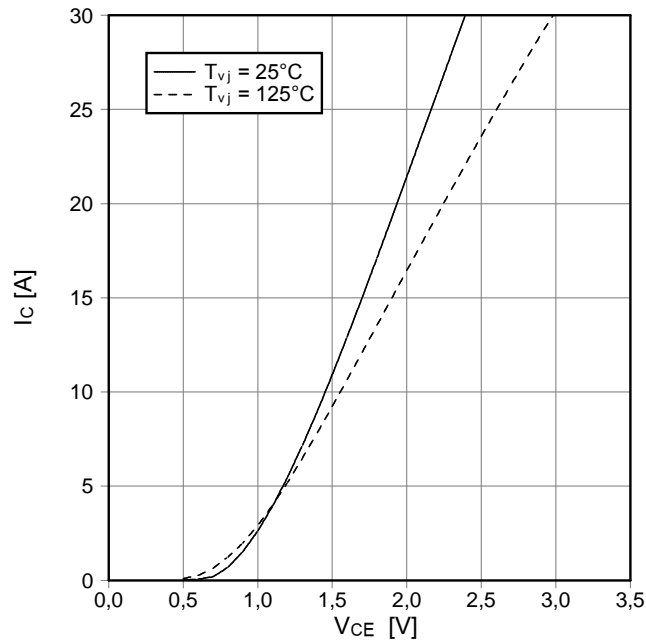

Durchlaßkennlinie der Diode-Brems-Chopper (typisch)
forward characteristic of diode-brake-chopper (typical)

$I_F = f(V_F)$

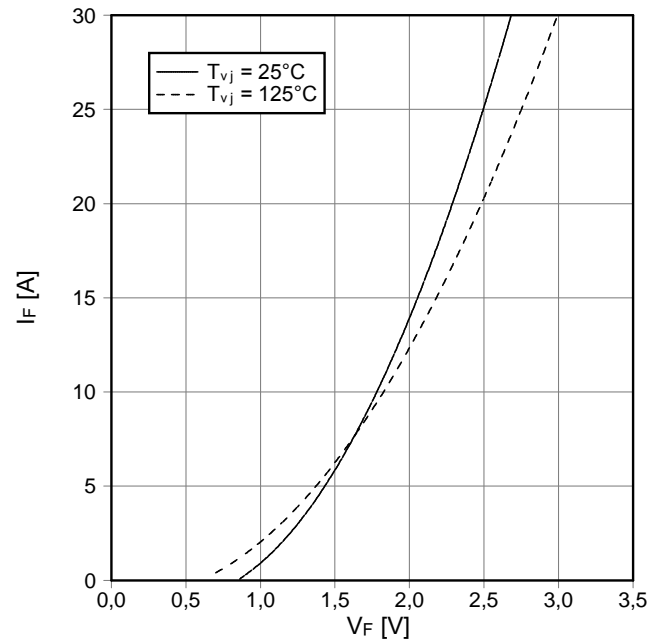

NTC-Temperaturkennlinie (typisch)
NTC-temperature characteristic (typical)

$R = f(T)$

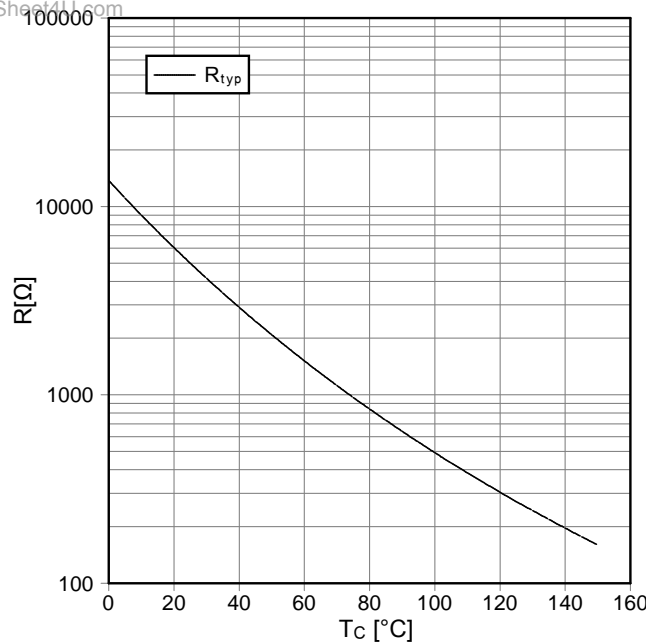

prepared by: Andreas Schulz	date of publication: 2003-7-8
approved by: Robert Severin	revision: 2.0

Vorläufige Daten
preliminary data

Schaltplan/circuit diagram

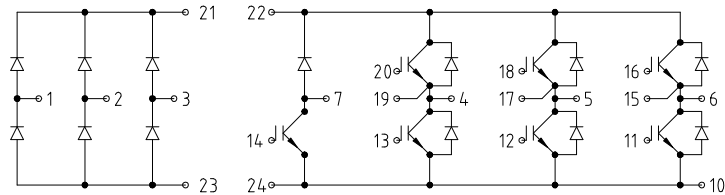

Gehäuseabmessungen/package outlines

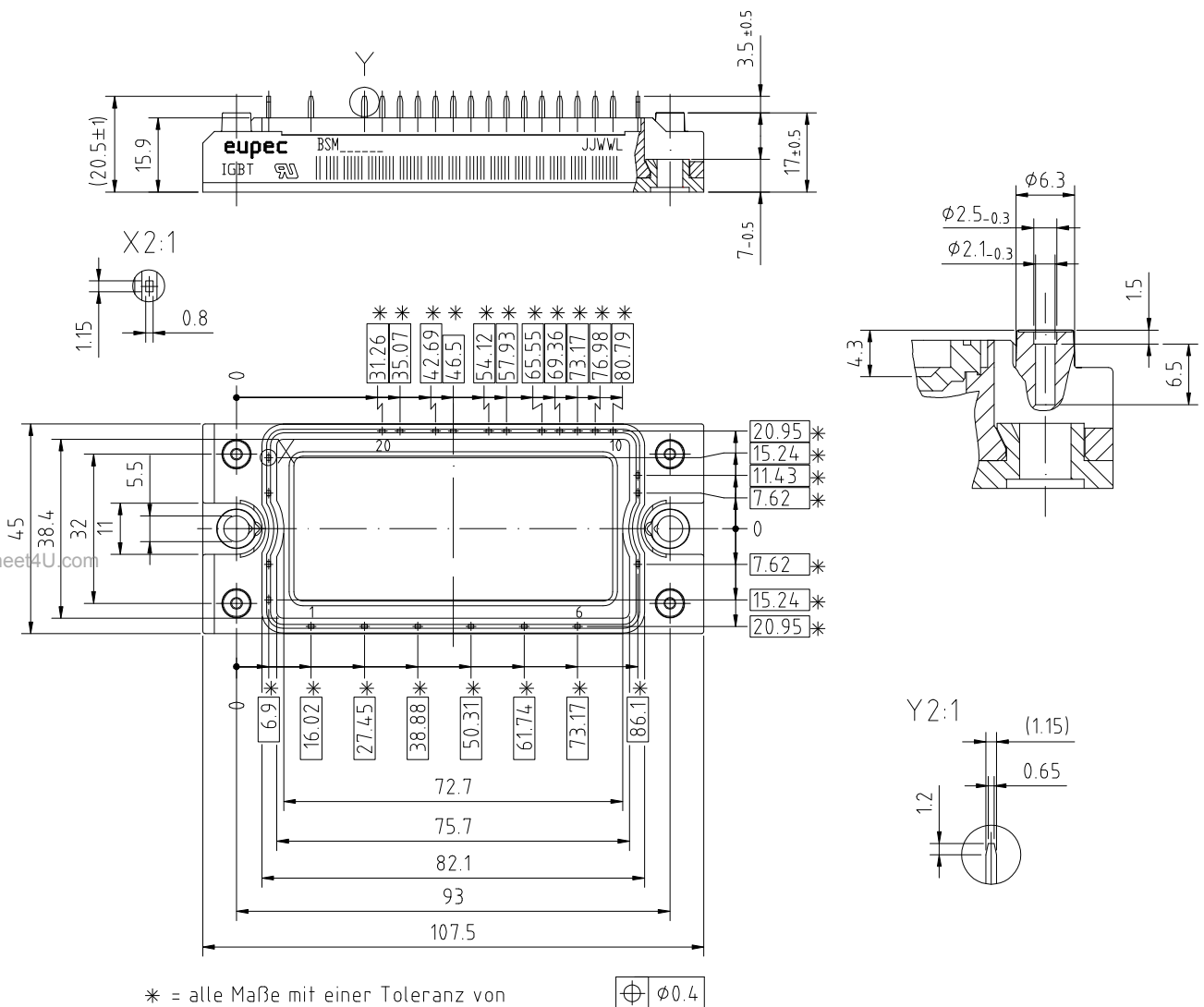

prepared by: Andreas Schulz	date of publication: 2003-7-8
approved by: Robert Severin	revision: 2.0

Terms & Conditions of Usage

Attention

The present product data is exclusively subscribed to technically experienced staff. This Data Sheet is describing the specification of the products for which a warranty is granted exclusively pursuant the terms and conditions of the supply agreement. There will be no guarantee of any kind for the product and its specifications. Changes to the Data Sheet are reserved.

You and your technical departments will have to evaluate the suitability of the product for the intended application and the completeness of the product data with respect to such application. Should you require product information in excess of the data given in the Data Sheet, please contact your local Sales Office via "www.eupec.com / sales & contact".

Warning

Due to technical requirements the products may contain dangerous substances. For information on the types in question please contact your local Sales Office via "www.eupec.com / sales & contact".